



# **Soodar User Manual**

*Release 21.11*

**Soodar**

**Jun 10, 2023**



# CONTENTS:

- 1 Soodar User Guide** **1**
- 1.1 Introduction . . . . . 1
- 1.2 Basics . . . . . 2
- 1.3 Tune . . . . . 46
- 1.4 Protocols . . . . . 53
- 1.5 NAT . . . . . 172
- 1.6 Qos . . . . . 175
- 1.7 Access Control List . . . . . 177
- 1.8 VRF . . . . . 181
- 1.9 MPLS . . . . . 182
- 1.10 Security . . . . . 183
- 1.11 L2 Features . . . . . 205
  
- 2 Indices and tables** **211**
  
- Bibliography** **213**
  
- Index** **215**



## SODAR USER GUIDE

### 1.1 Introduction

#### 1.1.1 Overview

Sodar, new generation of high-capacity, enterprise, core routers, is a recent product in network's industry. Using the latest technologies and improvements in network's domain, make it a robust and reliable choice for being employed in network designs. Implementing a Cisco-wise CLI in control plane and providing a wide range of monitoring tools, ease network administrators getting familiar with product and make them more comfortable with it. The data plane, is the beating heart of Sodar. Equipping a fully-optimized software based data plane with Sodar assures high throughput on router.

Sodar can be used in vast different networks, but it is highly optimized to be used as a router in:

- MPLS core networks
- IPv4/6 core networks
- Data centers

The heart of Sodar, is its operator system. SodarOS.

#### SodarOS

SodarOS is a routing operating system based on linux, that provides a reliable control-plane and a fast, software based data-plane with all state-of-the-art technologies.

To achieve this, SodarOS leverages two known software suites:

- FRR for control-plane
- VPP for data-plane

FRR is a software suite that provides TCP/IP based routing services with routing protocols support such as BGP, RIP, OSPF, IS-IS and more . FRR also supports special BGP Route Reflector and Route Server behavior. In addition to traditional IPv4 routing protocols, FRR also supports IPv6 routing protocols.

VPP is an extensible framework that provides out-of-the-box production quality switch/router functionality. It is a high performance, packet-processing stack that can run on commodity CPUs with a rich feature set.

SodarOS uses an advanced software architecture to provide you with a high quality router. SodarOS has an interactive user interface and supports common client commands.

## Architecture

The following figure, shows SoodarOS components and their relationship

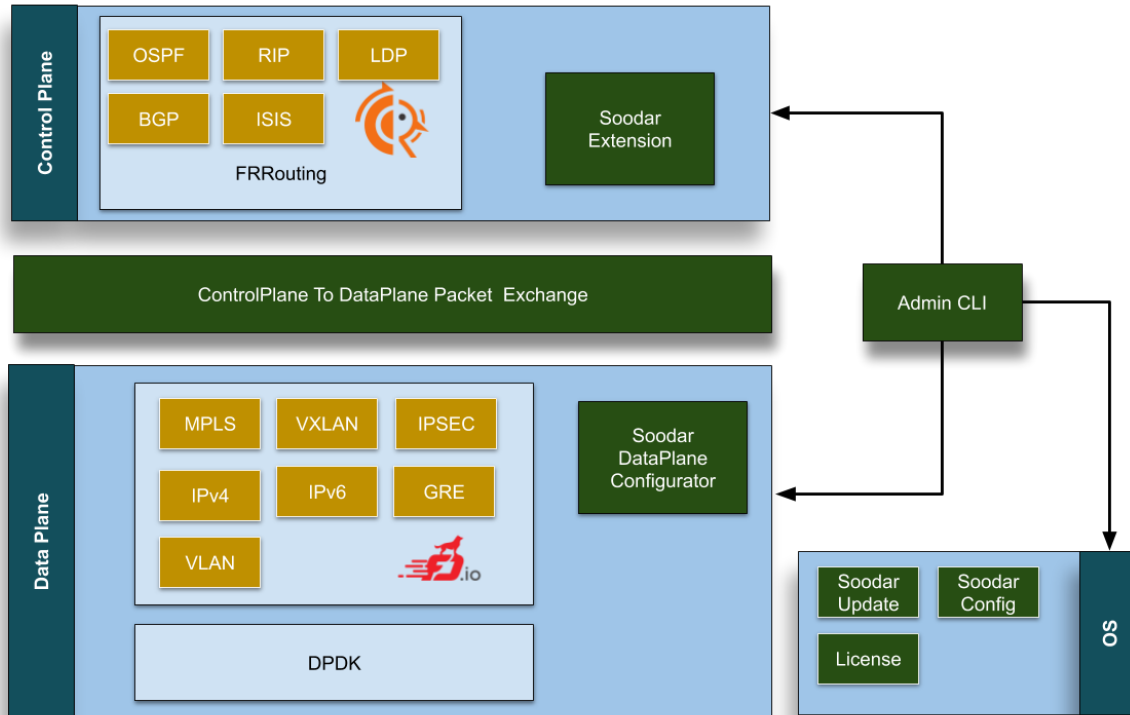

## 1.2 Basics

### 1.2.1 Modes and user's configurations

#### Connect to SoodarOS

There are 3 ways of connecting to router for configuring:

- **Physical connection:**
  1. Direct connection( via monitor and keyboard)
  2. Console connection( RS-232)
- **Remote connection:**
  1. SSH connection

## Remote connection

Using well-known *SSH Protocol*, enabled router remote access.

Example : Having a management interface with address 192.168.1.1/24:

```
m@m-pc:~$ ssh admin@192.168.1.1
admin@192.168.1.1's password:
```

## Users

Currently, only one *admin* user is available, named *admin*. It is the username that is used with *SSH* connection.

## Modes

- **View mode** Admin has access to some **show** commands to view the router's state.
- **Enable mode:** Admin can't change the router's configs. But he can enable *debug* commands and some more privileged commands than *view mode*
- **Config mode:** Full access to the router.

## Passwords

SoodarOS is protected by 3 levels of passwords:

1. Access password
2. Enable password
3. Config password

### Access password

It's the primary password to log in with the user. Without having the access password, a person can't have any access to the router. An admin with knowing only *access password* is an admin with just *view mode* privilege.

#### **password**

Change access password

### Enable password

Put an admin in *enable mode*. It is asked when the admin issues the **enable** command.

#### **enable password PASSWORD**

Set enable password

#### **no enable password PASSWORD**

Disable enable password.

## Config password

Is asked when the admin inputs `configure` in the command line to enter *config mode*.

**enable config password PASSWORD**

Set config password

**no enable config password PASSWORD**

Disable config password

## Reset access password

In case access password is forgotten, connect to soodar via *console* and enter `user password`

**user password**

Reset access password. enabled when connected through physical access.

## Password length

To force users to set strong passwords, admin can set a minimum length for passwords.

**security passwords min-length**

Apply a minimum password length policy to the system. Default of 8 characters is set as passwords' minimum length.

```
soodar(config)# security password min-length 8
```

**no security passwords min-length**

Remove all restrictions about password length.

## Login Failures

Admin can ask for details of failed logins. These details are:

**User name:** The user who was tried to log in to( currently just admin) **Medium:** Whether it was through SSH or Console **Address:** In case of the remote login attempt, IP address of the initiator machine. Else it's *0.0.0.0*. **Date:** Attempting date

**show login failures**

Example:

```
soodar# show login failures
admin  ssh:notty      192.168.1.13    Thu Sep 17 09:18
admin  ssh:notty      192.168.1.13    Thu Sep 17 09:18
admin  ssh:notty      192.168.1.13    Thu Sep 17 09:18
```

---

**Note:** Login logs are stored only for 1 month.

---



## Session Management

SoodarOS' admin can protect the router from DoS attacks and prevent network exhaustion by limiting the SSH authentication tries in a period and blocking the abuser's IP. Also, he can see currently established sessions and terminate them.

### **show users**

Show current running sessions. Includes line number, session type( console or SSH), session ID, and IP address of the remote user

### **clear line (0-530)**

Clear a TTY line and make it usable by terminating the session on that line.

---

**Note:** Clearing a line causes all sessions with the same session ID as the cleared session to terminate. In a normal situation, each line has its session ID. But if multiple sessions are run on a single SSH connection, they share the same session ID

---

### **login block-for TIME attempts ATTEMPT within PERIOD**

Set SSH jailing parameters. If someone tries ``ATTEMPT``( a number in 1 to 10 range) unsuccessful login attempts within ``PERIOD``( [30-600]) seconds, his IP address will be limited for next ``TIME``([10-7200]) seconds. Default values are 600 seconds of jail time for 5 attempts in 30 seconds.

### **show login blocked-ips**

Show in jail IPs.

### **login unblock <A.B.C.D|X:X::X:X|all>**

Unblock an IP and release it from jail. Admin can unblock all blocked IPs with all as command input.

## MOTD

Sometimes system administrator needs to set a message, so every user attempting to log in can see it. This could be done by setting a MOTD banner.

### **banner motd line LINE**

Set motd string from an input.

### **no banner motd**

No MOTD banner string is printed.

## SSH

Soodar serves as a client for the SSH and as an SSH server. Therefore, key management options are provided to users.

## SSH Server

### ip ssh pubkey-chain

Enter SSH server authorized keys management node.

### username USER

Enter authorized public key management node for a user. Any SSH connection attempt to the user with an authorized public key is accepted.

### key LINE ..

Add a public key to the user's authorized keys.

### no key HASH

Remove a public key from the user's authorized keys by its hash.

### no key (1-65535)

Remove a public key from the user's authorized keys by its index in the keys list.

Example:

```
soodar# show ip ssh pubkey-chain
List is empty
soodar# conf ter
soodar(config)# ip ssh pubkey-chain
soodar(conf-ssh-publickey)# username admin
soodar(conf-ssh-publickey-user)# key ssh-rsa
→AAAAB3NzaC1yc2EAAAADAQABAAQChX8nvRsv/nmZE8r+ljuVjiwe8riTt+kmSilS44/
→Wr+EFWbncx/E39QugQba+0I21/wn17bHbQitMMnXjINUITzqwTnnYQ
ekwSFjBuZKWKKe4i0fYoYH2cqySHiecGJHaRD40Jw/
→6+FTDK4c0PdBIg1Vd3hF8H+bCyberpEzaJKwN2WBV4Pp2QQSU4hcIag0CB/5uk2Nb08/Ewa/
→cVG3uPURzDWA2RRh5SI320clRyYDkmrcPv6zcZ81tFx1t6F12N0/U12n/
→XQw+5YEL8H1bGEeQVG+p4eHu0BjP4Ta1Pz75F10s/
→bylGQzTGlSrH4tAz7nj011XdAVAJ4ZuQ35KIwh0sVzEKVwZ9ZRFv0H4P0ijL59f/
→VRD878v7kVrRSKmkYZYUoJH4TBSkGEASGUXGYF+zzTI0RAa3+4j9yFaUMJJ1j10aMq+FshykuX+3DpBKYQ3of3KWNfLHRCGYao7Eh3QOCxUCN5DuAtYhAd/vzF3Dkyan06LnnbCYkg7SFzWE= temp@test
soodar# show ip ssh pubkey-chain
admin:
  1: W7tjsK1S4C+CfmfjJSQzjiRQHPnHNMhFjbmMyOE02wU temp@test (ssh-rsa)
soodar# show ip ssh pubkey-chain verbose
admin:
  1: AAAAB3NzaC1yc2EAAAADAQABAAQChX8nvRsv/nmZE8r+ljuVjiwe8riTt+kmSilS44/
→Wr+EFWbncx/E39QugQba+0I21/
→wn17bHbQitMMnXjINUITzqwTnnYQekwSFjBuZKWKKe4i0fYoYH2cqySHiecGJHaRD4
0Jw/6+FTDK4c0PdBIg1Vd3hF8H+bCyberpEzaJKwN2WBV4Pp2QQSU4hcIag0CB/5uk2Nb08/Ewa/
→cVG3uPURzDWA2RRh5SI320clRyYDkmrcPv6zcZ81tFx1t6F12N0/U12n/
→XQw+5YEL8H1bGEeQVG+p4eHu0BjP4Ta1P
z75F10s/bylGQzTGlSrH4tAz7nj011XdAVAJ4ZuQ35KIwh0sVzEKVwZ9ZRFv0H4P0ijL59f/
→VRD878v7kVrRSKmkYZYUoJH4TBSkGEASGUXGYF+zzTI0RAa3+4j9yFaUMJJ1j10aMq+FshykuX+3DpBKYQ3of3KWNfLHRC
GYao7Eh3QOCxUCN5DuAtYhAd/vzF3Dkyan06LnnbCYkg7SFzWE= temp@test (ssh-rsa)
```

## SSH Client

### ip ssh client

Enter SSH client known host management mode.

### known-host <A.B.C.D|X:X::X:X|HOST>

Add a server's public key(s) ( provided by its IP or hostname) to the known hosts' list of current users.

### no known-host <A.B.C.D|X:X::X:X|HOST>

Remove a server from the known hosts of the current user.

### show ip ssh client known-host <A.B.C.D|X:X::X:X|HOST>

Show public keys( if any) of a server stored in the known hosts' list.

Example:

```
soodar# show ip ssh client known-host 192.168.30.50
soodar# conf ter
soodar(config)# ip ssh client
soodar(conf-ssh-client)# known-host 192.168.30.50 ssh-rsa_
↪ AAAAAB3NzaC1yc2EAAAADAQABAAQGCwOU202nNjGXIN5VT1Q0j7+H9kQQ9FnE0sl9aPQb0g/
↪ SwlryZyuUmApUFFABL7MDNZTKzWd3BfYsOB
sX0sKOHigtZCPLbS93tvHAYlkeIcYDR9JJJEi4A67nN/
↪ zXSoT+Ew78iUADjWH6rQSy4dtg+SChFAj3Z9P7TQpK8zWJDLgA28d+zyYSwNd/
↪ MkF+EPmAH7mPoKkg2EGCpr889pR5mcBiXPVq69yUNFUG7U0D2aqDaGbaXk9TcfqCrktVmjGVF8rY91TaLMJBngVaYYsnT+xd
↪ jZhWtYdB4W/oFPAWa5YFqDRfu+VJdVnrGqIzr8GWR1POjAjwOsBcQk= HOST-KEY
soodar# show ip ssh client known-host 192.168.30.50
192.168.30.50 RSA SHA256:bYisVirAvDxXqwbmYIn7IEj6Grdkf6BeTYCJ7LS11s0 HOST-KEY
soodar# ssh test@192.168.30.50
test@192.168.30.50's password:
```

```
soodar# show ip ssh client known-host 192.168.30.39
soodar# ssh test@192.168.30.39
The authenticity of host '192.168.30.39 (192.168.30.39)' can't be established.
RSA key fingerprint is SHA256:LJ2gRSCd8Wh0CrcPU8s0LZJdrbff2QrGaJ5zBcZ2S4I.
Are you sure you want to continue connecting (yes/no/[fingerprint])? yes
Warning: Permanently added '192.168.30.39' (RSA) to the list of known hosts.
test@192.168.30.39's password:
soodar# show ip ssh client known-host 192.168.30.39
192.168.30.39 RSA SHA256:LJ2gRSCd8Wh0CrcPU8s0LZJdrbff2QrGaJ5zBcZ2S4I
```

## 1.2.2 Basic Config Commands

### hostname HOSTNAME

Set hostname of the router.

### log export removable-storage

Export system logs to connected USB removable storage. System logs contains FRR logs and syslogs

### log export ssh HOST USER PATH

Export system logs via SSH to HOST. System logs contains FRR logs and syslogs

### **log export ssh HOST USER PATH**

Export system logs via FTP to HOST. System logs contains FRR logs and syslogs

### **[no] ip host NAME A.B.C.D**

Add an entry to know hosts. The negation of this command cause the entry( if exists) be removed.

### **[no] ip name-server A.B.C.D**

Add or remove a Name server.

### **show clock [json]**

Show current date and time

Example:

```
soodar# show clock
      Local time: Thu 2020-09-24 10:15:37 +0330
      Universal time: Thu 2020-09-24 06:45:37 UTC
      RTC time: Thu 2020-09-24 06:45:37
      Time zone: Asia/Tehran (+0330, +0330)
System clock synchronized: yes
      NTP service: active
      RTC in local TZ: no
soodar(config)# do show clock json
{
  "timezone": "Asia/Tehran",
  "local_rtc": "no",
  "can_ntp": "yes",
  "ntp": "yes",
  "ntp_synchronized": "yes",
  "time_usec": "Thu 2020-09-24 10:15:37 +0330",
  "rtc_time_usec": "Thu 2020-09-24 06:45:37"
}
```

### **clock timezone TIMEZONE**

Set system timezone. TIMEZONE is timezone's long name based on IANA TZDatabase

Example:

### **show daemons status**

Show all daemons status on startup. Indicate whether they are enabled or disabled.

### **service password-encryption**

Encrypt password.

## 1.2.3 Sample Config File

Below is a sample configuration file .

```
!
hostname soodar
enable password admin
enable config password configadmin
!
log stdout
```

(continues on next page)

(continued from previous page)

```
!  
!
```

! and # are comment characters. If the first character of the word is one of the comment characters then from the rest of the line forward will be ignored as a comment.

```
enable password admin!password
```

If a comment character is not the first character of the word, it's a normal character. So in the above example ! will not be regarded as a comment and the password is set to admin!password.

## Terminal Mode Commands

### write terminal

Displays the current configuration to the vty interface.

### write file

Write current configuration to configuration file.

### configure [terminal]

Change to configuration mode. This command is the first step to configuration.

### list

List all available commands.

### show version

Show the current version of SoodarOS and its host information.

### show command history

Show entered commands. The history is kept between sessions and is not cleared until an explicit demand of removing history

### clear command history [(0-200)]

Clear history command and( if provided) keep the last N commands in history. If N is not provided or it is 0, all history is erased.

### show processes

Show current processes running on the router, their PIDs, statuses, and used memory.

Example:

```
soodar# show processes
  PID    LWP    PPID Status      Size Name
   1      1      0 S          22655 systemd
   2      2      0 S           0 kthreadd
   3      3      2 I           0 rcu_gp
   4      4      2 I           0 rcu_par_gp
   6      6      2 I           0 kworker/0:0H-kblockd
   8      8      2 I           0 mm_percpu_wq
   9      9      2 S           0 ksoftirqd/0
  10     10     2 I           0 rcu_preempt
  11     11     2 S           0 migration/0
  12     12     2 S           0 cpuhp/0
  13     13     2 S           0 cpuhp/1
```

(continues on next page)

(continued from previous page)

14	14	2 S	0 migration/1
15	15	2 S	0 ksoftirqd/1
17	17	2 I	0 kworker/1:0H-kblockd
18	18	2 S	0 kdevtmpfs
19	19	2 I	0 netns
20	20	2 S	0 rcu_tasks_kthre
21	21	2 S	0 kauditd
23	23	2 I	0 kworker/0:1-events
24	24	2 S	0 oom_reaper
25	25	2 I	0 writeback
26	26	2 S	0 kcompactd0
27	27	2 S	0 khugepaged
40	40	2 I	0 cryptd
59	59	2 I	0 kblockd
60	60	2 I	0 blkcg_punt_bio
61	61	2 I	0 tpm_dev_wq
62	62	2 I	0 ata_sff
63	63	2 I	0 md
64	64	2 S	0 watchdogd
65	65	2 S	0 kswapd0
67	67	2 I	0 acpi_thermal_pm
69	69	2 I	0 tpm-vtpm
70	70	2 I	0 nvme-wq
71	71	2 I	0 nvme-reset-wq
72	72	2 I	0 nvme-delete-wq
73	73	2 S	0 scsi_eh_0
74	74	2 I	0 scsi_tmf_0
75	75	2 S	0 scsi_eh_1
76	76	2 I	0 scsi_tmf_1
77	77	2 S	0 scsi_eh_2
78	78	2 I	0 scsi_tmf_2
79	79	2 S	0 scsi_eh_3
80	80	2 I	0 scsi_tmf_3
81	81	2 S	0 scsi_eh_4
82	82	2 I	0 scsi_tmf_4
83	83	2 S	0 scsi_eh_5
84	84	2 I	0 scsi_tmf_5
89	89	2 I	0 kworker/u4:6-events_unbound
91	91	2 I	0 kworker/0:1H-kblockd
92	92	2 I	0 kworker/1:2-rcu_gp
93	93	2 I	0 raid5wq
94	94	2 I	0 dm_bufio_cache
95	95	2 I	0 ipv6_addrconf
96	96	2 I	0 kworker/u5:0
101	101	2 S	0 jbd2/sda2-8
102	102	2 I	0 ext4-rsv-conver
103	103	2 I	0 kworker/1:1H-events_highpri
108	108	2 S	0 jbd2/sda4-8
109	109	2 I	0 ext4-rsv-conver
150	150	1 S	3299 systemd-udevd
179	179	2 S	0 scsi_eh_6
180	180	2 I	0 scsi_tmf_6

(continues on next page)

(continued from previous page)

181	181	2 S	0	scsi_eh_7
182	182	2 I	0	scsi_tmf_7
183	183	2 I	0	kworker/1:3-dm_bufio_cache
199	199	1 S	37847	rngd
199	212	1 S	37847	rngd
199	213	1 S	37847	rngd
307	307	1 S	3163	soosys
311	311	1 S	12305	systemd-journal
318	318	1 S	605	atd
320	320	1 S	730	crond
321	321	1 S	1082	dbus-daemon
332	332	1 S	3521	snmpd
334	334	1 S	2793	snmptrapd
335	335	1 S	1091	chronyd
340	340	1 R	21304346	vpp_main
340	359	1 S	21304346	eal-intr-thread
348	348	1 S	1520	systemd-logind
350	350	1 S	592	agetty
351	351	1 S	914	login
352	352	1 S	324366	charon-systemd
352	369	1 S	324366	charon-systemd
352	370	1 S	324366	charon-systemd
352	371	1 S	324366	charon-systemd
352	372	1 S	324366	charon-systemd
352	373	1 S	324366	charon-systemd
352	374	1 S	324366	charon-systemd
352	375	1 S	324366	charon-systemd
352	376	1 S	324366	charon-systemd
352	377	1 S	324366	charon-systemd
352	378	1 S	324366	charon-systemd
352	379	1 S	324366	charon-systemd
352	380	1 S	324366	charon-systemd
352	381	1 S	324366	charon-systemd
352	382	1 S	324366	charon-systemd
352	383	1 S	324366	charon-systemd
352	384	1 S	324366	charon-systemd
354	354	1 S	110108	f2b/server
354	361	1 S	110108	f2b/observer
354	364	1 S	110108	f2b/f.sshd
354	365	1 S	110108	f2b/a.sshd
354	6750	1 S	110108	f2b/observer
418	418	1 S	3963	watchfrr
433	433	1 S	106344	zebra
433	434	1 S	106344	RCU sweeper
433	435	1 S	106344	zebra_dplane
433	436	1 S	106344	zebra_opaque
433	440	1 S	106344	zebra_apic
438	438	1 S	2330	staticd
458	458	2 I	0	kworker/u4:0-events_unbound
657	657	1 S	1946	systemd
658	658	657 S	22868	(sd-pam)
663	663	351 R	11757	vttysh

(continues on next page)

(continued from previous page)

```

5763    5763        2 I                0 kworker/0:2-mm_percpu_wq
7634    7634       433 R              1092 ps

```

**show processes detailed process-id (0-1000000)**

Show details of a PID.

Example:

```

soodar# show processes detailed process-id 433
zebra
Process ID      : 433
Parent process ID : 1
Group ID       : 433
Status        : S
Session ID    : 433
User time     : 31
Kernel time   : 17
Priority      : 19
Virtual bytes  : 435585024
Resident pages : 4598
Resident limit : 18446744073709551615
Minor page faults : 851
Major page faults : 2
Threads       : 5
Allowed CPUs  : 0-1
CPU usage     : 0.0%
Memory usage  : 0.6%

```

**show processes memory**

Show data-plane's main heap usage, data-plane's stats heap usage, and processes' memory usage.

Example:

```

soodar# show processes memory
Dataplane memory heap:
-----
Thread 0 vpp_main
  base 0x7ffffb692a000, size 1g, locked, unmap-on-destroy, name 'main heap'
  page stats: page-size 4K, total 262144, mapped 24279, not-mapped 237865
  numa 0: 24279 pages, 94.84m bytes
  total: 1023.99M, used: 90.17M, free: 933.83M, trimmable: 933.81M

Dataplane stats heap:
-----
Stats segment
base 0x7ffffb0371000, size 31.99m, locked, name 'stat segment'
total: 31.99M, used: 758.05K, free: 31.26M, trimmable: 30.30M
free chunks 16 free fastbin blks 0
max total allocated 31.99M

System processes memory status:
-----

```

PID	Text	Data	RSS	Total	Name
-----	------	------	-----	-------	------

(continues on next page)



(continued from previous page)

1	0	90620	7460	22655	systemd
2	0	0	0	0	kthreadd
3	0	0	0	0	rcu_gp
4	0	0	0	0	rcu_par_gp
6	0	0	0	0	kworker/0:0H-kblockd
8	0	0	0	0	mm_percpu_wq
9	0	0	0	0	ksoftirqd/0
10	0	0	0	0	rcu_preempt
11	0	0	0	0	migration/0
12	0	0	0	0	cpuhp/0
13	0	0	0	0	cpuhp/1
14	0	0	0	0	migration/1
15	0	0	0	0	ksoftirqd/1
17	0	0	0	0	kworker/1:0H-kblockd
18	0	0	0	0	kdevtmpfs
19	0	0	0	0	netns
20	0	0	0	0	rcu_tasks_kthre
21	0	0	0	0	kauditd
23	0	0	0	0	kworker/0:1-events
24	0	0	0	0	oom_reaper
25	0	0	0	0	writeback
26	0	0	0	0	kcompactd0
27	0	0	0	0	khugepaged
40	0	0	0	0	cryptd
59	0	0	0	0	kblockd
60	0	0	0	0	blkcg_punt_bio
61	0	0	0	0	tpm_dev_wq
62	0	0	0	0	ata_sff
63	0	0	0	0	md
64	0	0	0	0	watchdogd
65	0	0	0	0	kswapd0
67	0	0	0	0	acpi_thermal_pm
69	0	0	0	0	tpm-tpm
70	0	0	0	0	nvme-wq
71	0	0	0	0	nvme-reset-wq
72	0	0	0	0	nvme-delete-wq
73	0	0	0	0	scsi_eh_0
74	0	0	0	0	scsi_tmf_0
75	0	0	0	0	scsi_eh_1
76	0	0	0	0	scsi_tmf_1
77	0	0	0	0	scsi_eh_2
78	0	0	0	0	scsi_tmf_2
79	0	0	0	0	scsi_eh_3
80	0	0	0	0	scsi_tmf_3
81	0	0	0	0	scsi_eh_4
82	0	0	0	0	scsi_tmf_4
83	0	0	0	0	scsi_eh_5
84	0	0	0	0	scsi_tmf_5
89	0	0	0	0	kworker/u4:6-events_unbound
91	0	0	0	0	kworker/0:1H-kblockd
92	0	0	0	0	kworker/1:2-rcu_gp
93	0	0	0	0	raid5wq

(continues on next page)

(continued from previous page)

94	0	0	0	0	dm_bufio_cache
95	0	0	0	0	ipv6_addrconf
96	0	0	0	0	kworker/u5:0
101	0	0	0	0	jbd2/sda2-8
102	0	0	0	0	ext4-rsv-conver
103	0	0	0	0	kworker/1:1H-events_highpri
108	0	0	0	0	jbd2/sda4-8
109	0	0	0	0	ext4-rsv-conver
150	0	13196	3960	3299	systemd-udev
179	0	0	0	0	scsi_eh_6
180	0	0	0	0	scsi_tmf_6
181	0	0	0	0	scsi_eh_7
182	0	0	0	0	scsi_tmf_7
183	0	0	0	0	kworker/1:3-events_power_efficient
199	0	151388	1028	37847	rngd
307	0	12652	5172	3163	soosys
311	0	49220	16556	12305	systemd-journal
318	0	2420	1628	605	atd
320	0	2920	1844	730	crond
321	0	4328	3448	1082	dbus-daemon
332	0	14084	11056	3521	snmpd
334	0	11172	6800	2793	snmptrapd
335	0	4364	2400	1091	chronyd
340	0	85217384	135968	21304346	vpp_main
348	0	6080	4348	1520	systemd-logind
350	0	2368	1812	592	agetty
351	0	3656	3096	914	login
352	0	1297464	12912	324366	charon-systemd
354	0	440432	21636	110108	f2b/server
418	0	16364	11720	4091	watchfrr
433	0	425376	18492	106344	zebra
438	0	9320	4756	2330	staticd
458	0	0	0	0	kworker/u4:0-events_unbound
657	0	7784	6296	1946	systemd
658	0	91472	2068	22868	(sd-pam)
663	0	48612	43816	12153	vtys
5763	0	0	0	0	kworker/0:2-mm_percpu_wq
8135	84	4283	2472	1092	ps

**show hardware {cpu | disk | memory}**

Show information about the router's hardware.

Example:

```
n1# show hardware cpu disk memory
CPU information
-----
Architecture      : X86_64
Name               : Intel(R) Celeron(R) CPU J1900 @ 1.99GHz
Physical cores    : 4
Total cores       : 4
Max Frequency     : 2415.70Mhz
```

(continues on next page)

(continued from previous page)

```

Min Frequency      : 1332.80Mhz
Current Frequency  : 1876.04Mhz
NUMA Nodes        : 1
Total CPU Usage    : 51.7%
Per Core Information:
  Core 0:
    Type           : Physical
    Physical Core: 0
    NUMA Node      : 0
    Usage          : 0.0%
  Core 1:
    Type           : Physical
    Physical Core: 1
    NUMA Node      : 0
    Usage          : 100.0%
  Core 2:
    Type           : Physical
    Physical Core: 2
    NUMA Node      : 0
    Usage          : 68.8%
  Core 3:
    Type           : Physical
    Physical Core: 3
    NUMA Node      : 0
    Usage          : 37.9%

Memory information
-----
Total           : 3.74G
Available       : 1.33G
Used            : 2.21G
Percentage      : 64.6%

NUMA 0 Total    : 3.65G
NUMA 0 Available : 1.31G
NUMA 0 Used     : 2.35G
NUMA 0 Percentage: 64.2%

Partitions and Usage
-----
Device: /dev/root
Mountpoint      : /
File system type: ext4
Total Size      : 3.44G
Used            : 1.11G
Free            : 2.13G
Percentage      : 34.2%
Device: /dev/sda4
Mountpoint      : /data
File system type: ext4
Total Size      : 21.96G

```

(continues on next page)

(continued from previous page)

```

Used          : 38.30M
Free          : 20.79G
Percentage    : 0.2%
Device: /dev/sda1
Mountpoint    : /boot/efi
File system type: vfat
Total Size    : 15.95M
Used          : 856064
Free          : 15.13M
Percentage    : 5.1%

```

**show memory control-plane**

Show information on how much memory is used by control-plane's processes:

Example:

```

soodar# show memory control-plane
top - 11:26:57 up 2:31, 0 users, load average: 1.64, 0.76, 0.56
Tasks: 13 total, 0 running, 13 sleeping, 0 stopped, 0 zombie
%Cpu(s): 3.7 us, 1.2 sy, 0.1 ni, 91.4 id, 3.1 wa, 0.0 hi, 0.5 si, 0.0 st
KiB Mem : 14322432 total, 5440116 free, 4352300 used, 4530016 buff/cache
KiB Swap: 2097148 total, 2097148 free, 0 used. 9377520 avail Mem

PID USER      PR  NI   VIRT   RES   SHR  S  %CPU  %MEM     TIME+  COMMAND
164 frr        20   0  311388  7792  2224  S   0.0   0.1   0:00.00  bgpd
297 frr        20   0   85136  5416  3136  S   0.0   0.0   0:00.00  eigrpd
288 frr        20   0   85556  5960  3436  S   0.0   0.0   0:00.00  isisd
273 frr        20   0   85736  5824  3384  S   0.0   0.0   0:00.00  ldpd
217 frr        20   0   84248  5072  4152  S   0.0   0.0   0:00.00  ldpd
216 frr        20   0   84096  5052  4140  S   0.0   0.0   0:00.00  ldpd
266 frr        20   0   85432  5628  3172  S   0.0   0.0   0:00.00  ospf6d
192 frr        20   0   86036  6456  3740  S   0.0   0.0   0:00.03  ospfd
176 frr        20   0   85124  5684  3416  S   0.0   0.0   0:00.00  ripd
184 frr        20   0   84812  5488  3372  S   0.0   0.0   0:00.00  ripngd
281 frr        20   0   84628  4028  2168  S   0.0   0.0   0:00.00  staticd
100 root       20   0   83924  3676  2432  S   0.0   0.0   0:00.04  watchfrr
154 frr        20   0 2689096 27420  5592  S   0.0   0.2   0:00.02  zebra

```

**show memory control-plane details**

Show information on how much memory is used by control-plane's processes in details

Example:

```

soodar# show memory control-plane details
System allocator statistics:
Total heap allocated: 1584 KiB
Holding block headers: 0 bytes
Used small blocks: 0 bytes
Used ordinary blocks: 1484 KiB
Free small blocks: 2096 bytes
Free ordinary blocks: 100 KiB
Ordinary blocks: 2
Small blocks: 60

```

(continues on next page)

(continued from previous page)

```

Holding blocks:          0
(see system documentation for 'mallinfo' for meaning)
--- qmem libfrr ---
Buffer                   :          3          24          72
Buffer data              :          1       4120       4120
Host config              :          3 (variably sized)    72
Command Tokens           :       3427          72     247160
Command Token Text       :       2555 (variably sized)   83720
Command Token Help       :       2555 (variably sized)   61720
Command Argument         :          2 (variably sized)    48
Command Argument Name    :       641 (variably sized)   15672
[...]
--- qmem Label Manager ---
--- qmem zebra ---
ZEBRA VRF                :          1          912          920
Route Entry              :         11          80          968
Static route             :          1         192          200
RIB destination          :          8          48          448
RIB table info           :          4          16           96
Nexthop tracking object   :          1         200          200
Zebra Name Space         :          1         312          312
--- qmem Table Manager ---

```

Below these statistics, statistics on individual memory allocation types in SoodarOS (so-called *MTYPES*) is printed: \* the first column of numbers is the current count of allocations made for

the type (the number decreases when items are freed.)

- the second column is the size of each item. This is only available if allocations on a type are always made with the same size.
- the third column is the total amount of memory allocated for the particular type, including padding applied by malloc. This means that the number may be larger than the first column multiplied by the second. Overhead incurred by malloc's bookkeeping is not included in this, and the column may be missing if system support is not available.

### find COMMAND...

This command performs a simple substring search across all defined commands in all modes. As an example, suppose you're in enable mode and can't remember where the command to set router-id is:

```
Soodar# find router-id
(config) router-id A.B.C.D [vrf NAME]
```

### show thread cpu control-plane [details [r|w|t|e|x]]

This command displays control-plane run statistics for all the different event types. If no options is specified all different run types are displayed together. Additionally you can ask to look at (r)ead, (w)rite, (t)imer, (e)vent and e(x)ecute thread event types.

## Pipe Actions

CLI supports optional modifiers at the end of commands that perform postprocessing on command output or modify the action of commands. These do not show up in the ? or TAB suggestion lists.

### ... | **include REGEX**

Filters the output of the preceding command, including only lines which match the POSIX Extended Regular Expression REGEX. Do not put the regex in quotes.

Examples:

```
Soodar# show ip bgp sum json | include remoteAs
  "remoteAs":0,
  "remoteAs":455,
  "remoteAs":99,
```

```
Soodar# show run | include neigh.*[0-9]{2}\.0\.[2-4]\.[0-9]*
neighbor 10.0.2.106 remote-as 99
neighbor 10.0.2.107 remote-as 99
neighbor 10.0.2.108 remote-as 99
neighbor 10.0.2.109 remote-as 99
neighbor 10.0.2.110 remote-as 99
neighbor 10.0.3.111 remote-as 111
```

### ... | **exclude REGEX**

Filters the output of the preceding command, including only lines which **don't** match the POSIX Extended Regular Expression REGEX. Do not put the regex in quotes.

### ... | **section REGEX**

Filters the output of the preceding command, including only sections which match the POSIX Extended Regular Expression REGEX. Do not put the regex in quotes.

Example:

```
n2# show running-config | section interface\swireguard[1-3]0
interface wireguard10
  bridge-group 100 split-horizon group 0
  wireguard source 200.2.3.2
  wireguard private-key n2key1
  wireguard port 51820
  wireguard peer n3
    public-key D3309A5B6BF9FEC26710852AB0D6F6E5783F9343478933788D6C0BBB204FED4A
    endpoint 200.2.3.3 port 51820
    allowed-ip 200.4.4.4/32
  no shutdown
  ip address 10.200.200.1/32
interface wireguard20
  wireguard source 222.2.3.2
  wireguard private-key n2key2
  wireguard port 51821
  wireguard peer n3
    public-key 3B73F9AFBBD9C7C14C4F1108381F704050137990418C500B1F8465A13EDD637
    allowed-ip 10.0.1.2/32
    allowed-ip 10.0.3.2/32
    allowed-ip 222.4.4.4/32
```

(continues on next page)

(continued from previous page)

```
no shutdown
ip address 10.200.200.2/32
interface wireguard30
wireguard source 222.2.3.2
wireguard private-key n2key3
wireguard port 51822
wireguard peer n3
  public-key 2F12ACA8B029112BA405286239D38CD43210AA713C7D7E73362C28A25AA04439
  allowed-ip 203.4.4.4/32
no shutdown
ip address 10.200.200.3/32
```

**... | section-exclude REGEX**

Filters the output of the preceding command, including only sections which **don't** match the POSIX Extended Regular Expression REGEX. Do not put the regex in quotes.

Example:

```
soodar# show running-config | section-exclude interface
Building configuration...

Current configuration:
!
hostname soodar
no ipv6 forwarding
no zebra nexthop kernel enable
security passwords min-length 8
log syslog errors
log monitor
no banner motd
!
ip name-server 4.2.2.4
ntp server ir.pool.ntp.org iburst burst
!
ip route 0.0.0.0/0 192.168.1.1
line vty
!
end
```

## 1.2.4 Filtering

FRR provides many very flexible filtering features. Filtering is used for both input and output of the routing information. Once filtering is defined, it can be applied in any direction.

### IP Prefix List

*ip prefix-list* provides the most powerful prefix based filtering mechanism. In addition to *access-list* functionality, *ip prefix-list* has prefix length range specification and sequential number specification. You can add or delete prefix based filters to arbitrary points of prefix-list using sequential number specification.

If no *ip prefix-list* is specified, it acts as permit. If *ip prefix-list* is defined, and no match is found, default deny is applied.

**ip prefix-list NAME (permit|deny) PREFIX [le LEN] [ge LEN]**

**ip prefix-list NAME seq NUMBER (permit|deny) PREFIX [le LEN] [ge LEN]**

You can create *ip prefix-list* using above commands.

#### seq

*seq number* can be set either automatically or manually. In the case that sequential numbers are set manually, the user may pick any number less than 4294967295. In the case that sequential number are set automatically, the sequential number will increase by a unit of five (5) per list. If a list with no specified sequential number is created after a list with a specified sequential number, the list will automatically pick the next multiple of five (5) as the list number. For example, if a list with number 2 already exists and a new list with no specified number is created, the next list will be numbered 5. If lists 2 and 7 already exist and a new list with no specified number is created, the new list will be numbered 10.

#### le

Specifies prefix length. The prefix list will be applied if the prefix length is less than or equal to the *le* prefix length.

#### ge

Specifies prefix length. The prefix list will be applied if the prefix length is greater than or equal to the *ge* prefix length.

Less than or equal to prefix numbers and greater than or equal to prefix numbers can be used together. The order of the *le* and *ge* commands does not matter.

If a prefix list with a different sequential number but with the exact same rules as a previous list is created, an error will result. However, in the case that the sequential number and the rules are exactly similar, no error will result.

If a list with the same sequential number as a previous list is created, the new list will overwrite the old list.

Matching of IP Prefix is performed from the smaller sequential number to the larger. The matching will stop once any rule has been applied.

In the case of no *le* or *ge* command, the prefix length must match exactly the length specified in the prefix list.

**no ip prefix-list NAME**



## ip prefix-list description

**ip prefix-list NAME description DESC**

Descriptions may be added to prefix lists. This command adds a description to the prefix list.

**no ip prefix-list NAME description [DESC]**

Deletes the description from a prefix list. It is possible to use the command without the full description.

## ip prefix-list sequential number control

**ip prefix-list sequence-number**

With this command, the IP prefix list sequential number is displayed. This is the default behavior.

**no ip prefix-list sequence-number**

With this command, the IP prefix list sequential number is not displayed.

## Showing ip prefix-list

**show ip prefix-list**

Display all IP prefix lists.

**show ip prefix-list NAME**

Show IP prefix list can be used with a prefix list name.

**show ip prefix-list NAME seq NUM**

Show IP prefix list can be used with a prefix list name and sequential number.

**show ip prefix-list NAME A.B.C.D/M**

If the command longer is used, all prefix lists with prefix lengths equal to or longer than the specified length will be displayed. If the command first match is used, the first prefix length match will be displayed.

**show ip prefix-list NAME A.B.C.D/M longer**

**show ip prefix-list NAME A.B.C.D/M first-match**

**show ip prefix-list summary**

**show ip prefix-list summary NAME**

**show ip prefix-list detail**

**show ip prefix-list detail NAME**

## Clear counter of ip prefix-list

**clear ip prefix-list [NAME [A.B.C.D/M]]**

Clears the counters of all IP prefix lists. Clear IP Prefix List can be used with a specified NAME or NAME and prefix.

## 1.2.5 Route Maps

Route maps provide a means to both filter and/or apply actions to route, hence allowing policy to be applied to routes.

For a route reflector to apply a route-map to reflected routes, be sure to include `bgp route-reflector allow-outbound-policy` in `router bgp` mode.

Route maps are an ordered list of route map entries. Each entry may specify up to four distinct sets of clauses:

### Matching Conditions

A route-map entry may, optionally, specify one or more conditions which must be matched if the entry is to be considered further, as governed by the Match Policy. If a route-map entry does not explicitly specify any matching conditions, then it always matches.

### Set Actions

A route-map entry may, optionally, specify one or more Set Actions to set or modify attributes of the route.

### Matching Policy

This specifies the policy implied if the *Matching Conditions* are met or not met, and which actions of the route-map are to be taken, if any. The two possibilities are:

- *permit*: If the entry matches, then carry out the *Set Actions*. Then finish processing the route-map, permitting the route, unless an *Exit Policy* action indicates otherwise.
- *deny*: If the entry matches, then finish processing the route-map and deny the route (return *deny*).

The *Matching Policy* is specified as part of the command which defines the ordered entry in the route-map. See below.

### Call Action

Call to another route-map, after any *Set Actions* have been carried out. If the route-map called returns *deny* then processing of the route-map finishes and the route is denied, regardless of the *Matching Policy* or the *Exit Policy*. If the called route-map returns *permit*, then *Matching Policy* and *Exit Policy* govern further behaviour, as normal.

### Exit Policy

An entry may, optionally, specify an alternative *Exit Policy* to take if the entry matched, rather than the normal policy of exiting the route-map and permitting the route. The two possibilities are:

- *next*: Continue on with processing of the route-map entries.
- *goto N*: Jump ahead to the first route-map entry whose order in the route-map is  $\geq N$ . Jumping to a previous entry is not permitted.

The default action of a route-map, if no entries match, is to deny. I.e. a route-map essentially has as its last entry an empty *deny* entry, which matches all routes. To change this behaviour, one must specify an empty *permit* entry as the last entry in the route-map.

To summarise the above:

	Match	No Match
Permit	action	cont
Deny	deny	cont

### action

- Apply *set* statements
- If *call* is present, call given route-map. If that returns a *deny*, finish processing and return *deny*.
- If *Exit Policy* is *next*, goto next route-map entry
- If *Exit Policy* is *goto*, goto first entry whose order in the list is  $\geq$  the given order.

- Finish processing the route-map and permit the route.

**deny**

The route is denied by the route-map (return deny).

**cont**

goto next route-map entry

**show route-map [WORD]**

Display data about each daemons knowledge of individual route-maps. If WORD is supplied narrow choice to that particular route-map.

**clear route-map counter [WORD]**

Clear counters that are being stored about the route-map utilization so that subsequent show commands will indicate since the last clear. If WORD is specified clear just that particular route-map's counters.

**Route Map Command****route-map ROUTE-MAP-NAME (permit|deny) ORDER**

Configure the *order*'th entry in *route-map-name* with Match Policy of either *permit* or *deny*.

**Route Map Match Command****match ip address ACCESS\_LIST**

Matches the specified *access\_list*

**match ip address prefix-list PREFIX\_LIST**

Matches the specified *PREFIX\_LIST*

**match ip address prefix-len 0-32**

Matches the specified *prefix-len*. This is a Zebra specific command.

**match ipv6 address ACCESS\_LIST**

Matches the specified *access\_list*

**match ipv6 address prefix-list PREFIX\_LIST**

Matches the specified *PREFIX\_LIST*

**match ipv6 address prefix-len 0-128**

Matches the specified *prefix-len*. This is a Zebra specific command.

**match ip next-hop address IPV4\_ADDR**

This is a BGP specific match command. Matches the specified *ipv4\_addr*.

**match ipv6 next-hop IPV6\_ADDR**

This is a BGP specific match command. Matches the specified *ipv6\_addr*.

**match as-path AS\_PATH**

Matches the specified *as\_path*.

**match metric METRIC**

Matches the specified *metric*.

**match tag TAG**

Matches the specified tag value associated with the route. This tag value can be in the range of (1-4294967295).

**match local-preference METRIC**

Matches the specified *local-preference*.

**match community COMMUNITY\_LIST**

Matches the specified *community\_list*

**match peer IPV4\_ADDR**

This is a BGP specific match command. Matches the peer ip address if the neighbor was specified in this manner.

**match peer IPV6\_ADDR**

This is a BGP specific match command. Matches the peer ipv6 address if the neighbor was specified in this manner.

**match peer INTERFACE\_NAME**

This is a BGP specific match command. Matches the peer interface name specified if the neighbor was specified in this manner.

**match source-protocol PROTOCOL\_NAME**

This is a ZEBRA specific match command. Matches the originating protocol specified.

**match source-instance NUMBER**

This is a ZEBRA specific match command. The number is a range from (0-255). Matches the originating protocols instance specified.

## Route Map Set Command

**set tag TAG**

Set a tag on the matched route. This tag value can be from (1-4294967295). Additionally if you have compiled with the `--enable-realms` configure option. Tag values from (1-255) are sent to the Linux kernel as a realm value. Then route policy can be applied. See the tc man page.

**set ip next-hop IPV4\_ADDRESS**

Set the BGP nexthop address to the specified IPV4\_ADDRESS. For both incoming and outgoing route-maps.

**set ip next-hop peer-address**

Set the BGP nexthop address to the address of the peer. For an incoming route-map this means the ip address of our peer is used. For an outgoing route-map this means the ip address of our self is used to establish the peering with our neighbor.

**set ip next-hop unchanged**

Set the route-map as unchanged. Pass the route-map through without changing it's value.

**set ipv6 next-hop peer-address**

Set the BGP nexthop address to the address of the peer. For an incoming route-map this means the ipv6 address of our peer is used. For an outgoing route-map this means the ip address of our self is used to establish the peering with our neighbor.

**set ipv6 next-hop prefer-global**

For Incoming and Import Route-maps if we receive a v6 global and v6 LL address for the route, then prefer to use the global address as the nexthop.

**set ipv6 next-hop global IPV6\_ADDRESS**

Set the next-hop to the specified IPV6\_ADDRESS for both incoming and outgoing route-maps.

**set local-preference LOCAL\_PREF**

Set the BGP local preference to *local\_pref*.

**set local-preference +LOCAL\_PREF**

Add the BGP local preference to an existing *local\_pref*.

**set local-preference -LOCAL\_PREF**

Subtract the BGP local preference from an existing *local\_pref*.

**[no] set distance DISTANCE**

Set the Administrative distance to DISTANCE to use for the route. This is only locally significant and will not be dispersed to peers.

**set weight WEIGHT**

Set the route's weight.

**[no] set metric <[+|-] (1-4294967295) |rtt|+rtt|-rtt>**

Set the BGP attribute MED to a specific value. Use +/- to add or subtract the specified value to/from the MED. Use *rtt* to set the MED to the round trip time or *+rtt/-rtt* to add/subtract the round trip time to/from the MED.

**set as-path prepend AS\_PATH**

Set the BGP AS path to prepend.

**set community COMMUNITY**

Set the BGP community attribute.

**set ipv6 next-hop local IPV6\_ADDRESS**

Set the BGP-4+ link local IPv6 nexthop address.

**set origin ORIGIN <egp|igp|incomplete>**

Set BGP route origin.

**Route Map Call Command****call NAME**

Call route-map *name*. If it returns deny, deny the route and finish processing the route-map.

**Route Map Exit Action Command****on-match next****continue**

Proceed on to the next entry in the route-map.

**on-match goto N****continue N**

Proceed processing the route-map at the first entry whose order is  $\geq N$

## Route Map Optimization Command

### **route-map optimization**

Enable route-map processing optimization. The optimization is enabled by default. Instead of sequentially passing through all the route-map indexes until a match is found, the search for the best-match index will be based on a look-up in a prefix-tree. A per-route-map prefix-tree will be constructed for this purpose. The prefix-tree will compose of all the prefixes in all the prefix-lists that are included in the match rule of all the sequences of a route-map.

### **no route-map optimization**

Disable the route-map processing optimization.

## Route Map Examples

A simple example of a route-map:

```
route-map test permit 10
match ip address 10
set local-preference 200
```

This means that if a route matches ip access-list number 10 it's local-preference value is set to 200.

See *Miscellaneous Configuration Examples* for examples of more sophisticated usage of route-maps, including of the call action.

## 1.2.6 System

### System Logging

SoodarOS uses systemd-journald as the central logging solution.

#### **[no] debug service snmp**

Enable logging for SNMP service. All SNMP logs appear in journald.

#### **[no] debug service mender**

Enable logging for mender update service. All mender logs appear in journald.

#### **[no] debug service ntpd**

Enable logging for NTP service. All NTP logs appear in journald.

#### **[no] debug service dhcp4**

Enable logging for DHCP4 server service. All logs appear in journald.

#### **[no] debug dplane fib**

Enable data plane( VPP) FIB logs.

#### **[no] debug dplane ipsec**

Enable data plane( VPP) IPSec logs.

#### **log rotate max-file-size SIZE**

set SIZE as the limit of how sizeable individual journal files may grow at most. When a limit is reached, it rotates to the next journal file.

#### **log rotate max-files (1-1000)**

control how many individual journal files to keep at most. Default is 100.

**log rotate max-use SIZE**

Control how much disk space the journal may use up at most. The SIZE is capped at 4G. After reaching the limit, it starts removing elder journal files.

**[no] log rotate max-file-life (1-1000)**

The maximum time( in days) to store entries in a single journal file before rotating to the next one.

**[no] log rotate max-retention (1-1000)**

The maximum time( in days) to store journal entries. This controls whether journal files containing entries older than the specified period are deleted.

**[no] log file [LEVEL]**

If you want to enable log into a file, please enter the command as in this example:

```
log file informational
```

If the optional second argument specifying the logging level is not present, the default logging level (typically debugging, but can be changed using the deprecated `log trap` command) is used. The `no` form of the command disables logging to a file.

**[no] log syslog [LEVEL]**

Enable logging output to syslog. If the optional second argument specifying the logging level is not present, the default logging level (typically debugging, but can be changed using the deprecated `log trap` command) is used. The `no` form of the command disables logging to syslog. Default log level for syslog is set to error level.

**[no] log syslog [A.B.C.D|HOST] tcp [tls [skip-host-verify]] [port (100-65535)]**

Define a remote host to send syslogs. Make sure that `log syslog` is enabled to make this command work. The default port is 514. Users can enable TLS connection. By adding `skip-host-verify` option, the remote hostname is not checked against provided certificate CN/SAN.

Example:

```
soodar(config)# ip host logServer 1.1.1.1
soodar(config)# log syslog logServer tcp tls
```

**[no] log syslog HOST loki [skip-host-verify] [port (100-65535)]**

Define a remote host to send syslogs. Make sure that `log syslog` is enabled to make this command work. The default port is 3000. By adding the `skip-host-verify` option, the remote hostname is not checked against the provided certificate CN/SAN in the HTTPS connection.

---

**Note:** Loki connection uses `http` or `https` protocols to communicate. User **must** provide the `http` or `https` in address.

---



---

**Note:** Port is a different option. User **must not** provide a port in an address like `http://temp.ir:3100`. It's wrong!

---

Example:

```
soodar(config)# log syslog https://192.168.1.1 loki skip-host-verify port_
↪3100
```

**[no] log monitor [LEVEL]**

Enable logging output to terminal shell. By default, monitor logging is enabled at the informational level, but this command can be used to change the monitor logging level. If the optional second argument specifying the logging level is not present, the default logging level (typically informational) is used. The `no` form of the command disables logging to terminal monitors.

**[no] log facility [FACILITY]**

This command changes the facility used in syslog messages. The default facility is `daemon`. The `no` form of the command resets the facility to the default `daemon` facility.

**[no] log record-priority**

To include the severity in all messages logged to a file. Use the `log record-priority` global configuration command. To disable this option, use the `no` form of the command. By default, the severity level is not included in logged messages.

**[no] log timestamp precision [(0-6)]**

This command sets the precision of log message timestamps to the given number of digits after the decimal point. Currently, the value must be 0 to 6 (i.e., the maximum precision is microseconds). To restore the default behavior (1-second accuracy), use the `no` form of the command, or set the precision explicitly to 0.

```
log timestamp precision 3
```

In this example, the precision is set to provide timestamps with millisecond accuracy.

**[no] log commands**

This command enables the logging of all commands typed by a user to all enabled log destinations.

**show log all [follow]**

Show all journals logs. If the `follow` mode is enabled, it follows the updates.

**show log mender [follow]**

Show mender update service logs. If the `follow` mode is enabled, it follows the updates.

**show log ssh [follow]**

Show SSH service logs. If the `follow` mode is enabled, it follows the updates.

**show log soolog [follow]**

Show Soodar service logs. We are using *vector* for logging. If the `follow` mode is enabled, it follows the updates.

**show log snmpd [follow]**

Show SNMP service logs. If the `follow` mode is enabled, it follows the updates.

**show log ntpd [follow]**

Show NTP service logs. If the `follow` mode is enabled, it follows the updates.

**show log vpp [follow]**

Show VPP service( data plane) logs. If the `follow` mode is enabled, it follows the updates.

**show log frr [follow]**

Show FRR service( control plane) logs. If the `follow` mode is enabled, it follows the updates.

**show log ipsec [follow]**

Show IPSec service logs. If the `follow` mode is enabled, it follows the updates.

**show log kernel [follow]**

Show kernel and boot logs. If the `follow` mode is enabled, it follows the updates.



**clear log [syslog]**

Clear all generated logs. Using the `syslog` keyword makes the journald logs vacuumed; otherwise, the log file is truncated.

**System update**

SoodarOS uses `melder` as its system update solution. It supports both online and offline updates, and in case of failure, it can roll back to the previous version

**Online update**

Update system from a server. It is disabled by default. When an online update is enabled, the system automatically checks the server for available updates and install if any is present.

**Configuration****system update enable**

Enable online update

**no system update enable**

Disable online update

**system update server-url WORD**

Set update server's URL

---

**Note:** Update server address, should be a URL, and an IP address can't be set

---

**system update update-poll-interval (5-2147483647)**

Check for update interval in seconds

**system update inventory-poll-interval (5-2147483647)**

Send system inventory in intervals. Unit is in seconds

Example:

```
soodar(config)# system update enable
soodar(config)# system update server-url https://update.soodar.ir
soodar(config)# system update update-poll-interval 300
soodar(config)# system update inventory-poll-interval 400
```

**Offline update**

Update system from removable storage. The procedure to offline update is simple. One need to:

1. Install an update
2. Reboot
3. Commit the update( to make it persistent) or rollback the update( in case of failure. Reboot without a commit to rollback)

**Note:** To use offline update, the online update should be disabled

---

## Configuration

### system update offline list

List available updates on removable storage

Example:

```
n1(config)# system update offline list
 1 rls-20
 2 rls-21
 3 rls-21.1
```

### system update offline install ARTIFACT

Install update from removable storage. ARTIFACT is the relative path of update file from removable storage root, without .mender postfix

### system update offline commit

Commit latest installed update.

**Warning:** During the system's booting, no removable storage should be plugged into the router device, or the boot fails.

## System backup and restore

The router is equipped with a set of backup/restore tools. Currently, only *startup-config* could be backed up. The backup files could be stored in three ways:

1. To remote host and via SSH
2. To local storage
3. To removable storage

## Backup and restore via SSH

### Commands

#### system config backup ssh HOST USER PATH

Backup current startup-config to a remote host. HOST is the IP address or hostname of the desired destination USER is a remote host user that SSH tunnel is made to. And PATH is the address to save.

Examples:

```
soodar(config)# ip host bckup-server 192.168.1.123
soodar(config)# system config backup ssh bckup-server admin ~/backups/n1-edge
soodar(config)# system config backup ssh 10.12.12.1 sysadmin /var/router-backups/
↪test_bkp
```

**system config backup list ssh HOST USER PATH**

List available backup files on remote host. PATH is the remote destination *directory* that backups are stored

Example:

```
soodar(config)# system config backup list ssh bckup-server admin ~/backups
```

Tags in provided remote path:

```
 1  -rw-r--r-- 1 admin admin    0 Mar 17 10:33 n1-edge
 1  -rw-r--r-- 1 admin admin    0 Mar 16 19:52 n3
```

**system config restore ssh HOST USER PATH**

Example:

```
soodar(config)# system config backup restore ssh 10.12.12.1 sysadmin /var/router-
↪backups/test_bkp
```

**Backup and restore to and from removable storage****Commands****system config backup removable-storage NAME**

Backup current startup config to the removable storage. NAME is desired backup's name.

Examples:

```
soodar(config)# system config backup removable-storage before-a-big-change
```

**system config backup list removable-storage**

List available backup files on removable storage.

Example:

```
soodar(config)# system config backup list removable-storage
```

Tags in provided remote path:

```
 1  -rw-r--r-- 1 admin admin    0 Mar 17 10:51 before-a-big-change
```

**system config restore removable-storage NAME****Backup and restore to and from local****Commands****system config backup local NAME**

Backup current startup config to the local storage. NAME is desired backup's name.

Examples:

```
soodar(config)# system config backup local before-a-big-change
```

### **system config backup list local**

List available backup files on local storage.

Example:

```
soodar(config)# system config backup list local

Tags in provided remote path:
 1  -rw-r--r-- 1 admin admin   0 Mar 17 10:51 before-a-big-change
```

### **system config restore local NAME**

## Prometheus Monitoring

SoodarOS supports both SNMP and Prometheus for monitoring purposes. Users can enable Prometheus monitoring by running *soomon* service on the router. After running and enabling *soomon* service, the router can provide metrics on port 9200.

### **system service enable soomon**

Start *soomon* service to provide Prometheus monitoring.

---

**Note:** Currently, *soomon* only works on port 9200. This behavior could change in the future.

---

## System Services

Services are running in the background for accomplishing tasks. These services include:

- NTP: Network Time Protocol service.
- Mender: System update service.
- Soolog: Remote and local syslog service.
- SNMPD: SNMP Services
- VPP: Router service. Restarting this service is like restarting the router.
- soomon: Soodar Prometheus monitoring service.

### **show system service status SERVICE**

Show service status based on the output of `systemd`

### **system service restart SERVICE**

Restart a service. If service is not running, starts the service.

---

**Note:** An explicitly disabled service can not be restarted( for example, when a user has set `no ntp` command, one can not restart the NTP service).

---

## System Security

The admin can set the maximum TCP SYN limit to protect the system from SYN flood attacks.

### **tcp syn-flood limit (1-4294967295)**

Set TCP SYN limit. The default limit is 256.

URPF (Unicast Reverse-Path Forwarding) is a technique to help prevent IP Address spoofing by restricting the incoming packet's source address to those that the router has a route to. Failed packets are discarded.

URPF has two modes of operation:

- **Strict:** Every ingress packet's source is looked up in the FIB; if there's a route to source address but the incoming interface is not the output interface of the path, the packet check fails.
- **Loose:** Every ingress packet's source is looked up in the FIB; if there's no route to source address by any interface, the packet is discarded.

### **ip verify unicast source reachable-via [rx | any]**

Enable URPF on an interface. `rx` keyword set URPF in strict mode. The default mode is `any` ( loose mode).

## 1.2.7 SNMP

SNMP is a widely implemented feature for collecting network information from the router and/or host. FRR itself does not support SNMP agent (server daemon) functionality but is able to connect to an SNMP agent using the AgentX protocol (RFC 2741) and make the routing protocol MIBs available through it.

### **agentx**

Start SNMP Daemon and AgentX on the system

### **no agentx**

Stop SNMP Daemon and AgentX on the system

## SNMP Users

To access the SNMP MIBs, one or more users should be available. Currently, only SNMPv3 is supported.

### **snmp-server user USER auth <md5|sha> PASSWORD [priv des56 PRIV]**

Create a user named USER with authNoPriv security level and as ROUser. The user provides the authentication protocol and password. If *priv* is provided, a user named USER with authPriv security level as a ROUser is created.

---

**Note:** Password length can't be lesser than 8 characters.

---

Example:

```
soodar(config)# snmp-server user normal-user auth sha 12345678
soodar(config)# snmp-server user priv-user auth sha 12345678 priv des56 87654321
```

## 1.2.8 NTP

Network Time Protocol (NTP) is a well-known, widely used protocol to synchronize the time of the device over the internet. Using *chrony*, SoodarOS can be an NTP client supporting Version 3 and Version 4 of the NTP protocol

### Setting up NTP

Setting up an NTP client is just as simple as providing one( or more) NTP servers and giving needed options.

#### **ntp server SERVER [OPTIONS]**

Specifies an NTP server that can be used as a time source. Available options are:

- **burst:**  
With this option, the client will shorten the interval between up to four requests to 2 seconds or less when it cannot get a good measurement from the server.
- **iburst:**  
With this option, the interval between the first four requests sent to the server will be 2 seconds or less instead of the interval specified by the `minpoll` option.
- **key (1-65535):**  
The key option specifies which key (with an ID in the range 1 through 65535) should client use to authenticate requests sent to the server and verify its responses. The server must have the same key for this number configured, otherwise no relationship between the computers will be possible.
- **maxpoll (-6-24):**  
This option specifies the maximum interval between requests sent to the server as a power of 2 in seconds. For example, `maxpoll 9` indicates that the polling interval should stay at or below 9 (512 seconds). The default is 10 (1024 seconds), the minimum is -6 (1/64th of a second), and the maximum is 24 (6 months).
- **minpoll (-6-24):**  
This option specifies the minimum interval between requests sent to the server as a power of 2 in seconds. For example, `minpoll 5` would mean that the polling interval should not drop below 32 seconds. The default is 6 (64 seconds), the minimum is -6 (1/64th of a second), and the maximum is 24 (6 months). Note that intervals shorter than 6 (64 seconds) should generally not be used with public servers on the Internet, because it might be considered abuse. A sub-second interval will be enabled only when the server is reachable and the round-trip delay is shorter than 10 milliseconds, i.e. the server should be in a local network.
- **prefer:**  
Prefer this source over sources without the `prefer` option.
- **version (3-4):**  
This option sets the NTP version of packets sent to the server. The default version is 4.

Example:

```
soodar(config)# ntp server ir.pool.ntp.org burst iburst version
```

#### **no ntp server SERVER [OPTIONS]**

Remove an existing NTP server from list.

## Setting up NTP Authentication

The NTP protocol supports a message authentication code (MAC) to prevent computers from having their system time upset by the rogue packets being sent to them. The MAC is generated as a password function specified in the `ntp key-authentication` list.

### Add a New Key

Each key is made of an `id`, a `hash` function and the `key` value, so users need to provide these three to create a new key.

#### **ntp authentication-key (1-65535) sha1 WORD**

Add a new key to the list of authentication keys. Users can choose a key-id in (1-65535) range, SHA1 as its hash function and WORD as the key itself.

### Remove a key

To remove a key, knowing `key-id` is the only necessity.

#### **no ntp authentication-key (1-65535)**

Remove a key from the keys database. The key-id should be provided.

## Enabling and Disabling NTP Authentication

The NTP authentication mechanism only takes effect after it's been explicitly enabled. Without it, all connections to servers that are configured to use authentication would switch to simple unauthenticated mode. Vice versa, one can disable all NTP authentications by simply disabling them.

#### **ntp authentication**

Enable NTP authentication mode.

#### **no ntp authentication**

Disable NTP authentication mode.

## Showing NTP status

You can see information about current time sources that the client is accessing by issuing `show ntp sources` command

#### **show ntp sources [json]**

Print current server information.

Example:

Also a json output is available:

```
soodar(config)# do show ntp sources json
{
  "servers": [
    {
      "mode": "^",
```

(continues on next page)

```
soodar# show ntp sources
```

```

.-- Source mode  '^' = server, '=' = peer, '#' = local clock.
/  .-- Source state '*' = current best, '+' = combined, '-' = not combined,
| /          'x' = may be in error, '~' = too variable, '?' = unusable.
||
||          Reachability register (octal) --.          .- xxxx [ yyyy ] +/- zzzz
||          Log2(Polling interval) --.          |          xxxx = adjusted offset,
||          \          |          |          yyyy = measured offset,
||          \          |          |          zzzz = estimated error.
||
MS Name/IP address          Stratum Poll Reach LastRx Last sample
=====
^* 77.104.70.70              3      8    347   249   +1050us[+1527us] +/- 103ms

```

(continued from previous page)

```

"state": "*",
"address": "194.225.50.25",
"stratum": "3",
"polling_interval": "6",
"reachability_register": "17",
"last_rx": "6",
"adjusted_offset": "0.000333353",
"measured_offset": "-0.001453500",
"estimated_error": "0.094937660"
}
]
}

```

Also, you can see information about the drift rate and offset estimation process for each of the sources currently being examined by the client.

**show ntp sources stats**

Print offset estimation for sources.

Example:

```
soodar# show ntp sources stats
```

```

.-- Number of sample points in measurement set.
/  .-- Number of residual runs with same sign.
| /  .-- Length of measurement set (time).
| /  .-- Est. clock freq error (ppm).
| /  .-- Est. error in freq.
| /  .-- Est. offset.
|   On the --.
|   samples. \
Name/IP Address          NP  NR  Span  Frequency  Freq Skew  Offset  Std Dev
=====
77.104.70.70             24  17  39m   +0.038     3.994   +9768ns  3015us

```



## Manual clock

If you have no or restricted internet connection, you can disable NTP and set the date manually.

### **no ntp**

Disable NTP service and remove all its configurations( servers)

---

**Note:** NTP service is enabled by default. You should explicitly disable it. To reenale it, just set up NTP and add a server

---

### **clock set TIME (1-12) (1-31) (2000-4192)**

Set clock. TIME is current time in hh:mm:ss format.

## 1.2.9 IPv6 Support

SoodarOS fully supports IPv6 routing. As described so far, SoodarOS supports RIPng, OSPFv3, and BGP-4+. You can give IPv6 addresses to an interface and configure static IPv6 routing information. SoodarOS IPv6 also provides automatic address configuration via a feature called `address auto configuration`. To do it, the router must send router advertisement messages to the all nodes that exist on the network.

Previous versions of SoodarOS could be built without IPv6 support. This is no longer possible.

### Enable IPv6

To use IPv6 features, first it's needed to be enabled on interface. There are 2 ways to enable IPv6 on an interface: #. Issue `ipv6 enable` command #. Add an IPv6 address

#### **ipv6 enable**

Enable IPv6 on the interface

**Warning:** Note that IPv6 can't be enabled on virtual interfaces( like *tunnels* and *loopbacks*).

---

**Note:** Although tunnels can't have IPv6 addresses, but they can be passed through IPv6 network( source and destination can be IPv6).

---

### Router Advertisement

#### **no ipv6 nd suppress-ra**

Send router advertisement messages.

#### **ipv6 nd suppress-ra**

Don't send router advertisement messages.

#### **ipv6 nd prefix ipv6prefix [valid-lifetime] [preferred-lifetime] [off-link] [no-autoconfig] [router-address]**

Configuring the IPv6 prefix to include in router advertisements. Several prefix specific optional parameters and flags may follow:

- **valid-lifetime**: the length of time in seconds during what the prefix is valid for the purpose of on-link determination. Value `infinite` represents infinity (i.e. a value of all one bits (`0xffffffff`)). Range: (`0-4294967295`) Default: `2592000`
- **preferred-lifetime**: the length of time in seconds during what addresses generated from the prefix remain preferred. Value `infinite` represents infinity. Range: (`0-4294967295`) Default: `604800`
- **off-link**: indicates that advertisement makes no statement about on-link or off-link properties of the prefix. Default: not set, i.e. this prefix can be used for on-link determination.
- **no-autoconfig**: indicates to hosts on the local link that the specified prefix cannot be used for IPv6 autoconfiguration.  
Default: not set, i.e. prefix can be used for autoconfiguration.
- **router-address**: indicates to hosts on the local link that the specified prefix contains a complete IP address by setting R flag.  
Default: not set, i.e. hosts do not assume a complete IP address is placed.

**[no] ipv6 nd ra-interval [(1-1800)]**

The maximum time allowed between sending unsolicited multicast router advertisements from the interface, in seconds. Default: `600`

**[no] ipv6 nd ra-interval [msec (70-1800000)]**

The maximum time allowed between sending unsolicited multicast router advertisements from the interface, in milliseconds. Default: `600000`

**[no] ipv6 nd ra-fast-retrans**

RFC4861 states that consecutive RA packets should be sent no more frequently than three seconds apart. FRR by default allows faster transmissions of RA packets in order to speed convergence and neighbor establishment, particularly for unnumbered peering. By turning off `ipv6 nd ra-fast-retrans`, the implementation is compliant with the RFC at the cost of slower convergence and neighbor establishment. Default: `enabled`

**[no] ipv6 nd ra-retrans-interval [(0-4294967295)]**

The value to be placed in the retrans timer field of router advertisements sent from the interface, in msec. Indicates the interval between router advertisement retransmissions. Setting the value to zero indicates that the value is unspecified by this router. Must be between zero or 4294967295 msec. Default: `0`

**[no] ipv6 nd ra-hop-limit [(0-255)]**

The value to be placed in the hop count field of router advertisements sent from the interface, in hops. Indicates the maximum diameter of the network. Setting the value to zero indicates that the value is unspecified by this router. Must be between zero or 255 hops. Default: `64`

**[no] ipv6 nd ra-lifetime [(0-9000)]**

The value to be placed in the Router Lifetime field of router advertisements sent from the interface, in seconds. Indicates the usefulness of the router as a default router on this interface. Setting the value to zero indicates that the router should not be considered a default router on this interface. Must be either zero or between value specified with `ipv6 nd ra-interval` (or default) and 9000 seconds. Default: `1800`

**[no] ipv6 nd reachable-time [(1-3600000)]**

The value to be placed in the Reachable Time field in the Router Advertisement messages sent by the router, in milliseconds. The configured time enables the router to detect unavailable neighbors. The value zero means unspecified (by this router). Default: `0`

**[no] ipv6 nd managed-config-flag**

Set/unset flag in IPv6 router advertisements which indicates to hosts that they should use managed (stateful) protocol for addresses autoconfiguration in addition to any addresses autoconfigured using stateless address autoconfiguration. Default: not set

**[no] ipv6 nd other-config-flag**

Set/unset flag in IPv6 router advertisements which indicates to hosts that they should use administered (stateful) protocol to obtain autoconfiguration information other than addresses. Default: not set

**[no] ipv6 nd home-agent-config-flag**

Set/unset flag in IPv6 router advertisements which indicates to hosts that the router acts as a Home Agent and includes a Home Agent Option. Default: not set

**[no] ipv6 nd home-agent-preference [(0-65535)]**

The value to be placed in Home Agent Option, when Home Agent config flag is set, which indicates to hosts Home Agent preference. The default value of 0 stands for the lowest preference possible. Default: 0

**[no] ipv6 nd home-agent-lifetime [(0-65520)]**

The value to be placed in Home Agent Option, when Home Agent config flag is set, which indicates to hosts Home Agent Lifetime. The default value of 0 means to place the current Router Lifetime value.

Default: 0

**[no] ipv6 nd adv-interval-option**

Include an Advertisement Interval option which indicates to hosts the maximum time, in milliseconds, between successive unsolicited Router Advertisements. Default: not set

**[no] ipv6 nd router-preference [(high|medium|low)]**

Set default router preference in IPv6 router advertisements per RFC4191. Default: medium

**[no] ipv6 nd mtu [(1-65535)]**

Include an MTU (type 5) option in each RA packet to assist the attached hosts in proper interface configuration. The announced value is not verified to be consistent with router interface MTU.

Default: don't advertise any MTU option.

**[no] ipv6 nd rdns ipv6address [lifetime]**

Recursive DNS server address to advertise using the RDNS (type 25) option described in RFC8106. Can be specified more than once to advertise multiple addresses. Note that hosts may choose to limit the number of RDNS addresses to track.

Optional parameter:

- **lifetime**: the maximum time in seconds over which the specified address may be used for domain name resolution. Value **infinite** represents infinity (i.e. a value of all one bits (0xffffffff)). A value of 0 indicates that the address must no longer be used. Range: (0-4294967295) Default: 3 \* ra-interval

Default: do not emit RDNS option

**[no] ipv6 nd dnssl domain-name-suffix [lifetime]**

Advertise DNS search list using the DNSSL (type 31) option described in RFC8106. Specify more than once to advertise multiple domain name suffixes. Host implementations may limit the number of honored search list entries.

Optional parameter:

- **lifetime**: the maximum time in seconds over which the specified domain suffix may be used in the course of name resolution. Value **infinite** represents infinity (i.e. a value of all one bits (0xffffffff)). A value of 0 indicates that the name suffix must no longer be used. Range: (0-4294967295) Default: 3 \* ra-interval

Default: do not emit DNSSL option

## Router Advertisement Configuration Example

A small example:

```
interface ge0
  ipv6 enable
  ipv6 address 2001:1::1/64
  no ipv6 nd suppress-ra
  ipv6 nd prefix 2001:1::/64
```

See also:

- [RFC 2462](#) (IPv6 Stateless Address Autoconfiguration)
- [RFC 4861](#) (Neighbor Discovery for IP Version 6 (IPv6))
- [RFC 6275](#) (Mobility Support in IPv6)
- [RFC 4191](#) (Default Router Preferences and More-Specific Routes)
- [RFC 8106](#) (IPv6 Router Advertisement Options for DNS Configuration)

### 1.2.10 IPFIX

Internet Protocol Flow Information Export (IPFIX) is an IETF protocol and the name of the IETF working group defining the protocol. It was created based on the need for a common, universal standard of export for Internet Protocol flow information from routers, probes and other devices that are used by mediation systems, accounting/billing systems and network management systems to facilitate services such as measurement, accounting, and billing. The IPFIX standard defines how IP flow information is formatted and transferred from an exporter to a collector.

#### IPFIX flow exporter

IPFIX exporter information is configured and saved as `flow exporter`.

#### Commands

##### **flow exporter**

Enter flow exporter configuration mode

##### **destination A.B.C.D**

Set IPFIX flow collector IPv4 address

##### **source A.B.C.D**

Set IPFIX flow packets source. This address should be valid on the router.

##### **transport udp (1-65535)**

Define destination port

## IPFIX flow monitor

IPFIX flow definitions

### Commands

#### **flow monitor**

Enter flow monitor configuration mode

#### **cache timeout active (1-604800)**

Set active flow cache timeout in seconds

#### **cache timeout inactive (1-604800)**

Set inactive flow cache timeout in seconds

#### **record netflow <ipv4|ipv6> prefix-port**

Start recording flows information containing 5-tuple of source address, destination address, protocol, source port, and destination port.

#### **no record netflow <ipv4|ipv6> prefix-port**

stop recording flows information

#### **ip flow monitor output**

Apply flow monitor on an interface output

#### **no ip flow monitor output**

Remove flow monitor on an interface output

### Logging

Debugging logs can be set in case of need.

#### **[no] debug ipfix event**

log data plane installation processes and results

### Setup IPFIX

To setup IPFIX, one needs to do three things:

1. Define flow exporter
2. Define flow monitor
3. Apply monitor on 1 or more interfaces to collect data

## Example configuration

```
soodar(config)# interface ge3
soodar(config-if)# ip address 192.168.1.10/24
soodar(config-if)# flow exporter
soodar(config-flow-exporter)# destination 192.168.1.20
soodar(config-flow-exporter)# source 192.168.1.10
soodar(config-flow-exporter)# transport udp 15200
soodar(config-flow-exporter)# flow monitor
soodar(config-flow-monitor)# cache timeout active 1800
soodar(config-flow-monitor)# cache timeout inactive 15
soodar(config-flow-monitor)# record netflow ipv4 prefix-port
soodar(config-flow-monitor)# interface ge0
soodar(config-if)# ip flow monitor output
```

## 1.2.11 DHCP

From [RFC 2131](#):

The DHCP (Dynamic Host Configuration Protocol) provides a framework for passing configuration information to hosts on a TCP/IP network.

DHCP utilizes a server/client model to deliver the protocol. DHCP servers allocate network addresses to clients and provide them with network configurations.

### DHCP Server

Soodar uses [Kea DHCP](#) as a backend to provide DHCP server functionalities. These functionalities include:

- Add IP pools and define subnet and IP ranges to allocate to hosts
- Provide clients DNS server addresses
- Provide clients gateway address
- Provide clients NTP server addresses
- Set leasing time for each pool
- Show/Clear bindings

### Configuring Pool

#### [no] ip dhcp pool DHCP4POOL

Create a new DHCP4 pool. Each pool has a subnet. This subnet determines which pool should be used for incoming requests by matching the pool's subnet with the ingress interface subnet. The negated form removes a pool from pools.

```
soodar(config)# ip dhcp pool p1
soodar(dhcp-config)#
```

#### [no] network A.B.C.D/M

Set pool's subnet address.

```
soodar(config)# ip dhcp pool p1
soodar(dhcp-config)# network 192.168.1.0/24
```

**[no] included-address A.B.C.D A.B.C.D**

Define a range of addresses that could be used for allocating to clients from the subnet. Each pool can have multiple ``included-address`` commands.

```
soodar(config)# ip dhcp pool p1
soodar(dhcp-config)# included-address 192.168.1.100 192.168.1.120
soodar(dhcp-config)# included-address 192.168.1.140 192.168.1.165
```

**[no] dns-server A.B.C.D ...**

Configure DNS server address(es) that is fed to clients. Users can provide all addresses in one command or issue multiple commands.

---

**Note:** Up to 8 DNS servers can be set. It is not allowed to set more than 8 servers.

---

Example:

Following lines set 1.1.1.1, 4.2.2.4 and 8.8.8.8 as DNS servers:

```
soodar(config)# ip dhcp pool p1
soodar(dhcp-config)# dns-server 4.2.2.4 1.1.1.1
soodar(dhcp-config)# dns-server 8.8.8.8
```

**[no] default-router A.B.C.D ...**

Set gateway address(es) for presenting to clients. Users can provide all addresses in one command or issue multiple commands.

---

**Note:** Up to 8 gateway can be set. It is not allowed to set more than 8 addresses.

---

```
soodar(config)# ip dhcp pool p1
soodar(dhcp-config)# default-router 192.168.1.1
```

**[no] ntp-server NTP ...**

Configure NTP server address(es) that is fed to clients. Users can provide all addresses in one command or issue multiple commands.

---

**Note:** Up to 8 NTP servers can be set. It is not allowed to set more than 8 servers.

---

```
soodar(config)# ip dhcp pool p1
soodar(dhcp-config)# ntp-server ir.pool.ntp.org
```

**[no] domain-name NAME**

Specifies the domain name for clients

```
soodar(config)# ip dhcp pool p1
soodar(dhcp-config)# domain-name example.org
```

**[no] lease <(0-365) (0-23) (0-59)|infinite>**

Set DHCP lease time in days, hours, and minutes or infinite to disable lease time. The default lease time is 24 hours (1 day). Negating resets lease time to the default value.

```
soodar(config)# ip dhcp pool p1
soodar(dhcp-config)# ! set lease time to 30 days
soodar(dhcp-config)# lease 30 0 0
```

## Configure interfaces

**[no] ip dhcp server**

Enable DHCP serving on the interface. Negation disables DHCP serving.

```
soodar(config-if)# ip dhcp server
```

## Pool status and management

**show ip dhcp pool**

Show general information about a pool(s)

```
soodar# show ip dhcp pool p1

Pool p1 :
Total addresses: 47
Leased addresses:      1
Declined addresses:    0
2 ranges are currently in the pool :
Range's low      Range's high
192.168.1.100    192.168.1.120
192.168.1.140    192.168.1.165
```

**show ip dhcp binding [<DHCP4POOL|A.B.C.D>]**

Show information about current bindings.

```
soodar# show ip dhcp binding
  IP Address  Client hostname  Client HW address  Lease expiration
↪Pool  Type      State
  1.1.1.100   n4               00:00:00:aa:00:01  Wed Nov  3 11:20:06 2021  p2
↪   Automatic  Leased
```

**clear ip dhcp binding <\*|A.B.C.D>**

Removes a binding from the lease database. If \* is the input argument, clears all bindings



## 1.2.12 License

SoodarOS uses a license manager to allow users to choose their plans and use the trial version flexibly. To change the licensing, one needs to create a license request and send it to the corporation for signing. Once the signed certificate is imported, its effect is immediate.

### Default license

When SoodarOS lacks a license file, it continues to work. But restrictions are applied. These restrictions are:

- Drop supporting ethernet faster than Gigabit ethernet.
- Support a maximum of 8 hardware interfaces.
- Limit VPLS interfaces count to 5.
- Limit VXLAN interfaces count to 4.
- Limit protected tunnels to 2 tunnels.
- Support up to 10 Access-list.
- Limit access-list entries to 10 per ACL.
- Support up to 2 Policy map.
- NAT44 IP pool is limited to 32 IPs.
- NAT44 static entries are limited to 32 entries.
- Limit VRFs to 2 VRFs( not counting default VRF).
- Limit routes per VRF to 64.

### License request

To import a license, an enrollment is needed. SoodarOS makes a license request on user demand and displays it on the screen to achieve this. The displayed request should be sent for signing.

#### **license generate license-request [terminal]**

Generate license requests and display them on screen.

### Import license

Importing a signed license is by copy-pasting the license on the screen.

### Check license

To verify the license, `license check` command is used. If there are errors, they are printed on the screen.

#### **license check**

Check installed license.

## Show license

Checking current limits( and used quotas) is done via `show license` command.

### show license

Show current license limits.

---

**Note:** A negative value for a resource limit means that the resource is unlimited.

---

Example :

```
n1# show license
-----
      Name      Limit  Used
-----
Hardware Interfaces      8      3
Hardware Interfaces Type  1      -
      VPLS Interfaces      5      0
      VXLAN Interfaces      4      0
Protected Tunnels        2      1
      QoS Policy            2      0
      NAT44 Pool IPs        32     0
NAT44 Static Entries     32     0
      VRF                    2      0
VRF default routes       64     2
      ACL                     10     0

BGP Support: Available
MPLS Support: Available
VRF Support: Available
MP-GRE Support: Not available
EIGRP Support: Not available
IPv6 Support: Not available
```

## 1.3 Tune

### 1.3.1 System Tune

SoodarOS consist of services working together. These services can be categorized into three classes:

- Data-plane Services
- Control-plane Services
- Management Services

## Data-plane Services

Data-plane services are responsible for forwarding, routing, and filtering incoming packets.

### Members

#### VPP

VPP (Vector Packet Processing) is a fast, scalable layer 2-4 multi-platform network stack.

## Control-plane Services

All services related to signaling and routing protocols are in this class.

### Members

#### FRRouting

FRRouting (FRR) is a free and open-source Internet routing protocol suite.

#### Strongswan

IPSec/IKEv2 implementation

## Management Services

Services responsible for connecting from outside to SoodarOS.

### Members

#### OpenSSH

OpenSSH is a suite of secure networking utilities based on the SSH (Secure SHell) protocol.

### Tweaks

Depending on each use case's needs, admins can tweak services and their resources. These tweaks are defined as Tuning profiles.

### Common tweaks

For all above three categories of services, the following parameters can be set:

- CPU cores: Admin can specify CPU cores that the service is allowed to utilize. This core pinning is done in two ways:
  - Exclusive: The core is only assigned to this service and is not used in OS Scheduler.
  - Shared: The core lists in OS Scheduler and other processes can use them.

---

**Note:** For data-plane services, CPU core assigning is done differently. refer to *Data-plane tweaks*

---

- CPU weight: In case of shared CPUs, The available CPU time is split up among all services relative to their CPU time weight. A higher weight means more CPU time, a lower weight means less. The allowed range is 1 to 10000. Defaults to 100 for all processes.
- Maximum memory: Specify the absolute limit on memory usage of the executed processes in this class.

### Data-plane tweaks

VPP as a sophisticated and high-performance network has lots of customizable options.

### Data-plane CPU configuration

VPP needs at least one main thread and more optional worker threads. Each of These threads is pinned to a CPU core. The default configuration uses core 0 as the main thread( in shared mode) and no workers. Admin can set main thread/ worker threads, CPU exclusiveness, and service CPU weight.

### Data-plane Memory configuration

VPP uses its memory management system, so in the beginning, it ``mmap``s needed memories from OS heap.

- Main heap: VPP's main memory. Used to store ACL rules, IP Routes,... . Defaults to 1GB.
- Stat heap: Memory assigned to storing stats( like packets count). Defaults to 32MB.

Admin can change these values when needed.

### Data-plane buffer configuration

VPP uses per NUMA pre-allocated buffers to process incoming packets. It's advised not to change default values, but admins can change the number of buffers and buffer size.

### Data-plane poll sleep

VPP's main loop poll always fetches new packets and uses 100% CPU. An admin can add a fixed sleep between the main loop poll to lower the power usage, CPU usage, and heat production in small devices.

<b>Warning:</b> Enabling poll sleep can cause performance degradation.
--

### Interface order configuration

Network interfaces are sorted by their PCI address. For example, a router with 4 network interfaces and their respective addresses is mapped like:

Table 1: Interfaces' list( original)

PCI Address	Order	Interface Name	MAC Address
00:04.0	0	ge0	0c:61:0c:83:00:00
00:05.0	1	ge1	0c:61:0c:83:00:01
00:06.0	2	ge2	0c:61:0c:83:00:02
00:07.0	3	ge3	0c:61:0c:83:00:03

Under some circumstances, admins may be willing to change this order. SoodarOS Tuning Profiles supports static interface order based on MAC address. Interfaces without a static order use the explained order. For instance, in the above example admin sets the order of MAC address `0c:61:0c:83:00:00` as 2. The resulting interface list is:

Table 2: Interfaces' list( reordered)

PCI Address	Order	Interface Name	MAC Address
00:04.0	2	ge2	0c:61:0c:83:00:00
00:05.0	0	ge0	0c:61:0c:83:00:01
00:06.0	1	ge1	0c:61:0c:83:00:02
00:07.0	3	ge3	0c:61:0c:83:00:03

## CLI Commands

### Adding/ Removing tuning profile

#### **system tune profile TPROF**

Create and Enter Tuning Profile configuration

#### **no system tune profile TPROF**

Removes a Tuning profile.

---

**Note:** Removing current profile does **not** apply default configuration to the system.

---

```
soodar(config)# system tune profile max-perf
soodar(tune-profile)#
```

## Configuring Data-plane

### **data-plane**

Enter Data-plane configuration node.

## Configuring Data-plane CPU

### **cpu main [exclusive] (1-256)**

Assign entered CPU core as VPP main thread core. If **exclusive** keyword is used, isolate the CPU core from the OS scheduler.

### **no cpu main [[exclusive] (1-256)]**

Change current assigned CPU to the main thread to default( Shared CPU 0).

### **cpu worker [exclusive] (1-256)...**

Add a list of CPU cores to be used as VPP worker threads. If **exclusive** keyword is used, isolate CPU cores from the OS scheduler.

### **no cpu worker [[exclusive] (1-256)]**

Remove a list of CPU cores from VPP worker threads. If command is used without any input, remove all VPP worker threads.

### **cpu weight (1-10000)**

Set the service CPU time weight. Useful when CPU cores are shared between the OS scheduler and the service.

### **no cpu weight [(1-10000)]**

Change the service CPU time weight to the default value of 100.

```
soodar(config)# system tune profile max-perf
soodar(tune-profile)# data-plane
soodar(tune-dp-cfg)# cpu main exclusive 1
soodar(tune-dp-cfg)# cpu worker exclusive 2 3 4 5
soodar(tune-dp-cfg)# cpu worker 6 7
```

## Configuring Data-plane Memory

### **memory max SIZE**

Limit the service maximum available memory to SIZE value. SIZE can be in bytes, human-readable format, or a percentage of the system's total memory.

### **no memory max [SIZE]**

Remove the service memory usage limit.

### **memory heap main SIZE**

Set the VPP main heap size to SIZE value.

### **no memory heap main [SIZE]**

Reset the VPP main heap size to the default value of 1GB.

### **memory heap stats SIZE**

Set the VPP stats heap size to SIZE value.

### **no memory heap stats [SIZE]**

Reset the VPP stats heap size to the default value of 32MB.

```
soodar(config)# system tune profile max-perf
soodar(tune-profile)# data-plane
soodar(tune-dp-cfg)# memory heap main 2G
soodar(tune-dp-cfg)# memory heap stats 64M
soodar(tune-dp-cfg)# memory max 4G
```

## Configuring Data-plane Buffers

### **memory packet-buffer size (2048-65536)**

Set the packet buffer's data segment size.

### **no memory packet-buffer size [(2048-65536)]**

Reset the packet buffer's data segment size to the default value of 2048.

### **memory packet-buffer count (16384-1049776)**

Set the data-plane packet buffers' count.

### **no memory packet-buffer count [(16384-1049776)]**

Reset the data-plane packet buffers' count to the default value of 16384

**Warning:** Changing buffer values can affect performance, and default values are the optimized values for most use cases.

## Configuring Data-plane Poll Sleep

### **poll sleep (0-10000)**

Set fixed sleep between VPP's main loop polls. The sleep is in microseconds.

### **no poll sleep [(0-10000)]**

Disable fixed sleep between VPP's main loop polls.

```
soodar(config)# system tune profile max-perf
soodar(tune-profile)# data-plane
soodar(tune-dp-cfg)# poll sleep 100
```

## Configuring Control-plane

### **control-plane**

Enter Control-plane configuration node.

## Configuring Control-plane CPU

### **cpu [exclusive] (1-256)...**

Add a list of CPU cores for threads of this class's services. If **exclusive** keyword is used, isolate CPU cores from the OS scheduler.

### **no cpu worker [[exclusive] (1-256)]**

Remove a list of CPU cores from services of this class. If the command is used without any input, remove all CPUs.

### **cpu weight (1-10000)**

Set the service CPU time weight. Useful when CPU cores are shared between the OS scheduler and the service.

### **no cpu weight [(1-10000)]**

Change the service CPU time weight to the default value of 100.

```
soodar(config)# system tune profile max-perf
soodar(tune-profile)# control-plane
soodar(tune-cp-cfg)# cpu exclusive 8
soodar(tune-cp-cfg)# cpu 9 10
soodar(tune-cp-cfg)# cpu weight 1000
```

## Configuring Control-plane Memory

### **memory max SIZE**

Limit the service maximum available memory to SIZE value. SIZE can be in bytes, human-readable format, or a percentage of the system's total memory.

### **no memory max [SIZE]**

Remove the service memory usage limit.

```
soodar(config)# system tune profile max-perf
soodar(tune-profile)# control-plane
soodar(tune-cp-cfg)# memory max 16G
```

## Configuring Management Plane

### **management-plane**

Enter Management-plane configuration node.

## Configuring Management-plane CPU

### **cpu [exclusive] (1-256)...**

Add a list of CPU cores for threads of this class's services. If **exclusive** keyword is used, isolate CPU cores from the OS scheduler.

### **no cpu worker [[exclusive] (1-256)]**

Remove a list of CPU cores from services of this class. If the command is used without any input, remove all CPUs.

### **cpu weight (1-10000)**

Set the service CPU time weight. Useful when CPU cores are shared between the OS scheduler and the service.

### **no cpu weight [(1-10000)]**

Change the service CPU time weight to the default value of 100.

```
soodar(config)# system tune profile max-perf
soodar(tune-profile)# control-plane
soodar(tune-mgmt-cfg)# cpu exclusive 11
```



## Configuring management-plane Memory

### **memory max SIZE**

Limit the service maximum available memory to SIZE value. SIZE can be in bytes, human-readable format, or a percentage of the system's total memory.

### **no memory max [SIZE]**

Remove the service memory usage limit.

```
soodar(config)# system tune profile max-perf
soodar(tune-profile)# control-plane
soodar(tune-mgmt-cfg)# memory max 1G
```

## Applying tuning profile

After creating a tuning profile, one can apply this profile to SoodarOS by using the following commands.

### **system tune apply PROFILE**

Apply PROFILE to SoodarOS. To changes take effect, a machine restart is needed.

### **system tune apply default**

Apply default profile to SoodarOS. To changes take effect, a machine restart is needed.

## Tips

- CPU 0 is always used by the SoodarOS kernel. Try to assign services to other cores.
- It is best to use exclusive CPU cores for data-plane's threads( main or workers).
- One or 2 cores should be enough for control-plane and management-plane services, even they can be shared with the system kernel.
- Memory usage usually is not a concern, and limiting the memory usage could be skipped.
- Put all cores of your router to use!

## 1.4 Protocols

### 1.4.1 Bidirectional Forwarding Detection

BFD (Bidirectional Forwarding Detection) stands for Bidirectional Forwarding Detection and it is described and extended by the following RFCs:

- [RFC 5880](#)
- [RFC 5881](#)
- [RFC 5883](#)

## BFDd Commands

### bfd

Opens the BFD daemon configuration node.

```
peer <A.B.C.D|X:X::X:X> [{multihop|local-address <A.B.C.D|X:X::X:X>|interface IFNAME|vrf NAME}]
```

Creates and configures a new BFD peer to listen and talk to.

*multihop* tells the BFD daemon that we should expect packets with TTL less than 254 (because it will take more than one hop) and to listen on the multihop port (4784). When using multi-hop mode *echo-mode* will not work (see [RFC 5883](#) section 3).

*local-address* provides a local address that we should bind our peer listener to and the address we should use to send the packets. This option is mandatory for IPv6.

*interface* selects which interface we should use.

*vrf* selects which domain we want to use.

```
no peer <A.B.C.D|X:X::X:X>$peer [{multihop|local-address <A.B.C.D|X:X::X:X>$local|interface IFNAME$ifname|vrf NAME$vrf_name}]
```

Stops and removes the selected peer.

### profile WORD

Creates a peer profile that can be configured in multiple peers.

### no profile WORD

Deletes a peer profile. Any peer using the profile will have their configurations reset to the default values.

```
show bfd [vrf NAME] peers [json]
```

Show all configured BFD peers information and current status.

```
show bfd [vrf NAME$vrf_name] peer <WORD$label|<A.B.C.D|X:X::X:X>$peer [{multihop|local-address <A.B.C.D|X:X::X:X>$local|interface IFNAME$ifname}]> [json]
```

Show status for a specific BFD peer.

```
show bfd [vrf NAME] peers brief [json]
```

Show all configured BFD peers information and current status in brief.

## Peer / Profile Configuration

BFD peers and profiles share the same BFD session configuration commands.

### detect-multiplier (2-255)

Configures the detection multiplier to determine packet loss. The remote transmission interval will be multiplied by this value to determine the connection loss detection timer. The default value is 3.

Example: when the local system has *detect-multiplier 3* and the remote system has *transmission interval 300*, the local system will detect failures only after 900 milliseconds without receiving packets.

### receive-interval (10-60000)

Configures the minimum interval that this system is capable of receiving control packets. The default value is 300 milliseconds.

**transmit-interval (10-60000)**

The minimum transmission interval (less jitter) that this system wants to use to send BFD control packets. Defaults to 300ms.

**echo-interval (10-60000)**

Configures the minimal echo receive transmission interval that this system is capable of handling.

**[no] echo-mode**

Enables or disables the echo transmission mode. This mode is disabled by default.

It is recommended that the transmission interval of control packets to be increased after enabling echo-mode to reduce bandwidth usage. For example: *transmit-interval 2000*.

Echo mode is not supported on multi-hop setups (see [RFC 5883](#) section 3).

**[no] shutdown**

Enables or disables the peer. When the peer is disabled an 'administrative down' message is sent to the remote peer.

**[no] passive-mode**

Mark session as passive: a passive session will not attempt to start the connection and will wait for control packets from peer before it begins replying.

This feature is useful when you have a router that acts as the central node of a star network and you want to avoid sending BFD control packets you don't need to.

The default is active-mode (or no `passive-mode`).

**[no] minimum-ttl (1-254)**

For multi hop sessions only: configure the minimum expected TTL for an incoming BFD control packet.

This feature serves the purpose of tightening the packet validation requirements to avoid receiving BFD control packets from other sessions.

The default value is 254 (which means we only expect one hop between this system and the peer).

**BFD Peer Specific Commands****label WORD**

Labels a peer with the provided word. This word can be referenced later on other daemons to refer to a specific peer.

**profile BFDPROF**

Configure peer to use the profile configurations.

Notes:

- Profile configurations can be overridden on a peer basis by specifying new parameters in peer configuration node.
- Non existing profiles can be configured and they will only be applied once they start to exist.
- If the profile gets updated the new configuration will be applied to all peers with the profile without interruptions.

## BGP BFD Configuration

The following commands are available inside the BGP configuration node.

**neighbor <A.B.C.D|X:X::X:X|WORD> bfd**

Listen for BFD events registered on the same target as this BGP neighbor. When BFD peer goes down it immediately asks BGP to shutdown the connection with its neighbor and, when it goes back up, notify BGP to try to connect to it.

**no neighbor <A.B.C.D|X:X::X:X|WORD> bfd**

Removes any notification registration for this neighbor.

**neighbor <A.B.C.D|X:X::X:X|WORD> bfd check-control-plane-failure**

Allow to write CBIT independence in BFD outgoing packets. Also allow to read both C-BIT value of BFD and lookup BGP peer status. This command is useful when a BFD down event is caught, while the BGP peer requested that local BGP keeps the remote BGP entries as staled if such issue is detected. This is the case when graceful restart is enabled, and it is wished to ignore the BD event while waiting for the remote router to restart.

**no neighbor <A.B.C.D|X:X::X:X|WORD> bfd check-control-plane-failure**

Disallow to write CBIT independence in BFD outgoing packets. Also disallow to ignore BFD down notification. This is the default behaviour.

**neighbor <A.B.C.D|X:X::X:X|WORD> bfd profile BFDPROF**

Same as command `neighbor <A.B.C.D|X:X::X:X|WORD> bfd`, but applies the BFD profile to the sessions it creates or that already exist.

**no neighbor <A.B.C.D|X:X::X:X|WORD> bfd profile BFDPROF**

Removes the BFD profile configuration from peer session(s).

## IS-IS BFD Configuration

The following commands are available inside the interface configuration node.

**isis bfd**

Listen for BFD events on peers created on the interface. Every time a new neighbor is found a BFD peer is created to monitor the link status for fast convergence.

**no isis bfd**

Removes any notification registration for this interface peers.

Note that there will be just one BFD session per interface. In case both IPv4 and IPv6 support are configured then just a IPv6 based session is created.

**isis bfd profile BFDPROF**

Use a BFD profile BFDPROF as provided in the BFD configuration.

**no isis bfd profile BFDPROF**

Removes any BFD profile if present.

## OSPF BFD Configuration

The following commands are available inside the interface configuration node.

### **ip ospf bfd**

Listen for BFD events on peers created on the interface. Every time a new neighbor is found a BFD peer is created to monitor the link status for fast convergence.

### **no ip ospf bfd**

Removes any notification registration for this interface peers.

## OSPF6 BFD Configuration

The following commands are available inside the interface configuration node.

### **ipv6 ospf6 bfd**

Listen for BFD events on peers created on the interface. Every time a new neighbor is found a BFD peer is created to monitor the link status for fast convergence.

### **no ipv6 ospf6 bfd**

Removes any notification registration for this interface peers.

## Configuration

Before applying bfdd rules to integrated daemons (like BGPd), we must create the corresponding peers inside the bfd configuration node.

Here is an example of BFD configuration:

```
bfd
peer 192.168.0.1
  label home-peer
  no shutdown
!
!
router bgp 65530
neighbor 192.168.0.1 remote-as 65531
neighbor 192.168.0.1 bfd
neighbor 192.168.0.2 remote-as 65530
neighbor 192.168.0.2 bfd
neighbor 192.168.0.3 remote-as 65532
neighbor 192.168.0.3 bfd
!
```

Peers can be identified by its address (use `multihop` when you need to specify a multi hop peer) or can be specified manually by a label.

Here are the available peer configurations:

```
bfd
! Configure a fast profile
profile fast
  receive-interval 150
  transmit-interval 150
```

(continues on next page)

(continued from previous page)

```
!  
  
! Configure peer with fast profile  
peer 192.168.0.6  
  profile fast  
  no shutdown  
!  
  
! Configure peer with fast profile and override receive speed.  
peer 192.168.0.7  
  profile fast  
  receive-interval 500  
  no shutdown  
!  
  
! configure a peer on an specific interface  
peer 192.168.0.1 interface ge0  
  no shutdown  
!  
  
! configure a multihop peer  
peer 192.168.0.2 multihop local-address 192.168.0.3  
  shutdown  
!  
  
! configure a peer in a different vrf  
peer 192.168.0.3 vrf foo  
  shutdown  
!  
  
! configure a peer with every option possible  
peer 192.168.0.4  
  label peer-label  
  detect-multiplier 50  
  receive-interval 60000  
  transmit-interval 3000  
  shutdown  
!  
  
! configure a peer on an interface from a separate vrf  
peer 192.168.0.5 interface ge1 vrf vrf2  
  no shutdown  
!  
  
! remove a peer  
no peer 192.168.0.3 vrf foo
```

## Status

You can inspect the current BFD peer status with the following commands:

```
soodar# show bfd peers
BFD Peers:
  peer 192.168.0.1
    ID: 1
    Remote ID: 1
    Status: up
    Uptime: 1 minute(s), 51 second(s)
    Diagnostics: ok
    Remote diagnostics: ok
    Peer Type: dynamic
    Local timers:
      Detect-multiplier: 3
      Receive interval: 300ms
      Transmission interval: 300ms
      Echo transmission interval: disabled
    Remote timers:
      Detect-multiplier: 3
      Receive interval: 300ms
      Transmission interval: 300ms
      Echo transmission interval: 50ms

  peer 192.168.1.1
    label: router3-peer
    ID: 2
    Remote ID: 2
    Status: up
    Uptime: 1 minute(s), 53 second(s)
    Diagnostics: ok
    Remote diagnostics: ok
    Peer Type: configured
    Local timers:
      Detect-multiplier: 3
      Receive interval: 300ms
      Transmission interval: 300ms
      Echo transmission interval: disabled
    Remote timers:
      Detect-multiplier: 3
      Receive interval: 300ms
      Transmission interval: 300ms
      Echo transmission interval: 50ms

soodar# show bfd peer 192.168.1.1
BFD Peer:
  peer 192.168.1.1
    label: router3-peer
    ID: 2
    Remote ID: 2
    Status: up
    Uptime: 3 minute(s), 4 second(s)
```

(continues on next page)

(continued from previous page)

```

Diagnostics: ok
Remote diagnostics: ok
Peer Type: dynamic
Local timers:
    Detect-multiplier: 3
    Receive interval: 300ms
    Transmission interval: 300ms
    Echo transmission interval: disabled
Remote timers:
    Detect-multiplier: 3
    Receive interval: 300ms
    Transmission interval: 300ms
    Echo transmission interval: 50ms

soodar# show bfd peer 192.168.0.1 json
{"multihop":false,"peer":"192.168.0.1","id":1,"remote-id":1,"status":"up","uptime":161,
↪ "diagnostic":"ok","remote-diagnostic":"ok","receive-interval":300,"transmit-interval
↪ ":300,"echo-interval":50,"remote-receive-interval":300,"remote-transmit-interval":300,
↪ "remote-echo-interval":50,"remote-detect-multiplier":3,"peer-type":"dynamic"}

```

You can inspect the current BFD peer status in brief with the following commands:

```

soodar# show bfd peers brief
Session count: 1
SessionId  LocalAddress      PeerAddress      Status
=====  =====
1          192.168.0.1       192.168.0.2     up

```

You can also inspect peer session counters with the following commands:

```

soodar# show bfd peers counters
BFD Peers:
  peer 192.168.2.1 interface ge2
    Control packet input: 28 packets
    Control packet output: 28 packets
    Echo packet input: 0 packets
    Echo packet output: 0 packets
    Session up events: 1
    Session down events: 0
    Zebra notifications: 2

  peer 192.168.0.1
    Control packet input: 54 packets
    Control packet output: 103 packets
    Echo packet input: 965 packets
    Echo packet output: 966 packets
    Session up events: 1
    Session down events: 0
    Zebra notifications: 4

soodar# show bfd peer 192.168.0.1 counters
peer 192.168.0.1

```

(continues on next page)



(continued from previous page)

```

Control packet input: 126 packets
Control packet output: 247 packets
Echo packet input: 2409 packets
Echo packet output: 2410 packets
Session up events: 1
Session down events: 0
Zebra notifications: 4

soodar# show bfd peer 192.168.0.1 counters json
{"multihop":false,"peer":"192.168.0.1","control-packet-input":348,"control-packet-output
↪":685,"echo-packet-input":6815,"echo-packet-output":6816,"session-up":1,"session-down
↪":0,"zebra-notifications":4}

```

You can also clear packet counters per session with the following commands, only the packet counters will be reset:

```

soodar# clear bfd peers counters

soodar# show bfd peers counters
BFD Peers:
  peer 192.168.2.1 interface ge2
    Control packet input: 0 packets
    Control packet output: 0 packets
    Echo packet input: 0 packets
    Echo packet output: 0 packets
    Session up events: 1
    Session down events: 0
    Zebra notifications: 2

  peer 192.168.0.1
    Control packet input: 0 packets
    Control packet output: 0 packets
    Echo packet input: 0 packets
    Echo packet output: 0 packets
    Session up events: 1
    Session down events: 0
    Zebra notifications: 4

```

## Debugging

By default only informational, warning and errors messages are going to be displayed. If you want to get debug messages and other diagnostics then make sure you have *debugging* level enabled:

```

config
log syslog debugging

```

You may also fine tune the debug messages by selecting one or more of the debug levels:

### [no] debug bfd network

Toggle network events: show messages about socket failures and unexpected BFD messages that may not belong to registered peers.

### [no] debug bfd peer

Toggle peer event log messages: show messages about peer creation/removal and state changes.

**[no] debug bfd zebra**

Toggle zebra message events: show messages about interfaces, local addresses, VRF and daemon peer registrations.

## 1.4.2 BGP

BGP stands for Border Gateway Protocol. The latest BGP version is 4. BGP-4 is one of the Exterior Gateway Protocols and the de facto standard interdomain routing protocol. BGP-4 is described in [RFC 1771](#) and updated by [RFC 4271](#). [RFC 2858](#) adds multiprotocol support to BGP-4.

### Basic Concepts

#### Autonomous Systems

From [RFC 1930](#):

An AS is a connected group of one or more IP prefixes run by one or more network operators which has a SINGLE and CLEARLY DEFINED routing policy.

Each AS has an identifying number associated with it called an ASN (Autonomous System Number). This is a two octet value ranging in value from 1 to 65535. The AS numbers 64512 through 65535 are defined as private AS numbers. Private AS numbers must not be advertised on the global Internet.

The ASN is one of the essential elements of BGP. BGP is a distance vector routing protocol, and the AS-Path framework provides distance vector metric and loop detection to BGP.

**See also:**

[RFC 1930](#)

#### Address Families

Multiprotocol extensions enable BGP to carry routing information for multiple network layer protocols. BGP supports an Address Family Identifier (AFI) for IPv4 and IPv6. Support is also provided for multiple sets of per-AFI information via the BGP Subsequent Address Family Identifier (SAFI). FRR supports SAFIs for unicast information, labeled information ([RFC 3107](#) and [RFC 8277](#)), and Layer 3 VPN information ([RFC 4364](#) and [RFC 4659](#)).

#### Route Selection

The route selection process used by FRR's BGP implementation uses the following decision criterion, starting at the top of the list and going towards the bottom until one of the factors can be used.

1. **Weight check**

Prefer higher local weight routes to lower routes.

2. **Local preference check**

Prefer higher local preference routes to lower.

3. **Local route check**

Prefer local routes (statics, aggregates, redistributed) to received routes.

**4. AS path length check**

Prefer shortest hop-count AS\_PATHs.

**5. Origin check**

Prefer the lowest origin type route. That is, prefer IGP origin routes to EGP, to Incomplete routes.

**6. MED check**

Where routes with a MED were received from the same AS, prefer the route with the lowest MED. *Multi-Exit Discriminator*.

**7. External check**

Prefer the route received from an external, eBGP peer over routes received from other types of peers.

**8. IGP cost check**

Prefer the route with the lower IGP cost.

**9. Multi-path check**

If multi-pathing is enabled, then check whether the routes not yet distinguished in preference may be considered equal. If `bgp bestpath as-path multipath-relax` is set, all such routes are considered equal, otherwise routes received via iBGP with identical AS\_PATHs or routes received from eBGP neighbours in the same AS are considered equal.

**10. Already-selected external check**

Where both routes were received from eBGP peers, then prefer the route which is already selected. Note that this check is not applied if `bgp bestpath compare-routerid` is configured. This check can prevent some cases of oscillation.

**11. Router-ID check**

Prefer the route with the lowest *router-ID*. If the route has an *ORIGINATOR\_ID* attribute, through iBGP reflection, then that router ID is used, otherwise the *router-ID* of the peer the route was received from is used.

**12. Cluster-List length check**

The route with the shortest cluster-list length is used. The cluster-list reflects the iBGP reflection path the route has taken.

**13. Peer address**

Prefer the route received from the peer with the higher transport layer address, as a last-resort tie-breaker.

**Capability Negotiation**

When adding IPv6 routing information exchange feature to BGP. There were some proposals. IETF (Internet Engineering Task Force) IDR (Inter Domain Routing) adopted a proposal called Multiprotocol Extension for BGP. The specification is described in [RFC 2283](#). The protocol does not define new protocols. It defines new attributes to existing BGP. When it is used exchanging IPv6 routing information it is called BGP-4+. When it is used for exchanging multicast routing information it is called MBGP.

*bgpd* supports Multiprotocol Extension for BGP. So if a remote peer supports the protocol, *bgpd* can exchange IPv6 and/or multicast routing information.

Traditional BGP did not have the feature to detect a remote peer's capabilities, e.g. whether it can handle prefix types other than IPv4 unicast routes. This was a big problem using Multiprotocol Extension for BGP in an operational network. [RFC 2842](#) adopted a feature called Capability Negotiation. *bgpd* use this Capability Negotiation to detect

the remote peer's capabilities. If a peer is only configured as an IPv4 unicast neighbor, *bgpd* does not send these Capability Negotiation packets (at least not unless other optional BGP features require capability negotiation).

By default, FRR will bring up peering with minimal common capability for the both sides. For example, if the local router has unicast and multicast capabilities and the remote router only has unicast capability the local router will establish the connection with unicast only capability. When there are no common capabilities, FRR sends Unsupported Capability error and then resets the connection.

## BGP Router Configuration

### ASN and Router ID

First of all you must configure BGP router with the `router bgp ASN` command. The AS number is an identifier for the autonomous system. The BGP protocol uses the AS number for detecting whether the BGP connection is internal or external.

#### **router bgp ASN**

Enable a BGP protocol process with the specified ASN. After this statement you can input any *BGP Commands*.

#### **no router bgp ASN**

Destroy a BGP protocol process with the specified ASN.

#### **bgp router-id A.B.C.D**

This command specifies the router-ID. If *bgpd* connects to *zebra* it gets interface and address information. In that case default router ID value is selected as the largest IP Address of the interfaces. When *router zebra* is not enabled *bgpd* can't get interface information so *router-id* is set to 0.0.0.0. So please set router-id by hand.

## Multiple Autonomous Systems

FRR's BGP implementation is capable of running multiple autonomous systems at once. Each configured AS corresponds to a *zebra-vrf*. In the past, to get the same functionality the network administrator had to run a new *bgpd* process; using VRFs allows multiple autonomous systems to be handled in a single process.

When using multiple autonomous systems, all router config blocks after the first one must specify a VRF to be the target of BGP's route selection. This VRF must be unique within respect to all other VRFs being used for the same purpose, i.e. two different autonomous systems cannot use the same VRF. However, the same AS can be used with different VRFs.

---

**Note:** The separated nature of VRFs makes it possible to peer a single *bgpd* process to itself, on one machine. Note that this can be done fully within BGP without a corresponding VRF in the kernel or Zebra, which enables some practical use cases such as *route reflectors* and route servers.

---

Configuration of additional autonomous systems, or of a router that targets a specific VRF, is accomplished with the following command:

#### **router bgp ASN vrf VRFNAME**

VRFNAME is matched against VRFs configured in the kernel. When `vrf VRFNAME` is not specified, the BGP protocol process belongs to the default VRF.

An example configuration with multiple autonomous systems might look like this:

```

router bgp 1
  neighbor 10.0.0.1 remote-as 20
  neighbor 10.0.0.2 remote-as 30
!
router bgp 2 vrf blue
  neighbor 10.0.0.3 remote-as 40
  neighbor 10.0.0.4 remote-as 50
!
router bgp 3 vrf red
  neighbor 10.0.0.5 remote-as 60
  neighbor 10.0.0.6 remote-as 70
...

```

**See also:***VRF Route Leaking***See also:**

zebra-vrf

**Views**

In addition to supporting multiple autonomous systems, FRR's BGP implementation also supports *views*.

BGP views are almost the same as normal BGP processes, except that routes selected by BGP are not installed into the kernel routing table. Each BGP view provides an independent set of routing information which is only distributed via BGP. Multiple views can be supported, and BGP view information is always independent from other routing protocols and Zebra/kernel routes. BGP views use the core instance (i.e., default VRF) for communication with peers.

**router bgp AS-NUMBER view NAME**

Make a new BGP view. You can use an arbitrary word for the *NAME*. Routes selected by the view are not installed into the kernel routing table.

With this command, you can setup Route Server like below.

```

!
router bgp 1 view 1
  neighbor 10.0.0.1 remote-as 2
  neighbor 10.0.0.2 remote-as 3
!
router bgp 2 view 2
  neighbor 10.0.0.3 remote-as 4
  neighbor 10.0.0.4 remote-as 5

```

**show [ip] bgp view NAME**

Display the routing table of BGP view *NAME*.

## Route Selection

### **bgp bestpath as-path confed**

This command specifies that the length of confederation path sets and sequences should be taken into account during the BGP best path decision process.

### **bgp bestpath as-path multipath-relax**

This command specifies that BGP decision process should consider paths of equal AS\_PATH length candidates for multipath computation. Without the knob, the entire AS\_PATH must match for multipath computation.

### **bgp bestpath compare-routerid**

Ensure that when comparing routes where both are equal on most metrics, including local-pref, AS\_PATH length, IGP cost, MED, that the tie is broken based on router-ID.

If this option is enabled, then the already-selected check, where already selected eBGP routes are preferred, is skipped.

If a route has an *ORIGINATOR\_ID* attribute because it has been reflected, that *ORIGINATOR\_ID* will be used. Otherwise, the router-ID of the peer the route was received from will be used.

The advantage of this is that the route-selection (at this point) will be more deterministic. The disadvantage is that a few or even one lowest-ID router may attract all traffic to otherwise-equal paths because of this check. It may increase the possibility of MED or IGP oscillation, unless other measures were taken to avoid these. The exact behaviour will be sensitive to the iBGP and reflection topology.

## Administrative Distance Metrics

### **distance bgp (1-255) (1-255) (1-255)**

This command change distance value of BGP. The arguments are the distance values for external routes, internal routes and local routes respectively.

### **distance (1-255) A.B.C.D/M**

### **distance (1-255) A.B.C.D/M WORD**

Sets the administrative distance for a particular route.

## Require policy on EBGP

### **[no] bgp ebgp-requires-policy**

This command requires incoming and outgoing filters to be applied for eBGP sessions as part of RFC-8212 compliance. Without the incoming filter, no routes will be accepted. Without the outgoing filter, no routes will be announced.

This is enabled by default.

When you enable/disable this option you **MUST** clear the session.

When the incoming or outgoing filter is missing you will see "(Policy)" sign under `show bgp summary`:

```
exit1# show bgp summary
IPv4 Unicast Summary:
BGP router identifier 10.10.10.1, local AS number 65001 vrf-id 0
BGP table version 4
```

(continues on next page)

(continued from previous page)

```
RIB entries 7, using 1344 bytes of memory
Peers 2, using 43 KiB of memory
```

Neighbor	V	AS	MsgRcvd	MsgSent	TblVer	InQ	OutQ	Up/Down	State/
↪PfxRcd	PfxSnt								
192.168.0.2	4	65002	8	10	0	0	0	00:03:09	└─
↪	5 (Policy)								
fe80:1::2222	4	65002	9	11	0	0	0	00:03:09	└─
↪(Policy)	(Policy)								

Additionally a `show bgp neighbor` command would indicate in the *For address family:* block that:

```
exit1# show bgp neighbor
...
For address family: IPv4 Unicast
Update group 1, subgroup 1
Packet Queue length 0
Inbound soft reconfiguration allowed
Community attribute sent to this neighbor(all)
Inbound updates discarded due to missing policy
Outbound updates discarded due to missing policy
0 accepted prefixes
```

## Reject routes with AS\_SET or AS\_CONFED\_SET types

### [no] bgp reject-as-sets

This command enables rejection of incoming and outgoing routes having AS\_SET or AS\_CONFED\_SET type.

## Disable checking if nexthop is connected on EBGp sessions

### [no] bgp disable-ebgp-connected-route-check

This command is used to disable the connection verification process for EBGp peering sessions that are reachable by a single hop but are configured on a loopback interface or otherwise configured with a non-directly connected IP address.

## Route Flap Dampening

### bgp dampening (1-45) (1-20000) (1-20000) (1-255)

This command enables BGP route-flap dampening and specifies dampening parameters.

#### half-life

Half-life time for the penalty

#### reuse-threshold

Value to start reusing a route

#### suppress-threshold

Value to start suppressing a route

#### max-suppress

Maximum duration to suppress a stable route

The route-flap damping algorithm is compatible with [RFC 2439](#). The use of this command is not recommended nowadays.

At the moment, route-flap dampening is not working per VRF and is working only for IPv4 unicast and multicast.

### See also:

<https://www.ripe.net/publications/docs/ripe-378>

## Multi-Exit Discriminator

The BGP MED (Multi-Exit Discriminator) attribute has properties which can cause subtle convergence problems in BGP. These properties and problems have proven to be hard to understand, at least historically, and may still not be widely understood. The following attempts to collect together and present what is known about MED, to help operators and FRR users in designing and configuring their networks.

The BGP MED attribute is intended to allow one AS to indicate its preferences for its ingress points to another AS. The MED attribute will not be propagated on to another AS by the receiving AS - it is 'non-transitive' in the BGP sense.

E.g., if AS X and AS Y have 2 different BGP peering points, then AS X might set a MED of 100 on routes advertised at one and a MED of 200 at the other. When AS Y selects between otherwise equal routes to or via AS X, AS Y should prefer to take the path via the lower MED peering of 100 with AS X. Setting the MED allows an AS to influence the routing taken to it within another, neighbouring AS.

In this use of MED it is not really meaningful to compare the MED value on routes where the next AS on the paths differs. E.g., if AS Y also had a route for some destination via AS Z in addition to the routes from AS X, and AS Z had also set a MED, it wouldn't make sense for AS Y to compare AS Z's MED values to those of AS X. The MED values have been set by different administrators, with different frames of reference.

The default behaviour of BGP therefore is to not compare MED values across routes received from different neighbouring ASes. In FRR this is done by comparing the neighbouring, left-most AS in the received AS\_PATHs of the routes and only comparing MED if those are the same.

Unfortunately, this behaviour of MED, of sometimes being compared across routes and sometimes not, depending on the properties of those other routes, means MED can cause the order of preference over all the routes to be undefined. That is, given routes A, B, and C, if A is preferred to B, and B is preferred to C, then a well-defined order should mean the preference is transitive (in the sense of orders<sup>1</sup>) and that A would be preferred to C.

However, when MED is involved this need not be the case. With MED it is possible that C is actually preferred over A. So A is preferred to B, B is preferred to C, but C is preferred to A. This can be true even where BGP defines a deterministic 'most preferred' route out of the full set of A,B,C. With MED, for any given set of routes there may be a deterministically preferred route, but there need not be any way to arrange them into any order of preference. With unmodified MED, the order of preference of routes literally becomes undefined.

That MED can induce non-transitive preferences over routes can cause issues. Firstly, it may be perceived to cause routing table churn locally at speakers; secondly, and more seriously, it may cause routing instability in iBGP topologies, where sets of speakers continually oscillate between different paths.

The first issue arises from how speakers often implement routing decisions. Though BGP defines a selection process that will deterministically select the same route as best at any given speaker, even with MED, that process requires evaluating all routes together. For performance and ease of implementation reasons, many implementations evaluate route preferences in a pair-wise fashion instead. Given there is no well-defined order when MED is involved, the best route that will be chosen becomes subject to implementation details, such as the order the routes are stored in. That may be (locally) non-deterministic, e.g.: it may be the order the routes were received in.

---

<sup>1</sup> For some set of objects to have an order, there *must* be some binary ordering relation that is defined for *every* combination of those objects, and that relation *must* be transitive. I.e., if the relation operator is <, and if a < b and b < c then that relation must carry over and it *must* be that a < c for the objects to have an order. The ordering relation may allow for equality, i.e. a < b and b < a may both be true and imply that a and b are equal in the order and not distinguished by it, in which case the set has a partial order. Otherwise, if there is an order, all the objects have a distinct place in the order and the set has a total order)



This indeterminism may be considered undesirable, though it need not cause problems. It may mean additional routing churn is perceived, as sometimes more updates may be produced than at other times in reaction to some event .

This first issue can be fixed with a more deterministic route selection that ensures routes are ordered by the neighbouring AS during selection. *bgp deterministic-med*. This may reduce the number of updates as routes are received, and may in some cases reduce routing churn. Though, it could equally deterministically produce the largest possible set of updates in response to the most common sequence of received updates.

A deterministic order of evaluation tends to imply an additional overhead of sorting over any set of n routes to a destination. The implementation of deterministic MED in FRR scales significantly worse than most sorting algorithms at present, with the number of paths to a given destination. That number is often low enough to not cause any issues, but where there are many paths, the deterministic comparison may quickly become increasingly expensive in terms of CPU.

Deterministic local evaluation can *not* fix the second, more major, issue of MED however. Which is that the non-transitive preference of routes MED can cause may lead to routing instability or oscillation across multiple speakers in iBGP topologies. This can occur with full-mesh iBGP, but is particularly problematic in non-full-mesh iBGP topologies that further reduce the routing information known to each speaker. This has primarily been documented with iBGP *route-reflection* topologies. However, any route-hiding technologies potentially could also exacerbate oscillation with MED.

This second issue occurs where speakers each have only a subset of routes, and there are cycles in the preferences between different combinations of routes - as the undefined order of preference of MED allows - and the routes are distributed in a way that causes the BGP speakers to ‘chase’ those cycles. This can occur even if all speakers use a deterministic order of evaluation in route selection.

E.g., speaker 4 in AS A might receive a route from speaker 2 in AS X, and from speaker 3 in AS Y; while speaker 5 in AS A might receive that route from speaker 1 in AS Y. AS Y might set a MED of 200 at speaker 1, and 100 at speaker 3. I.e, using ASN:ID:MED to label the speakers:

```

.
  /-----\\
X:2-----|--A:4-----A:5--|-Y:1:200
          Y:3:100--|-/   |
  \\-----/

```

Assuming all other metrics are equal (AS\_PATH, ORIGIN, 0 IGP costs), then based on the RFC4271 decision process speaker 4 will choose X:2 over Y:3:100, based on the lower ID of 2. Speaker 4 advertises X:2 to speaker 5. Speaker 5 will continue to prefer Y:1:200 based on the ID, and advertise this to speaker 4. Speaker 4 will now have the full set of routes, and the Y:1:200 it receives from 5 will beat X:2, but when speaker 4 compares Y:1:200 to Y:3:100 the MED check now becomes active as the ASes match, and now Y:3:100 is preferred. Speaker 4 therefore now advertises Y:3:100 to 5, which will also agree that Y:3:100 is preferred to Y:1:200, and so withdraws the latter route from 4. Speaker 4 now has only X:2 and Y:3:100, and X:2 beats Y:3:100, and so speaker 4 implicitly updates its route to speaker 5 to X:2. Speaker 5 sees that Y:1:200 beats X:2 based on the ID, and advertises Y:1:200 to speaker 4, and the cycle continues.

The root cause is the lack of a clear order of preference caused by how MED sometimes is and sometimes is not compared, leading to this cycle in the preferences between the routes:

```

.
/----> X:2 ---beats----> Y:3:100 --\\
|
|
\\---beats--- Y:1:200 <---beats---/

```

This particular type of oscillation in full-mesh iBGP topologies can be avoided by speakers preferring already selected, external routes rather than choosing to update to new a route based on a post-MED metric (e.g. router-ID), at the cost

of a non-deterministic selection process. FRR implements this, as do many other implementations, so long as it is not overridden by setting `bgp bestpath compare-routerid`, and see also *Route Selection*.

However, more complex and insidious cycles of oscillation are possible with iBGP route-reflection, which are not so easily avoided. These have been documented in various places. See, e.g.:

- [bgp-route-osci-cond]
- [stable-flexible-ibgp]
- [ibgp-correctness]

for concrete examples and further references.

There is as of this writing *no* known way to use MED for its original purpose; *and* reduce routing information in iBGP topologies; *and* be sure to avoid the instability problems of MED due the non-transitive routing preferences it can induce; in general on arbitrary networks.

There may be iBGP topology specific ways to reduce the instability risks, even while using MED, e.g.: by constraining the reflection topology and by tuning IGP costs between route-reflector clusters, see [RFC 3345](#) for details. In the near future, the Add-Path extension to BGP may also solve MED oscillation while still allowing MED to be used as intended, by distributing “best-paths per neighbour AS”. This would be at the cost of distributing at least as many routes to all speakers as a full-mesh iBGP would, if not more, while also imposing similar CPU overheads as the “Deterministic MED” feature at each Add-Path reflector.

More generally, the instability problems that MED can introduce on more complex, non-full-mesh, iBGP topologies may be avoided either by:

- Setting `bgp always-compare-med`, however this allows MED to be compared across values set by different neighbour ASes, which may not produce coherent desirable results, of itself.
- Effectively ignoring MED by setting MED to the same value (e.g.: 0) using `set metric METRIC` on all received routes, in combination with setting `bgp always-compare-med` on all speakers. This is the simplest and most performant way to avoid MED oscillation issues, where an AS is happy not to allow neighbours to inject this problematic metric.

As MED is evaluated after the AS\_PATH length check, another possible use for MED is for intra-AS steering of routes with equal AS\_PATH length, as an extension of the last case above. As MED is evaluated before IGP metric, this can allow cold-potato routing to be implemented to send traffic to preferred hand-offs with neighbours, rather than the closest hand-off according to the IGP metric.

Note that even if action is taken to address the MED non-transitivity issues, other oscillations may still be possible. E.g., on IGP cost if iBGP and IGP topologies are at cross-purposes with each other - see the Flavel and Roughan paper above for an example. Hence the guideline that the iBGP topology should follow the IGP topology.

### **bgp deterministic-med**

Carry out route-selection in way that produces deterministic answers locally, even in the face of MED and the lack of a well-defined order of preference it can induce on routes. Without this option the preferred route with MED may be determined largely by the order that routes were received in.

Setting this option will have a performance cost that may be noticeable when there are many routes for each destination. Currently in FRR it is implemented in a way that scales poorly as the number of routes per destination increases.

The default is that this option is not set.

Note that there are other sources of indeterminism in the route selection process, specifically, the preference for older and already selected routes from eBGP peers, *Route Selection*.

### **bgp always-compare-med**

Always compare the MED on routes, even when they were received from different neighbouring ASes. Setting this option makes the order of preference of routes more defined, and should eliminate MED induced oscillations.

If using this option, it may also be desirable to use `set metric METRIC` to set MED to 0 on routes received from external neighbours.

This option can be used, together with `set metric METRIC` to use MED as an intra-AS metric to steer equal-length AS\_PATH routes to, e.g., desired exit points.

## Graceful Restart

BGP graceful restart functionality as defined in [RFC-4724](#) defines the mechanisms that allows BGP speaker to continue to forward data packets along known routes while the routing protocol information is being restored.

Usually, when BGP on a router restarts, all the BGP peers detect that the session went down and then came up. This “down/up” transition results in a “routing flap” and causes BGP route re-computation, generation of BGP routing updates, and unnecessary churn to the forwarding tables.

The following functionality is provided by graceful restart:

1. The feature allows the restarting router to indicate to the helping peer the routes it can preserve in its forwarding plane during control plane restart by sending graceful restart capability in the OPEN message sent during session establishment.
2. The feature allows helping router to advertise to all other peers the routes received from the restarting router which are preserved in the forwarding plane of the restarting router during control plane restart.

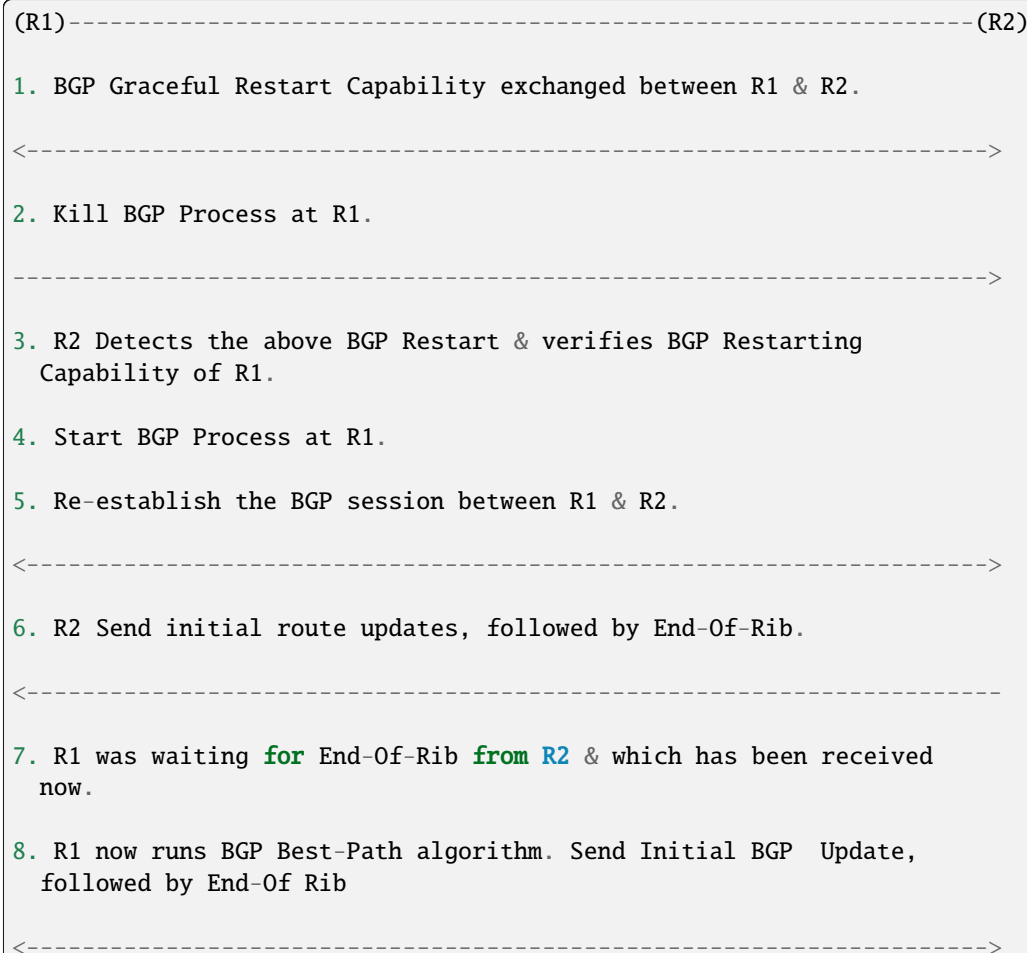

## End-of-RIB (EOR) message

An UPDATE message with no reachable Network Layer Reachability Information (NLRI) and empty withdrawn NLRI is specified as the End-of-RIB marker that can be used by a BGP speaker to indicate to its peer the completion of the initial routing update after the session is established.

For the IPv4 unicast address family, the End-of-RIB marker is an UPDATE message with the minimum length. For any other address family, it is an UPDATE message that contains only the MP\_UNREACH\_NLRI attribute with no withdrawn routes for that <AFI, SAFI>.

Although the End-of-RIB marker is specified for the purpose of BGP graceful restart, it is noted that the generation of such a marker upon completion of the initial update would be useful for routing convergence in general, and thus the practice is recommended.

## Route Selection Deferral Timer

Specifies the time the restarting router defers the route selection process after restart.

Restarting Router : The usage of route election deferral timer is specified in <https://tools.ietf.org/html/rfc4724#section-4.1>

Once the session between the Restarting Speaker and the Receiving Speaker is re-established, the Restarting Speaker will receive and process BGP messages from its peers.

However, it MUST defer route selection for an address family until it either.

1. Receives the End-of-RIB marker from all its peers (excluding the ones with the “Restart State” bit set in the received capability and excluding the ones that do not advertise the graceful restart capability).
2. The Selection\_Deferral\_Timer timeout.

### **bgp graceful-restart select-defer-time (0-3600)**

This is command, will set deferral time to value specified.

### **bgp graceful-restart rib-stale-time (1-3600)**

This is command, will set the time for which stale routes are kept in RIB.

## BGP Per Peer Graceful Restart

Ability to enable and disable graceful restart, helper and no GR at all mode functionality at peer level.

So bgp graceful restart can be enabled at modes global BGP level or at per peer level. There are two FSM, one for BGP GR global mode and other for peer per GR.

Default global mode is helper and default peer per mode is inherit from global. If per peer mode is configured, the GR mode of this particular peer will override the global mode.

## BGP GR Global Mode Commands

### **bgp graceful-restart**

This command will enable BGP graceful restart ifunctionality at the global level.

### **bgp graceful-restart disable**

This command will disable both the functionality graceful restart and helper mode.

## BGP GR Peer Mode Commands

### **neighbor A.B.C.D graceful-restart**

This command will enable BGP graceful restart ifunctionality at the peer level.

### **neighbor A.B.C.D graceful-restart-helper**

This command will enable BGP graceful restart helper only functionality at the peer level.

### **neighbor A.B.C.D graceful-restart-disable**

This command will disable the entire BGP graceful restart functionality at the peer level.

## Administrative Shutdown

### **[no] bgp shutdown [message MSG...]**

Administrative shutdown of all peers of a bgp instance. Drop all BGP peers, but preserve their configurations. The peers are notified in accordance with RFC 8203 by sending a NOTIFICATION message with error code Cease and subcode Administrative Shutdown prior to terminating connections. This global shutdown is independent of the neighbor shutdown, meaning that individually shut down peers will not be affected by lifting it.

An optional shutdown message *MSG* can be specified.

## Networks

### **network A.B.C.D/M**

This command adds the announcement network.

```
router bgp 1
address-family ipv4 unicast
network 10.0.0.0/8
exit-address-family
```

This configuration example says that network 10.0.0.0/8 will be announced to all neighbors. Some vendors' routers don't advertise routes if they aren't present in their IGP routing tables; *bgpd* doesn't care about IGP routes when announcing its routes.

### **no network A.B.C.D/M**

### **[no] bgp network import-check**

This configuration modifies the behavior of the network statement. If you have this configured the underlying network must exist in the rib. If you have the [no] form configured then BGP will not check for the networks existence in the rib. default is the network must exist.

## IPv6 Support

### [no] neighbor X:X::X:X activate

This configuration modifies whether to enable an address family for a specific neighbor. By default only the IPv4 unicast address family is enabled.

```
router bgp 1
address-family ipv6 unicast
neighbor 2001:0DB8::1 activate
network 2001:0DB8:5009::/64
exit-address-family
```

This configuration example says that network 2001:0DB8:5009::/64 will be announced and enables the neighbor 2001:0DB8::1 to receive this announcement.

### [no] bgp default ipv4-unicast

By default, only the IPv4 unicast address family is announced to all neighbors. Using the ‘no bgp default ipv4-unicast’ configuration overrides this default so that all address families need to be enabled explicitly.

```
router bgp 1
no bgp default ipv4-unicast
neighbor 10.10.10.1 remote-as 2
neighbor 2001:0DB8::1 remote-as 3
address-family ipv4 unicast
neighbor 10.10.10.1 activate
network 192.168.1.0/24
exit-address-family
address-family ipv6 unicast
neighbor 2001:0DB8::1 activate
network 2001:0DB8:5009::/64
exit-address-family
```

This configuration demonstrates how the ‘no bgp default ipv4-unicast’ might be used in a setup with two upstreams where each of the upstreams should only receive either IPv4 or IPv6 announcements.

## Route Aggregation

### Route Aggregation-IPv4 Address Family

#### aggregate-address A.B.C.D/M

This command specifies an aggregate address.

#### aggregate-address A.B.C.D/M route-map NAME

Apply a route-map for an aggregated prefix.

#### aggregate-address A.B.C.D/M origin <egp|igp|incomplete>

Override ORIGIN for an aggregated prefix.

#### aggregate-address A.B.C.D/M as-set

This command specifies an aggregate address. Resulting routes include AS set.

#### aggregate-address A.B.C.D/M summary-only

This command specifies an aggregate address. Aggregated routes will not be announced.

**no aggregate-address A.B.C.D/M**

This command removes an aggregate address.

This configuration example setup the aggregate-address under ipv4 address-family.

```
router bgp 1
address-family ipv4 unicast
aggregate-address 10.0.0.0/8
aggregate-address 20.0.0.0/8 as-set
aggregate-address 40.0.0.0/8 summary-only
aggregate-address 50.0.0.0/8 route-map aggr-rmap
exit-address-family
```

**Route Aggregation-IPv6 Address Family****aggregate-address X:X::X:X/M**

This command specifies an aggregate address.

**aggregate-address X:X::X:X/M route-map NAME**

Apply a route-map for an aggregated prefix.

**aggregate-address X:X::X:X/M origin <egp|igp|incomplete>**

Override ORIGIN for an aggregated prefix.

**aggregate-address X:X::X:X/M as-set**

This command specifies an aggregate address. Resulting routes include AS set.

**aggregate-address X:X::X:X/M summary-only**

This command specifies an aggregate address. Aggregated routes will not be announced.

**no aggregate-address X:X::X:X/M**

This command removes an aggregate address.

This configuration example setup the aggregate-address under ipv6 address-family.

```
router bgp 1
address-family ipv6 unicast
aggregate-address 10::0/64
aggregate-address 20::0/64 as-set
aggregate-address 40::0/64 summary-only
aggregate-address 50::0/64 route-map aggr-rmap
exit-address-family
```

**Redistribution****redistribute kernel**

Redistribute kernel route to BGP process.

**redistribute static**

Redistribute static route to BGP process.

**redistribute connected**

Redistribute connected route to BGP process.

**redistribute rip**

Redistribute RIP route to BGP process.

**redistribute ospf**

Redistribute OSPF route to BGP process.

**redistribute vnc**

**bgp update-delay MAX-DELAY ESTABLISH-WAIT**

This feature is used to enable read-only mode on BGP process restart or when a BGP process is cleared using 'clear ip bgp \*'. Note that this command is configured at the global level and applies to all bgp instances/vrfs. It cannot be used at the same time as the "update-delay" command described below, which is entered in each bgp instance/vrf desired to delay update installation and advertisements. The global and per-vrf approaches to defining update-delay are mutually exclusive.

When applicable, read-only mode would begin as soon as the first peer reaches Established status and a timer for max-delay seconds is started. During this mode BGP doesn't run any best-path or generate any updates to its peers. This mode continues until:

1. All the configured peers, except the shutdown peers, have sent explicit EOR (End-Of-RIB) or an implicit-EOR. The first keep-alive after BGP has reached Established is considered an implicit-EOR. If the establish-wait optional value is given, then BGP will wait for peers to reach established from the beginning of the update-delay till the establish-wait period is over, i.e. the minimum set of established peers for which EOR is expected would be peers established during the establish-wait window, not necessarily all the configured neighbors.
2. max-delay period is over.

On hitting any of the above two conditions, BGP resumes the decision process and generates updates to its peers.

Default max-delay is 0, i.e. the feature is off by default.

**update-delay MAX-DELAY**

**update-delay MAX-DELAY ESTABLISH-WAIT**

This feature is used to enable read-only mode on BGP process restart or when a BGP process is cleared using 'clear ip bgp \*'. Note that this command is configured under the specific bgp instance/vrf that the feature is enabled for. It cannot be used at the same time as the global "bgp update-delay" described above, which is entered at the global level and applies to all bgp instances. The global and per-vrf approaches to defining update-delay are mutually exclusive.

When applicable, read-only mode would begin as soon as the first peer reaches Established status and a timer for max-delay seconds is started. During this mode BGP doesn't run any best-path or generate any updates to its peers. This mode continues until:

1. All the configured peers, except the shutdown peers, have sent explicit EOR (End-Of-RIB) or an implicit-EOR. The first keep-alive after BGP has reached Established is considered an implicit-EOR. If the establish-wait optional value is given, then BGP will wait for peers to reach established from the beginning of the update-delay till the establish-wait period is over, i.e. the minimum set of established peers for which EOR is expected would be peers established during the establish-wait window, not necessarily all the configured neighbors.
2. max-delay period is over.

On hitting any of the above two conditions, BGP resumes the decision process and generates updates to its peers.

Default max-delay is 0, i.e. the feature is off by default.



**table-map ROUTE-MAP-NAME**

This feature is used to apply a route-map on route updates from BGP to Zebra. All the applicable match operations are allowed, such as match on prefix, next-hop, communities, etc. Set operations for this attach-point are limited to metric and next-hop only. Any operation of this feature does not affect BGP's internal RIB.

Supported for ipv4 and ipv6 address families. It works on multi-paths as well, however, metric setting is based on the best-path only.

**Peers****Defining Peers****neighbor PEER remote-as ASN**

Creates a new neighbor whose remote-as is ASN. PEER can be an IPv4 address or an IPv6 address or an interface to use for the connection.

```
router bgp 1
neighbor 10.0.0.1 remote-as 2
```

In this case my router, in AS-1, is trying to peer with AS-2 at 10.0.0.1.

This command must be the first command used when configuring a neighbor. If the remote-as is not specified, *bgpd* will complain like this:

```
can't find neighbor 10.0.0.1
```

**neighbor PEER remote-as internal**

Create a peer as you would when you specify an ASN, except that if the peers ASN is different than mine as specified under the *router bgp ASN* command the connection will be denied.

**neighbor PEER remote-as external**

Create a peer as you would when you specify an ASN, except that if the peers ASN is the same as mine as specified under the *router bgp ASN* command the connection will be denied.

**[no] bgp listen range <A.B.C.D/M|X:X::X:X/M> peer-group PNAME**

Accept connections from any peers in the specified prefix. Configuration from the specified peer-group is used to configure these peers.

---

**Note:** When using BGP listen ranges, if the associated peer group has TCP MD5 authentication configured, your kernel must support this on prefixes. On Linux, this support was added in kernel version 4.14. If your kernel does not support this feature you will get a warning in the log file, and the listen range will only accept connections from peers without MD5 configured.

Additionally, we have observed that when using this option at scale (several hundred peers) the kernel may hit its option memory limit. In this situation you will see error messages like:

```
bgpd: sockopt_tcp_signature: setsockopt(23): Cannot allocate memory
```

In this case you need to increase the value of the `sysctl net.core.optmem_max` to allow the kernel to allocate the necessary option memory.

**[no] coalesce-time (0-4294967295)**

The time in milliseconds that BGP will delay before deciding what peers can be put into an update-group together in order to generate a single update for them. The default time is 1000.

## Configuring Peers

**[no] neighbor PEER shutdown [message MSG...] [rtt (1-65535) [count (1-255)]]**

Shutdown the peer. We can delete the neighbor's configuration by `no neighbor PEER remote-as ASN` but all configuration of the neighbor will be deleted. When you want to preserve the configuration, but want to drop the BGP peer, use this syntax.

Optionally you can specify a shutdown message *MSG*.

Also, you can specify optionally `_rtt_` in milliseconds to automatically shutdown the peer if round-trip-time becomes higher than defined.

Additional `_count_` parameter is the number of keepalive messages to count before shutdown the peer if round-trip-time becomes higher than defined.

**[no] neighbor PEER disable-connected-check**

Allow peerings between directly connected eBGP peers using loopback addresses.

**[no] neighbor PEER ebgp-multihop**

Specifying `ebgp-multihop` allows sessions with eBGP neighbors to establish when they are multiple hops away. When the neighbor is not directly connected and this knob is not enabled, the session will not establish.

**[no] neighbor PEER description ...**

Set description of the peer.

**[no] neighbor PEER version VERSION**

Set up the neighbor's BGP version. *version* can be *4*, *4+* or *4-*. BGP version *4* is the default value used for BGP peering. BGP version *4+* means that the neighbor supports Multiprotocol Extensions for BGP-4. BGP version *4-* is similar but the neighbor speaks the old Internet-Draft revision 00's Multiprotocol Extensions for BGP-4. Some routing software is still using this version.

**[no] neighbor PEER interface IFNAME**

When you connect to a BGP peer over an IPv6 link-local address, you have to specify the *IFNAME* of the interface used for the connection. To specify IPv4 session addresses, see the `neighbor PEER update-source` command below.

This command is deprecated and may be removed in a future release. Its use should be avoided.

**[no] neighbor PEER next-hop-self [all]**

This command specifies an announced route's nexthop as being equivalent to the address of the `bgp` router if it is learned via eBGP. If the optional keyword *all* is specified the modification is done also for routes learned via iBGP.

**neighbor PEER attribute-unchanged [{as-path|next-hop|med}]**

This command specifies attributes to be left unchanged for advertisements sent to a peer. Use this to leave the next-hop unchanged in ipv6 configurations, as the route-map directive to leave the next-hop unchanged is only available for ipv4.

**[no] neighbor PEER update-source <IFNAME|ADDRESS>**

Specify the IPv4 source address to use for the BGP session to this neighbour, may be specified as either an IPv4 address directly or as an interface name (in which case the *zebra* daemon MUST be running in order for *bgpd* to be able to retrieve interface state).

```
router bgp 64555
neighbor foo update-source 192.168.0.1
neighbor bar update-source loopback0
```

**[no] neighbor PEER default-originate**

*bgpd*'s default is to not announce the default route (0.0.0.0/0) even if it is in routing table. When you want to announce default routes to the peer, use this command.

**neighbor PEER port PORT****[no] neighbor PEER password PASSWORD**

Set a MD5 password to be used with the tcp socket that is being used to connect to the remote peer. Please note if you are using this command with a large number of peers on linux you should consider modifying the *net.core.optmem\_max* sysctl to a larger value to avoid out of memory errors from the linux kernel.

**neighbor PEER send-community****[no] neighbor PEER weight WEIGHT**

This command specifies a default *weight* value for the neighbor's routes.

**[no] neighbor PEER maximum-prefix NUMBER [force]**

Sets a maximum number of prefixes we can receive from a given peer. If this number is exceeded, the BGP session will be destroyed.

In practice, it is generally preferable to use a prefix-list to limit what prefixes are received from the peer instead of using this knob. Tearing down the BGP session when a limit is exceeded is far more destructive than merely rejecting undesired prefixes. The prefix-list method is also much more granular and offers much smarter matching criterion than number of received prefixes, making it more suited to implementing policy.

If *\_force\_* is set, then ALL prefixes are counted for maximum instead of accepted only. This is useful for cases where an inbound filter is applied, but you want maximum-prefix to act on ALL (including filtered) prefixes. This option requires *soft-reconfiguration inbound* to be enabled for the peer.

**[no] neighbor PEER maximum-prefix-out NUMBER**

Sets a maximum number of prefixes we can send to a given peer.

Since sent prefix count is managed by update-groups, this option creates a separate update-group for outgoing updates.

**[no] neighbor PEER local-as AS-NUMBER [no-prepend] [replace-as]**

Specify an alternate AS for this BGP process when interacting with the specified peer. With no modifiers, the specified local-as is prepended to the received AS\_PATH when receiving routing updates from the peer, and prepended to the outgoing AS\_PATH (after the process local AS) when transmitting local routes to the peer.

If the no-prepend attribute is specified, then the supplied local-as is not prepended to the received AS\_PATH.

If the replace-as attribute is specified, then only the supplied local-as is prepended to the AS\_PATH when transmitting local-route updates to this peer.

Note that replace-as can only be specified if no-prepend is.

This command is only allowed for eBGP peers.

**[no] neighbor <A.B.C.D|X:X::X:X|WORD> as-override**

Override AS number of the originating router with the local AS number.

Usually this configuration is used in PEs (Provider Edge) to replace the incoming customer AS number so the connected CE (Customer Edge) can use the same AS number as the other customer sites. This allows customers of the provider network to use the same AS number across their sites.

This command is only allowed for eBGP peers.

**[no] neighbor <A.B.C.D|X:X::X:X|WORD> allowas-in [<(1-10)|origin>]**

Accept incoming routes with AS path containing AS number with the same value as the current system AS.

This is used when you want to use the same AS number in your sites, but you can't connect them directly. This is an alternative to *neighbor WORD as-override*.

The parameter *(1-10)* configures the amount of accepted occurrences of the system AS number in AS path.

The parameter *origin* configures BGP to only accept routes originated with the same AS number as the system.

This command is only allowed for eBGP peers.

**[no] neighbor <A.B.C.D|X:X::X:X|WORD> addpath-tx-all-paths**

Configure BGP to send all known paths to neighbor in order to preserve multi path capabilities inside a network.

**[no] neighbor <A.B.C.D|X:X::X:X|WORD> addpath-tx-bestpath-per-AS**

Configure BGP to send best known paths to neighbor in order to preserve multi path capabilities inside a network.

**[no] neighbor PEER ttl-security hops NUMBER**

This command enforces Generalized TTL Security Mechanism (GTSM), as specified in RFC 5082. With this command, only neighbors that are the specified number of hops away will be allowed to become neighbors. This command is mutually exclusive with *ebgp-multihop*.

**[no] neighbor PEER capability extended-nexthop**

Allow bgp to negotiate the extended-nexthop capability with its peer. If you are peering over a v6 LL address then this capability is turned on automatically. If you are peering over a v6 Global Address then turning on this command will allow BGP to install v4 routes with v6 nexthops if you do not have v4 configured on interfaces.

**[no] bgp fast-external-failover**

This command causes bgp to not take down ebgp peers immediately when a link flaps. *bgp fast-external-failover* is the default and will not be displayed as part of a *show run*. The no form of the command turns off this ability.

**[no] bgp default ipv4-unicast**

This command allows the user to specify that v4 peering is turned on by default or not. This command defaults to on and is not displayed. The *no bgp default ipv4-unicast* form of the command is displayed.

**[no] bgp default show-hostname**

This command shows the hostname of the peer in certain BGP commands outputs. It's easier to troubleshoot if you have a number of BGP peers.

**[no] bgp default show-nexthop-hostname**

This command shows the hostname of the next-hop in certain BGP commands outputs. It's easier to troubleshoot if you have a number of BGP peers and a number of routes to check.

**[no] neighbor PEER advertisement-interval (0-600)**

Setup the minimum route advertisement interval(mrai) for the peer in question. This number is between 0 and 600 seconds, with the default advertisement interval being 0.

## Displaying Information about Peers

**show bgp <afi> <safi> neighbors WORD bestpath-routes [json] [wide]**

For the given neighbor, WORD, that is specified list the routes selected by BGP as having the best path.

## Peer Filtering

**neighbor PEER distribute-list NAME [in|out]**

This command specifies a distribute-list for the peer. *direct* is *in* or *out*.

**neighbor PEER prefix-list NAME [in|out]**

**neighbor PEER filter-list NAME [in|out]**

**neighbor PEER route-map NAME [in|out]**

Apply a route-map on the neighbor. *direct* must be *in* or *out*.

**bgp route-reflector allow-outbound-policy**

By default, attribute modification via route-map policy out is not reflected on reflected routes. This option allows the modifications to be reflected as well. Once enabled, it affects all reflected routes.

**[no] neighbor PEER sender-as-path-loop-detection**

Enable the detection of sender side AS path loops and filter the bad routes before they are sent.

This setting is disabled by default.

## Peer Groups

Peer groups are used to help improve scaling by generating the same update information to all members of a peer group. Note that this means that the routes generated by a member of a peer group will be sent back to that originating peer with the originator identifier attribute set to indicated the originating peer. All peers not associated with a specific peer group are treated as belonging to a default peer group, and will share updates.

**neighbor WORD peer-group**

This command defines a new peer group.

**neighbor PEER peer-group PNAME**

This command bind specific peer to peer group WORD.

**neighbor PEER solo**

This command is used to indicate that routes advertised by the peer should not be reflected back to the peer. This command only is only meaningful when there is a single peer defined in the peer-group.

## Capability Negotiation

**neighbor PEER strict-capability-match**

**no neighbor PEER strict-capability-match**

Strictly compares remote capabilities and local capabilities. If capabilities are different, send Unsupported Capability error then reset connection.

You may want to disable sending Capability Negotiation OPEN message optional parameter to the peer when remote peer does not implement Capability Negotiation. Please use *dont-capability-negotiate* command to disable the feature.

**[no] neighbor PEER dont-capability-negotiate**

Suppress sending Capability Negotiation as OPEN message optional parameter to the peer. This command only affects the peer is configured other than IPv4 unicast configuration.

When remote peer does not have capability negotiation feature, remote peer will not send any capabilities at all. In that case, bgp configures the peer with configured capabilities.

You may prefer locally configured capabilities more than the negotiated capabilities even though remote peer sends capabilities. If the peer is configured by *override-capability*, *bgpd* ignores received capabilities then override negotiated capabilities with configured values.

Additionally the operator should be reminded that this feature fundamentally disables the ability to use widely deployed BGP features. BGP unnumbered, hostname support, AS4, Addpath, Route Refresh, ORF, Dynamic Capabilities, and graceful restart.

**neighbor PEER override-capability**

**no neighbor PEER override-capability**

Override the result of Capability Negotiation with local configuration. Ignore remote peer's capability value.

### AS Path Access Lists

AS path access list is user defined AS path.

**bgp as-path access-list WORD permit|deny LINE**

This command defines a new AS path access list.

**no bgp as-path access-list WORD**

**no bgp as-path access-list WORD permit|deny LINE**

### Bogon ASN filter policy configuration example

```
bgp as-path access-list 99 permit _0_  
bgp as-path access-list 99 permit _23456_  
bgp as-path access-list 99 permit _1310[0-6][0-9]_|_13107[0-1]_
```

### Using AS Path in Route Map

**[no] match as-path WORD**

For a given as-path, WORD, match it on the BGP as-path given for the prefix and if it matches do normal route-map actions. The no form of the command removes this match from the route-map.

**[no] set as-path prepend AS-PATH**

Prepend the given string of AS numbers to the AS\_PATH of the BGP path's NLRI. The no form of this command removes this set operation from the route-map.

**[no] set as-path prepend last-as NUM**

Prepend the existing last AS number (the leftmost ASN) to the AS\_PATH. The no form of this command removes this set operation from the route-map.

## Communities Attribute

The BGP communities attribute is widely used for implementing policy routing. Network operators can manipulate BGP communities attribute based on their network policy. BGP communities attribute is defined in [RFC 1997](#) and [RFC 1998](#). It is an optional transitive attribute, therefore local policy can travel through different autonomous system.

The communities attribute is a set of communities values. Each community value is 4 octet long. The following format is used to define the community value.

### AS:VAL

This format represents 4 octet communities value. AS is high order 2 octet in digit format. VAL is low order 2 octet in digit format. This format is useful to define AS oriented policy value. For example, 7675:80 can be used when AS 7675 wants to pass local policy value 80 to neighboring peer.

### internet

internet represents well-known communities value 0.

### graceful-shutdown

graceful-shutdown represents well-known communities value GRACEFUL\_SHUTDOWN 0xFFFF0000 65535:0. [RFC 8326](#) implements the purpose Graceful BGP Session Shutdown to reduce the amount of lost traffic when taking BGP sessions down for maintenance. The use of the community needs to be supported from your peers side to actually have any effect.

### accept-own

accept-own represents well-known communities value ACCEPT\_OWN 0xFFFF0001 65535:1. [RFC 7611](#) implements a way to signal to a router to accept routes with a local nexthop address. This can be the case when doing policing and having traffic having a nexthop located in another VRF but still local interface to the router. It is recommended to read the RFC for full details.

### route-filter-translated-v4

route-filter-translated-v4 represents well-known communities value ROUTE\_FILTER\_TRANSLATED\_v4 0xFFFF0002 65535:2.

### route-filter-v4

route-filter-v4 represents well-known communities value ROUTE\_FILTER\_v4 0xFFFF0003 65535:3.

### route-filter-translated-v6

route-filter-translated-v6 represents well-known communities value ROUTE\_FILTER\_TRANSLATED\_v6 0xFFFF0004 65535:4.

### route-filter-v6

route-filter-v6 represents well-known communities value ROUTE\_FILTER\_v6 0xFFFF0005 65535:5.

### llgr-stale

llgr-stale represents well-known communities value LLGR\_STALE 0xFFFF0006 65535:6. Assigned and intended only for use with routers supporting the Long-lived Graceful Restart Capability as described in [\[Draft-IETF-uttaro-idr-bgp-persistence\]](#). Routers receiving routes with this community may (depending on implementation) choose allow to reject or modify routes on the presence or absence of this community.

### no-llgr

no-llgr represents well-known communities value NO\_LLGR 0xFFFF0007 65535:7. Assigned and intended only for use with routers supporting the Long-lived Graceful Restart Capability as described in [\[Draft-IETF-uttaro-idr-bgp-persistence\]](#). Routers receiving routes with this community may (depending on implementation) choose allow to reject or modify routes on the presence or absence of this community.

### accept-own-nexthop

accept-own-nexthop represents well-known communities value accept-own-nexthop 0xFFFF0008 65535:8. [\[Draft-IETF-agrewal-idr-accept-own-nexthop\]](#) describes how to tag and label VPN routes to be able to send traffic between VRFs via an internal layer 2 domain on the same PE device. Refer to [\[Draft-IETF-agrewal-idr-accept-own-nexthop\]](#) for full details.

### **blackhole**

**blackhole** represents well-known communities value `BLACKHOLE 0xFFFF029A 65535:666`. [RFC 7999](#) documents sending prefixes to EBGp peers and upstream for the purpose of blackholing traffic. Prefixes tagged with the this community should normally not be re-advertised from neighbors of the originating network. It is recommended upon receiving prefixes tagged with this community to add `NO_EXPORT` and `NO_ADVERTISE`.

### **no-export**

**no-export** represents well-known communities value `NO_EXPORT 0xFFFFF01`. All routes carry this value must not be advertised to outside a BGP confederation boundary. If neighboring BGP peer is part of BGP confederation, the peer is considered as inside a BGP confederation boundary, so the route will be announced to the peer.

### **no-advertise**

**no-advertise** represents well-known communities value `NO_ADVERTISE 0xFFFFF02`. All routes carry this value must not be advertise to other BGP peers.

### **local-AS**

**local-AS** represents well-known communities value `NO_EXPORT_SUBCONFED 0xFFFFF03`. All routes carry this value must not be advertised to external BGP peers. Even if the neighboring router is part of confederation, it is considered as external BGP peer, so the route will not be announced to the peer.

### **no-peer**

**no-peer** represents well-known communities value `NOPEER 0xFFFFF04 65535:65284`. [RFC 3765](#) is used to communicate to another network how the originating network want the prefix propagated.

When the communities attribute is received duplicate community values in the attribute are ignored and value is sorted in numerical order.

## **Community Lists**

Community lists are user defined lists of community attribute values. These lists can be used for matching or manipulating the communities attribute in UPDATE messages.

There are two types of community list:

### **standard**

This type accepts an explicit value for the attribute.

### **expanded**

This type accepts a regular expression. Because the regex must be interpreted on each use expanded community lists are slower than standard lists.

### **bgp community-list standard NAME permit|deny COMMUNITY**

This command defines a new standard community list. `COMMUNITY` is communities value. The `COMMUNITY` is compiled into community structure. We can define multiple community list under same name. In that case match will happen user defined order. Once the community list matches to communities attribute in BGP updates it return permit or deny by the community list definition. When there is no matched entry, deny will be returned. When `COMMUNITY` is empty it matches to any routes.

### **bgp community-list expanded NAME permit|deny COMMUNITY**

This command defines a new expanded community list. `COMMUNITY` is a string expression of communities attribute. `COMMUNITY` can be a regular expression (*BGP Regular Expressions*) to match the communities attribute in BGP updates. The expanded community is only used to filter, not *set* actions.

Deprecated since version 5.0: It is recommended to use the more explicit versions of this command.



**bgp community-list NAME permit|deny COMMUNITY**

When the community list type is not specified, the community list type is automatically detected. If COMMUNITY can be compiled into communities attribute, the community list is defined as a standard community list. Otherwise it is defined as an expanded community list. This feature is left for backward compatibility. Use of this feature is not recommended.

**no bgp community-list [standard|expanded] NAME**

Deletes the community list specified by NAME. All community lists share the same namespace, so it's not necessary to specify standard or expanded; these modifiers are purely aesthetic.

**show bgp community-list [NAME detail]**

Displays community list information. When NAME is specified the specified community list's information is shown.

```
# show bgp community-list
Named Community standard list CLIST
permit 7675:80 7675:100 no-export
deny internet
  Named Community expanded list EXPAND
permit :

# show bgp community-list CLIST detail
Named Community standard list CLIST
permit 7675:80 7675:100 no-export
deny internet
```

## Numbered Community Lists

When number is used for BGP community list name, the number has special meanings. Community list number in the range from 1 and 99 is standard community list. Community list number in the range from 100 to 199 is expanded community list. These community lists are called as numbered community lists. On the other hand normal community lists is called as named community lists.

**bgp community-list (1-99) permit|deny COMMUNITY**

This command defines a new community list. The argument to (1-99) defines the list identifier.

**bgp community-list (100-199) permit|deny COMMUNITY**

This command defines a new expanded community list. The argument to (100-199) defines the list identifier.

## Using Communities in Route Maps

In *Route Maps* we can match on or set the BGP communities attribute. Using this feature network operator can implement their network policy based on BGP communities attribute.

The following commands can be used in route maps:

**match community WORD exact-match [exact-match]**

This command perform match to BGP updates using community list WORD. When the one of BGP communities value match to the one of communities value in community list, it is match. When *exact-match* keyword is specified, match happen only when BGP updates have completely same communities value specified in the community list.

### **set community <none|COMMUNITY> additive**

This command sets the community value in BGP updates. If the attribute is already configured, the newly provided value replaces the old one unless the **additive** keyword is specified, in which case the new value is appended to the existing value.

If **none** is specified as the community value, the **communities** attribute is not sent.

It is not possible to set an expanded community list.

### **set comm-list WORD delete**

This command remove communities value from BGP communities attribute. The **word** is community list name. When BGP route's communities value matches to the community list **word**, the communities value is removed. When all of communities value is removed eventually, the BGP update's communities attribute is completely removed.

## Example Configuration

The following configuration is exemplary of the most typical usage of BGP communities attribute. In the example, AS 7675 provides an upstream Internet connection to AS 100. When the following configuration exists in AS 7675, the network operator of AS 100 can set local preference in AS 7675 network by setting BGP communities attribute to the updates.

```
router bgp 7675
 neighbor 192.168.0.1 remote-as 100
 address-family ipv4 unicast
  neighbor 192.168.0.1 route-map RMAP in
 exit-address-family
!
bgp community-list 70 permit 7675:70
bgp community-list 70 deny
bgp community-list 80 permit 7675:80
bgp community-list 80 deny
bgp community-list 90 permit 7675:90
bgp community-list 90 deny
!
route-map RMAP permit 10
 match community 70
 set local-preference 70
!
route-map RMAP permit 20
 match community 80
 set local-preference 80
!
route-map RMAP permit 30
 match community 90
 set local-preference 90
```

The following configuration announces 10.0.0.0/8 from AS 100 to AS 7675. The route has communities value 7675:80 so when above configuration exists in AS 7675, the announced routes' local preference value will be set to 80.

```
router bgp 100
 network 10.0.0.0/8
 neighbor 192.168.0.2 remote-as 7675
```

(continues on next page)

(continued from previous page)

```

address-family ipv4 unicast
  neighbor 192.168.0.2 route-map RMAP out
exit-address-family
!
ip prefix-list PLIST permit 10.0.0.0/8
!
route-map RMAP permit 10
  match ip address prefix-list PLIST
  set community 7675:80

```

The following configuration is an example of BGP route filtering using communities attribute. This configuration only permit BGP routes which has BGP communities value 0:80 or 0:90. The network operator can set special internal communities value at BGP border router, then limit the BGP route announcements into the internal network.

```

router bgp 7675
  neighbor 192.168.0.1 remote-as 100
  address-family ipv4 unicast
    neighbor 192.168.0.1 route-map RMAP in
  exit-address-family
!
bgp community-list 1 permit 0:80 0:90
!
route-map RMAP permit in
  match community 1

```

The following example filters BGP routes which have a community value of 1:1. When there is no match community-list returns deny. To avoid filtering all routes, a permit line is set at the end of the community-list.

```

router bgp 7675
  neighbor 192.168.0.1 remote-as 100
  address-family ipv4 unicast
    neighbor 192.168.0.1 route-map RMAP in
  exit-address-family
!
bgp community-list standard FILTER deny 1:1
bgp community-list standard FILTER permit
!
route-map RMAP permit 10
  match community FILTER

```

The communities value keyword internet has special meanings in standard community lists. In the below example internet matches all BGP routes even if the route does not have communities attribute at all. So community list INTERNET is the same as FILTER in the previous example.

```

bgp community-list standard INTERNET deny 1:1
bgp community-list standard INTERNET permit internet

```

The following configuration is an example of communities value deletion. With this configuration the community values 100:1 and 100:2 are removed from BGP updates. For communities value deletion, only permit community-list is used. deny community-list is ignored.

```

router bgp 7675
  neighbor 192.168.0.1 remote-as 100

```

(continues on next page)

```

address-family ipv4 unicast
  neighbor 192.168.0.1 route-map RMAP in
exit-address-family
!
bgp community-list standard DEL permit 100:1 100:2
!
route-map RMAP permit 10
  set comm-list DEL delete

```

## Extended Communities Attribute

BGP extended communities attribute is introduced with MPLS VPN/BGP technology. MPLS VPN/BGP expands capability of network infrastructure to provide VPN functionality. At the same time it requires a new framework for policy routing. With BGP Extended Communities Attribute we can use Route Target or Site of Origin for implementing network policy for MPLS VPN/BGP.

BGP Extended Communities Attribute is similar to BGP Communities Attribute. It is an optional transitive attribute. BGP Extended Communities Attribute can carry multiple Extended Community value. Each Extended Community value is eight octet length.

BGP Extended Communities Attribute provides an extended range compared with BGP Communities Attribute. Adding to that there is a type field in each value to provides community space structure.

There are two format to define Extended Community value. One is AS based format the other is IP address based format.

### AS:VAL

This is a format to define AS based Extended Community value. AS part is 2 octets Global Administrator subfield in Extended Community value. VAL part is 4 octets Local Administrator subfield. 7675:100 represents AS 7675 policy value 100.

### IP-Address:VAL

This is a format to define IP address based Extended Community value. IP-Address part is 4 octets Global Administrator subfield. VAL part is 2 octets Local Administrator subfield.

## Extended Community Lists

### **bgp extcommunity-list standard NAME permit|deny EXTCOMMUNITY**

This command defines a new standard extcommunity-list. *extcommunity* is extended communities value. The *extcommunity* is compiled into extended community structure. We can define multiple extcommunity-list under same name. In that case match will happen user defined order. Once the extcommunity-list matches to extended communities attribute in BGP updates it return permit or deny based upon the extcommunity-list definition. When there is no matched entry, deny will be returned. When *extcommunity* is empty it matches to any routes.

### **bgp extcommunity-list expanded NAME permit|deny LINE**

This command defines a new expanded extcommunity-list. *line* is a string expression of extended communities attribute. *line* can be a regular expression (*BGP Regular Expressions*) to match an extended communities attribute in BGP updates.

### **no bgp extcommunity-list NAME**

### **no bgp extcommunity-list standard NAME**

**no bgp extcommunity-list expanded NAME**

These commands delete extended community lists specified by *name*. All of extended community lists shares a single name space. So extended community lists can be removed simply specifying the name.

**show bgp extcommunity-list****show bgp extcommunity-list NAME detail**

This command displays current extcommunity-list information. When *name* is specified the community list's information is shown.:

```
# show bgp extcommunity-list
```

**BGP Extended Communities in Route Map****match extcommunity WORD****set extcommunity rt EXTCOMMUNITY**

This command set Route Target value.

**set extcommunity soo EXTCOMMUNITY**

This command set Site of Origin value.

**set extcommunity bandwidth <(1-25600) | cumulative | num-multipaths> [non-transitive]**

This command sets the BGP link-bandwidth extended community for the prefix (best path) for which it is applied. The link-bandwidth can be specified as an **explicit** value (specified in Mbps), or the router can be told to use the **cumulative** bandwidth of all multipaths for the prefix or to compute it based on the **number** of multipaths. The link bandwidth extended community is encoded as **transitive** unless the set command explicitly configures it as **non-transitive**.

**See also:**

wecmp\_linkbw

Note that the extended expanded community is only used for *match* rule, not for *set* actions.

**Large Communities Attribute**

The BGP Large Communities attribute was introduced in Feb 2017 with [RFC 8092](#).

The BGP Large Communities Attribute is similar to the BGP Communities Attribute except that it has 3 components instead of two and each of which are 4 octets in length. Large Communities bring additional functionality and convenience over traditional communities, specifically the fact that the GLOBAL part below is now 4 octets wide allowing seamless use in networks using 4-byte ASNs.

**GLOBAL:LOCAL1:LOCAL2**

This is the format to define Large Community values. Referencing [RFC 8195](#) the values are commonly referred to as follows:

- The GLOBAL part is a 4 octet Global Administrator field, commonly used as the operators AS number.
- The LOCAL1 part is a 4 octet Local Data Part 1 subfield referred to as a function.
- The LOCAL2 part is a 4 octet Local Data Part 2 field and referred to as the parameter subfield.

As an example, 65551:1:10 represents AS 65551 function 1 and parameter 10. The referenced RFC above gives some guidelines on recommended usage.

## Large Community Lists

Two types of large community lists are supported, namely *standard* and *expanded*.

**bgp large-community-list standard NAME permit|deny LARGE-COMMUNITY**

This command defines a new standard large-community-list. *large-community* is the Large Community value. We can add multiple large communities under same name. In that case the match will happen in the user defined order. Once the large-community-list matches the Large Communities attribute in BGP updates it will return permit or deny based upon the large-community-list definition. When there is no matched entry, a deny will be returned. When *large-community* is empty it matches any routes.

**bgp large-community-list expanded NAME permit|deny LINE**

This command defines a new expanded large-community-list. Where *line* is a string matching expression, it will be compared to the entire Large Communities attribute as a string, with each large-community in order from lowest to highest. *line* can also be a regular expression which matches this Large Community attribute.

**no bgp large-community-list NAME**

**no bgp large-community-list standard NAME**

**no bgp large-community-list expanded NAME**

These commands delete Large Community lists specified by *name*. All Large Community lists share a single namespace. This means Large Community lists can be removed by simply specifying the name.

**show bgp large-community-list**

**show bgp large-community-list NAME detail**

This command display current large-community-list information. When *name* is specified the community list information is shown.

**show ip bgp large-community-info**

This command displays the current large communities in use.

## Large Communities in Route Map

**match large-community LINE [exact-match]**

Where *line* can be a simple string to match, or a regular expression. It is very important to note that this match occurs on the entire large-community string as a whole, where each large-community is ordered from lowest to highest. When *exact-match* keyword is specified, match happen only when BGP updates have completely same large communities value specified in the large community list.

**set large-community LARGE-COMMUNITY**

**set large-community LARGE-COMMUNITY LARGE-COMMUNITY**

**set large-community LARGE-COMMUNITY additive**

These commands are used for setting large-community values. The first command will overwrite any large-communities currently present. The second specifies two large-communities, which overwrites the current large-community list. The third will add a large-community value without overwriting other values. Multiple large-community values can be specified.

Note that the large expanded community is only used for *match* rule, not for *set* actions.

## L3VPN VRFs

*bgpd* supports L3VPN (Layer 3 Virtual Private Networks) VRFs (Virtual Routing and Forwarding) for IPv4 [RFC 4364](#) and IPv6 [RFC 4659](#). L3VPN routes, and their associated VRF MPLS labels, can be distributed to VPN SAFI neighbors in the *default*, i.e., non VRF, BGP instance. VRF MPLS labels are reached using *core* MPLS labels which are distributed using LDP or BGP labeled unicast. *bgpd* also supports inter-VRF route leaking.

## VRF Route Leaking

BGP routes may be leaked (i.e. copied) between a unicast VRF RIB and the VPN SAFI RIB of the default VRF for use in MPLS-based L3VPNs. Unicast routes may also be leaked between any VRFs (including the unicast RIB of the default BGP instanced). A shortcut syntax is also available for specifying leaking from one VRF to another VRF using the default instance's VPN RIB as the intermediary. A common application of the VRF-VRF feature is to connect a customer's private routing domain to a provider's VPN service. Leaking is configured from the point of view of an individual VRF: *import* refers to routes leaked from VPN to a unicast VRF, whereas *export* refers to routes leaked from a unicast VRF to VPN.

## Required parameters

Routes exported from a unicast VRF to the VPN RIB must be augmented by two parameters:

- an RD (Route Distinguisher)
- an RTLIST (Route-target List)

Configuration for these exported routes must, at a minimum, specify these two parameters.

Routes imported from the VPN RIB to a unicast VRF are selected according to their RTLISTs. Routes whose RTLIST contains at least one route-target in common with the configured import RTLIST are leaked. Configuration for these imported routes must specify an RTLIST to be matched.

The RD, which carries no semantic value, is intended to make the route unique in the VPN RIB among all routes of its prefix that originate from all the customers and sites that are attached to the provider's VPN service. Accordingly, each site of each customer is typically assigned an RD that is unique across the entire provider network.

The RTLIST is a set of route-target extended community values whose purpose is to specify route-leaking policy. Typically, a customer is assigned a single route-target value for import and export to be used at all customer sites. This configuration specifies a simple topology wherein a customer has a single routing domain which is shared across all its sites. More complex routing topologies are possible through use of additional route-targets to augment the leaking of sets of routes in various ways.

When using the shortcut syntax for vrf-to-vrf leaking, the RD and RT are auto-derived.

## General configuration

Configuration of route leaking between a unicast VRF RIB and the VPN SAFI RIB of the default VRF is accomplished via commands in the context of a VRF address-family:

**rd vpn export AS:NN|IP:nn**

Specifies the route distinguisher to be added to a route exported from the current unicast VRF to VPN.

**no rd vpn export [AS:NN|IP:nn]**

Deletes any previously-configured export route distinguisher.

**rt vpn import|export|both RTLIST...**

Specifies the route-target list to be attached to a route (export) or the route-target list to match against (import) when exporting/importing between the current unicast VRF and VPN.

The RTLIST is a space-separated list of route-targets, which are BGP extended community values as described in *Extended Communities Attribute*.

**no rt vpn import|export|both [RTLIST...]**

Deletes any previously-configured import or export route-target list.

**label vpn export (0..1048575)|auto**

Enables an MPLS label to be attached to a route exported from the current unicast VRF to VPN. If the value specified is auto, the label value is automatically assigned from a pool maintained by the Zebra daemon. If Zebra is not running, or if this command is not configured, automatic label assignment will not complete, which will block corresponding route export.

**no label vpn export [(0..1048575)|auto]**

Deletes any previously-configured export label.

**nexthop vpn export A.B.C.D|X:X::X:X**

Specifies an optional nexthop value to be assigned to a route exported from the current unicast VRF to VPN. If left unspecified, the nexthop will be set to 0.0.0.0 or 0:0::0:0 (self).

**no nexthop vpn export [A.B.C.D|X:X::X:X]**

Deletes any previously-configured export nexthop.

**route-map vpn import|export MAP**

Specifies an optional route-map to be applied to routes imported or exported between the current unicast VRF and VPN.

**no route-map vpn import|export [MAP]**

Deletes any previously-configured import or export route-map.

**import|export vpn**

Enables import or export of routes between the current unicast VRF and VPN.

**no import|export vpn**

Disables import or export of routes between the current unicast VRF and VPN.

**import vrf VRFNAME**

Shortcut syntax for specifying automatic leaking from vrf VRFNAME to the current VRF using the VPN RIB as intermediary. The RD and RT are auto derived and should not be specified explicitly for either the source or destination VRF's.

This shortcut syntax mode is not compatible with the explicit *import vpn* and *export vpn* statements for the two VRF's involved. The CLI will disallow attempts to configure incompatible leaking modes.

**no import vrf VRFNAME**

Disables automatic leaking from vrf VRFNAME to the current VRF using the VPN RIB as intermediary.



## Debugging

### show debug

Show all enabled debugs.

### show bgp listeners

Display Listen sockets and the vrf that created them. Useful for debugging of when listen is not working and this is considered a developer debug statement.

### [no] debug bgp neighbor-events

Enable or disable debugging for neighbor events. This provides general information on BGP events such as peer connection / disconnection, session establishment / teardown, and capability negotiation.

### [no] debug bgp updates

Enable or disable debugging for BGP updates. This provides information on BGP UPDATE messages transmitted and received between local and remote instances.

### [no] debug bgp keepalives

Enable or disable debugging for BGP keepalives. This provides information on BGP KEEPALIVE messages transmitted and received between local and remote instances.

### [no] debug bgp bestpath <A.B.C.D/M|X:X::X:X/M>

Enable or disable debugging for bestpath selection on the specified prefix.

### [no] debug bgp nht

Enable or disable debugging of BGP nexthop tracking.

### [no] debug bgp update-groups

Enable or disable debugging of dynamic update groups. This provides general information on group creation, deletion, join and prune events.

### [no] debug bgp zebra

Enable or disable debugging of communications between *bgpd* and *zebra*.

## Dumping Messages and Routing Tables

### dump bgp all PATH [INTERVAL]

### dump bgp all-et PATH [INTERVAL]

### no dump bgp all [PATH] [INTERVAL]

Dump all BGP packet and events to *path* file. If *interval* is set, a new file will be created for echo *interval* of seconds. The path *path* can be set with date and time formatting (strftime). The type 'all-et' enables support for Extended Timestamp Header (packet-binary-dump-format).

### dump bgp updates PATH [INTERVAL]

### dump bgp updates-et PATH [INTERVAL]

### no dump bgp updates [PATH] [INTERVAL]

Dump only BGP updates messages to *path* file. If *interval* is set, a new file will be created for echo *interval* of seconds. The path *path* can be set with date and time formatting (strftime). The type 'updates-et' enables support for Extended Timestamp Header (packet-binary-dump-format).

### dump bgp routes-mrt PATH

**dump bgp routes-mrt PATH INTERVAL**

**no dump bgp route-mrt [PATH] [INTERVAL]**

Dump whole BGP routing table to *path*. This is heavy process. The path *path* can be set with date and time formatting (strftime). If *interval* is set, a new file will be created for echo *interval* of seconds.

Note: the interval variable can also be set using hours and minutes: 04h20m00.

## Other BGP Commands

The following are available in the top level *enable* mode:

**clear bgp \\***

Clear all peers.

**clear bgp ipv4|ipv6 \\***

Clear all peers with this address-family activated.

**clear bgp ipv4|ipv6 unicast \\***

Clear all peers with this address-family and sub-address-family activated.

**clear bgp ipv4|ipv6 PEER**

Clear peers with address of X.X.X.X and this address-family activated.

**clear bgp ipv4|ipv6 unicast PEER**

Clear peer with address of X.X.X.X and this address-family and sub-address-family activated.

**clear bgp ipv4|ipv6 PEER soft|in|out**

Clear peer using soft reconfiguration in this address-family.

**clear bgp ipv4|ipv6 unicast PEER soft|in|out**

Clear peer using soft reconfiguration in this address-family and sub-address-family.

The following are available in the `router bgp` mode:

**write-quanta (1-64)**

BGP message Tx I/O is vectored. This means that multiple packets are written to the peer socket at the same time each I/O cycle, in order to minimize system call overhead. This value controls how many are written at a time. Under certain load conditions, reducing this value could make peer traffic less ‘bursty’. In practice, leave this settings on the default (64) unless you truly know what you are doing.

**read-quanta (1-10)**

Unlike Tx, BGP Rx traffic is not vectored. Packets are read off the wire one at a time in a loop. This setting controls how many iterations the loop runs for. As with write-quanta, it is best to leave this setting on the default.

## Displaying BGP Information

The following four commands display the IPv6 and IPv4 routing tables, depending on whether or not the `ip` keyword is used. Actually, `show ip bgp` command was used on older *Quagga* routing daemon project, while `show bgp` command is the new format. The choice has been done to keep old format with IPv4 routing table, while new format displays IPv6 routing table.

**show ip bgp [wide]**

**show ip bgp A.B.C.D [wide]**

**show bgp [wide]**

**show bgp X:X::X:X [wide]**

These commands display BGP routes. When no route is specified, the default is to display all BGP routes.

```
BGP table version is 0, local router ID is 10.1.1.1
  Status codes: s suppressed, d damped, h history, * valid, > best, i - internal
  Origin codes: i - IGP, e - EGP, ? - incomplete

Network      Next Hop          Metric LocPrf Weight Path
 \*> 1.1.1.1/32      0.0.0.0          0     32768 i

Total number of prefixes 1
```

If `_wide_` option is specified, then the prefix table's width is increased to fully display the prefix and the next hop.

This is especially handy dealing with IPv6 prefixes and if `[no] bgp default show-nexthop-hostname` is enabled.

Some other commands provide additional options for filtering the output.

**show [ip] bgp regexp LINE**

This command displays BGP routes using AS path regular expression (*BGP Regular Expressions*).

**show [ip] bgp summary**

Show a bgp peer summary for the specified address family.

The old command structure `show ip bgp` may be removed in the future and should no longer be used. In order to reach the other BGP routing tables other than the IPv6 routing table given by `show bgp`, the new command structure is extended with `show bgp [afi] [safi]`.

**show bgp [afi] [safi]**

**show bgp <ipv4|ipv6> <unicast|multicast|vpn|labeled-unicast>**

These commands display BGP routes for the specific routing table indicated by the selected afi and the selected safi. If no afi and no safi value is given, the command falls back to the default IPv6 routing table

**show bgp [afi] [safi] summary**

Show a bgp peer summary for the specified address family, and subsequent address-family.

**show bgp [afi] [safi] summary failed [json]**

Show a bgp peer summary for peers that are not successfully exchanging routes for the specified address family, and subsequent address-family.

**show bgp [afi] [safi] summary established [json]**

Show a bgp peer summary for peers that are successfully exchanging routes for the specified address family, and subsequent address-family.

**show bgp [afi] [safi] neighbor [PEER]**

This command shows information on a specific BGP peer of the relevant afi and safi selected.

**show bgp [afi] [safi] dampening dampened-paths**

Display paths suppressed due to dampening of the selected afi and safi selected.

**show bgp [afi] [safi] dampening flap-statistics**

Display flap statistics of routes of the selected afi and safi selected.

**show bgp [afi] [safi] statistics**

Display statistics of routes of the selected afi and safi.

**show bgp statistics-all**

Display statistics of routes of all the afi and safi.

### Displaying Routes by Community Attribute

The following commands allow displaying routes based on their community attribute.

**show [ip] bgp <ipv4|ipv6> community**

**show [ip] bgp <ipv4|ipv6> community COMMUNITY**

**show [ip] bgp <ipv4|ipv6> community COMMUNITY exact-match**

These commands display BGP routes which have the community attribute. When COMMUNITY is specified, BGP routes that match that community are displayed. When *exact-match* is specified, it display only routes that have an exact match.

**show [ip] bgp <ipv4|ipv6> community-list WORD**

**show [ip] bgp <ipv4|ipv6> community-list WORD exact-match**

These commands display BGP routes for the address family specified that match the specified community list. When *exact-match* is specified, it displays only routes that have an exact match.

### Displaying Routes by Large Community Attribute

The following commands allow displaying routes based on their large community attribute.

**show [ip] bgp <ipv4|ipv6> large-community**

**show [ip] bgp <ipv4|ipv6> large-community LARGE-COMMUNITY**

**show [ip] bgp <ipv4|ipv6> large-community LARGE-COMMUNITY exact-match**

**show [ip] bgp <ipv4|ipv6> large-community LARGE-COMMUNITY json**

These commands display BGP routes which have the large community attribute. When LARGE-COMMUNITY is specified, BGP routes that match that large community are displayed. When *exact-match* is specified, it display only routes that have an exact match. When *json* is specified, it display routes in json format.

**show [ip] bgp <ipv4|ipv6> large-community-list WORD**

**show [ip] bgp <ipv4|ipv6> large-community-list WORD exact-match**

**show [ip] bgp <ipv4|ipv6> large-community-list WORD json**

These commands display BGP routes for the address family specified that match the specified large community list. When *exact-match* is specified, it displays only routes that have an exact match. When *json* is specified, it display routes in json format.

## Displaying Routes by AS Path

**show bgp ipv4|ipv6 regexp LINE**

This commands displays BGP routes that matches a regular expression *line* (*BGP Regular Expressions*).

**show [ip] bgp ipv4 vpn**

**show [ip] bgp ipv6 vpn**

Print active IPV4 or IPV6 routes advertised via the VPN SAFI.

**show bgp ipv4 vpn summary**

**show bgp ipv6 vpn summary**

Print a summary of neighbor connections for the specified AFI/SAFI combination.

## Displaying Update Group Information

**show bgp update-groups [advertise-queue|advertised-routes|packet-queue]**

Display Information about each individual update-group being used. If SUBGROUP-ID is specified only display about that particular group. If advertise-queue is specified the list of routes that need to be sent to the peers in the update-group is displayed, advertised-routes means the list of routes we have sent to the peers in the update-group and packet-queue specifies the list of packets in the queue to be sent.

**show bgp update-groups statistics**

Display Information about update-group events in FRR.

## Route Reflector

BGP routers connected inside the same AS through BGP belong to an internal BGP session, or IBGP. In order to prevent routing table loops, IBGP does not advertise IBGP-learned routes to other routers in the same session. As such, IBGP requires a full mesh of all peers. For large networks, this quickly becomes unscalable. Introducing route reflectors removes the need for the full-mesh.

When route reflectors are configured, these will reflect the routes announced by the peers configured as clients. A route reflector client is configured with:

**neighbor PEER route-reflector-client**

**no neighbor PEER route-reflector-client**

To avoid single points of failure, multiple route reflectors can be configured.

A cluster is a collection of route reflectors and their clients, and is used by route reflectors to avoid looping.

**bgp cluster-id A.B.C.D**

## Routing Policy

You can set different routing policy for a peer. For example, you can set different filter for a peer.

```
!  
router bgp 1 view 1  
  neighbor 10.0.0.1 remote-as 2  
  address-family ipv4 unicast  
    neighbor 10.0.0.1 distribute-list 1 in  
  exit-address-family  
!  
router bgp 1 view 2  
  neighbor 10.0.0.1 remote-as 2  
  address-family ipv4 unicast  
    neighbor 10.0.0.1 distribute-list 2 in  
  exit-address-family
```

This means BGP update from a peer 10.0.0.1 goes to both BGP view 1 and view 2. When the update is inserted into view 1, distribute-list 1 is applied. On the other hand, when the update is inserted into view 2, distribute-list 2 is applied.

## BGP Regular Expressions

BGP regular expressions are based on *POSIX 1003.2* regular expressions. The following description is just a quick subset of the POSIX regular expressions.

- .  
Matches any single character.
  - \*  
Matches 0 or more occurrences of pattern.
  - +  
Matches 1 or more occurrences of pattern.
  - ?  
Match 0 or 1 occurrences of pattern.
  - ^  
Matches the beginning of the line.
  - \$  
Matches the end of the line.
  - \_
- The \_ character has special meanings in BGP regular expressions. It matches to space and comma , and AS set delimiter { and } and AS confederation delimiter ( and ). And it also matches to the beginning of the line and the end of the line. So \_ can be used for AS value boundaries match. This character technically evaluates to (^|[,{}()]|\$).

## Miscellaneous Configuration Examples

Example of a session to an upstream, advertising only one prefix to it.

```
router bgp 64512
  bgp router-id 10.236.87.1
  neighbor upstream peer-group
  neighbor upstream remote-as 64515
  neighbor upstream capability dynamic
  neighbor 10.1.1.1 peer-group upstream
  neighbor 10.1.1.1 description ACME ISP

  address-family ipv4 unicast
    network 10.236.87.0/24
    neighbor upstream prefix-list pl-allowed-adv out
  exit-address-family
!
ip prefix-list pl-allowed-adv seq 5 permit 82.195.133.0/25
ip prefix-list pl-allowed-adv seq 10 deny any
```

A more complex example including upstream, peer and customer sessions advertising global prefixes and NO\_EXPORT prefixes and providing actions for customer routes based on community values. Extensive use is made of route-maps and the 'call' feature to support selective advertising of prefixes. This example is intended as guidance only, it has NOT been tested and almost certainly contains silly mistakes, if not serious flaws.

```
router bgp 64512
  bgp router-id 10.236.87.1
  neighbor upstream capability dynamic
  neighbor cust capability dynamic
  neighbor peer capability dynamic
  neighbor 10.1.1.1 remote-as 64515
  neighbor 10.1.1.1 peer-group upstream
  neighbor 10.2.1.1 remote-as 64516
  neighbor 10.2.1.1 peer-group upstream
  neighbor 10.3.1.1 remote-as 64517
  neighbor 10.3.1.1 peer-group cust-default
  neighbor 10.3.1.1 description customer1
  neighbor 10.4.1.1 remote-as 64518
  neighbor 10.4.1.1 peer-group cust
  neighbor 10.4.1.1 description customer2
  neighbor 10.5.1.1 remote-as 64519
  neighbor 10.5.1.1 peer-group peer
  neighbor 10.5.1.1 description peer AS 1
  neighbor 10.6.1.1 remote-as 64520
  neighbor 10.6.1.1 peer-group peer
  neighbor 10.6.1.1 description peer AS 2

  address-family ipv4 unicast
    network 10.123.456.0/24
    network 10.123.456.128/25 route-map rm-no-export
    neighbor upstream route-map rm-upstream-out out
    neighbor cust route-map rm-cust-in in
    neighbor cust route-map rm-cust-out out
    neighbor cust send-community both
```

(continues on next page)

(continued from previous page)

```

neighbor peer route-map rm-peer-in in
neighbor peer route-map rm-peer-out out
neighbor peer send-community both
neighbor 10.3.1.1 prefix-list pl-cust1-network in
neighbor 10.4.1.1 prefix-list pl-cust2-network in
neighbor 10.5.1.1 prefix-list pl-peer1-network in
neighbor 10.6.1.1 prefix-list pl-peer2-network in
exit-address-family
!
ip prefix-list pl-default permit 0.0.0.0/0
!
ip prefix-list pl-upstream-peers permit 10.1.1.1/32
ip prefix-list pl-upstream-peers permit 10.2.1.1/32
!
ip prefix-list pl-cust1-network permit 10.3.1.0/24
ip prefix-list pl-cust1-network permit 10.3.2.0/24
!
ip prefix-list pl-cust2-network permit 10.4.1.0/24
!
ip prefix-list pl-peer1-network permit 10.5.1.0/24
ip prefix-list pl-peer1-network permit 10.5.2.0/24
ip prefix-list pl-peer1-network permit 192.168.0.0/24
!
ip prefix-list pl-peer2-network permit 10.6.1.0/24
ip prefix-list pl-peer2-network permit 10.6.2.0/24
ip prefix-list pl-peer2-network permit 192.168.1.0/24
ip prefix-list pl-peer2-network permit 192.168.2.0/24
ip prefix-list pl-peer2-network permit 172.16.1/24
!
bgp as-path access-list asp-own-as permit ^$
bgp as-path access-list asp-own-as permit _64512_
!
! #####
! Match communities we provide actions for, on routes receives from
! customers. Communities values of <our-ASN>:X, with X, have actions:
!
! 100 - blackhole the prefix
! 200 - set no_export
! 300 - advertise only to other customers
! 400 - advertise only to upstreams
! 500 - set no_export when advertising to upstreams
! 2X00 - set local_preference to X00
!
! blackhole the prefix of the route
bgp community-list standard cm-blackhole permit 64512:100
!
! set no-export community before advertising
bgp community-list standard cm-set-no-export permit 64512:200
!
! advertise only to other customers
bgp community-list standard cm-cust-only permit 64512:300
!

```

(continues on next page)



(continued from previous page)

```

! advertise only to upstreams
bgp community-list standard cm-upstream-only permit 64512:400
!
! advertise to upstreams with no-export
bgp community-list standard cm-upstream-noexport permit 64512:500
!
! set local-pref to least significant 3 digits of the community
bgp community-list standard cm-prefmod-100 permit 64512:2100
bgp community-list standard cm-prefmod-200 permit 64512:2200
bgp community-list standard cm-prefmod-300 permit 64512:2300
bgp community-list standard cm-prefmod-400 permit 64512:2400
bgp community-list expanded cme-prefmod-range permit 64512:2...
!
! Informational communities
!
! 3000 - learned from upstream
! 3100 - learned from customer
! 3200 - learned from peer
!
bgp community-list standard cm-learnt-upstream permit 64512:3000
bgp community-list standard cm-learnt-cust permit 64512:3100
bgp community-list standard cm-learnt-peer permit 64512:3200
!
! #####
! Utility route-maps
!
! These utility route-maps generally should not used to permit/deny
! routes, i.e. they do not have meaning as filters, and hence probably
! should be used with 'on-match next'. These all finish with an empty
! permit entry so as not interfere with processing in the caller.
!
route-map rm-no-export permit 10
  set community additive no-export
route-map rm-no-export permit 20
!
route-map rm-blackhole permit 10
  description blackhole, up-pref and ensure it cannot escape this AS
  set ip next-hop 127.0.0.1
  set local-preference 10
  set community additive no-export
route-map rm-blackhole permit 20
!
! Set local-pref as requested
route-map rm-prefmod permit 10
  match community cm-prefmod-100
  set local-preference 100
route-map rm-prefmod permit 20
  match community cm-prefmod-200
  set local-preference 200
route-map rm-prefmod permit 30
  match community cm-prefmod-300
  set local-preference 300

```

(continues on next page)

(continued from previous page)

```

route-map rm-prefmod permit 40
  match community cm-prefmod-400
  set local-preference 400
route-map rm-prefmod permit 50
!
! Community actions to take on receipt of route.
route-map rm-community-in permit 10
  description check for blackholing, no point continuing if it matches.
  match community cm-blackhole
  call rm-blackhole
route-map rm-community-in permit 20
  match community cm-set-no-export
  call rm-no-export
  on-match next
route-map rm-community-in permit 30
  match community cme-prefmod-range
  call rm-prefmod
route-map rm-community-in permit 40
!
! #####
! Community actions to take when advertising a route.
! These are filtering route-maps,
!
! Deny customer routes to upstream with cust-only set.
route-map rm-community-filt-to-upstream deny 10
  match community cm-learnt-cust
  match community cm-cust-only
route-map rm-community-filt-to-upstream permit 20
!
! Deny customer routes to other customers with upstream-only set.
route-map rm-community-filt-to-cust deny 10
  match community cm-learnt-cust
  match community cm-upstream-only
route-map rm-community-filt-to-cust permit 20
!
! #####
! The top-level route-maps applied to sessions. Further entries could
! be added obviously..
!
! Customers
route-map rm-cust-in permit 10
  call rm-community-in
  on-match next
route-map rm-cust-in permit 20
  set community additive 64512:3100
route-map rm-cust-in permit 30
!
route-map rm-cust-out permit 10
  call rm-community-filt-to-cust
  on-match next
route-map rm-cust-out permit 20
!

```

(continues on next page)

(continued from previous page)

```

! Upstream transit ASes
route-map rm-upstream-out permit 10
  description filter customer prefixes which are marked cust-only
  call rm-community-filt-to-upstream
  on-match next
route-map rm-upstream-out permit 20
  description only customer routes are provided to upstreams/peers
  match community cm-learnt-cust
!
! Peer ASes
! outbound policy is same as for upstream
route-map rm-peer-out permit 10
  call rm-upstream-out
!
route-map rm-peer-in permit 10
  set community additive 64512:3200

```

Example of how to set up a 6-Bone connection.

```

! bgpd configuration
! =====
!
! MP-BGP configuration
!
router bgp 7675
  bgp router-id 10.0.0.1
  neighbor 3ffe:1cfa:0:2:2a0:c9ff:fe9e:f56 remote-as `as-number`
!
  address-family ipv6
  network 3ffe:506::/32
  neighbor 3ffe:1cfa:0:2:2a0:c9ff:fe9e:f56 activate
  neighbor 3ffe:1cfa:0:2:2a0:c9ff:fe9e:f56 route-map set-nexthop out
  neighbor 3ffe:1cfa:0:2:2c0:4fff:fe68:a231 remote-as `as-number`
  neighbor 3ffe:1cfa:0:2:2c0:4fff:fe68:a231 route-map set-nexthop out
  exit-address-family
!
  ipv6 access-list all permit any
!
! Set output nexthop address.
!
route-map set-nexthop permit 10
  match ipv6 address all
  set ipv6 nexthop global 3ffe:1cfa:0:2:2c0:4fff:fe68:a225
  set ipv6 nexthop local fe80::2c0:4fff:fe68:a225
!
log syslog
!

```

## Configuring FRR as a Route Server

The purpose of a Route Server is to centralize the peerings between BGP speakers. For example if we have an exchange point scenario with four BGP speakers, each of which maintaining a BGP peering with the other three (fig-topologies-full), we can convert it into a centralized scenario where each of the four establishes a single BGP peering against the Route Server (fig-topologies-rs).

We will first describe briefly the Route Server model implemented by FRR. We will explain the commands that have been added for configuring that model. And finally we will show a full example of FRR configured as Route Server.

### Description of the Route Server model

First we are going to describe the normal processing that BGP announcements suffer inside a standard BGP speaker, as shown in fig-normal-processing, it consists of three steps:

- When an announcement is received from some peer, the *In* filters configured for that peer are applied to the announcement. These filters can reject the announcement, accept it unmodified, or accept it with some of its attributes modified.
- The announcements that pass the *In* filters go into the Best Path Selection process, where they are compared to other announcements referred to the same destination that have been received from different peers (in case such other announcements exist). For each different destination, the announcement which is selected as the best is inserted into the BGP speaker's Loc-RIB.
- The routes which are inserted in the Loc-RIB are considered for announcement to all the peers (except the one from which the route came). This is done by passing the routes in the Loc-RIB through the *Out* filters corresponding to each peer. These filters can reject the route, accept it unmodified, or accept it with some of its attributes modified. Those routes which are accepted by the *Out* filters of a peer are announced to that peer.

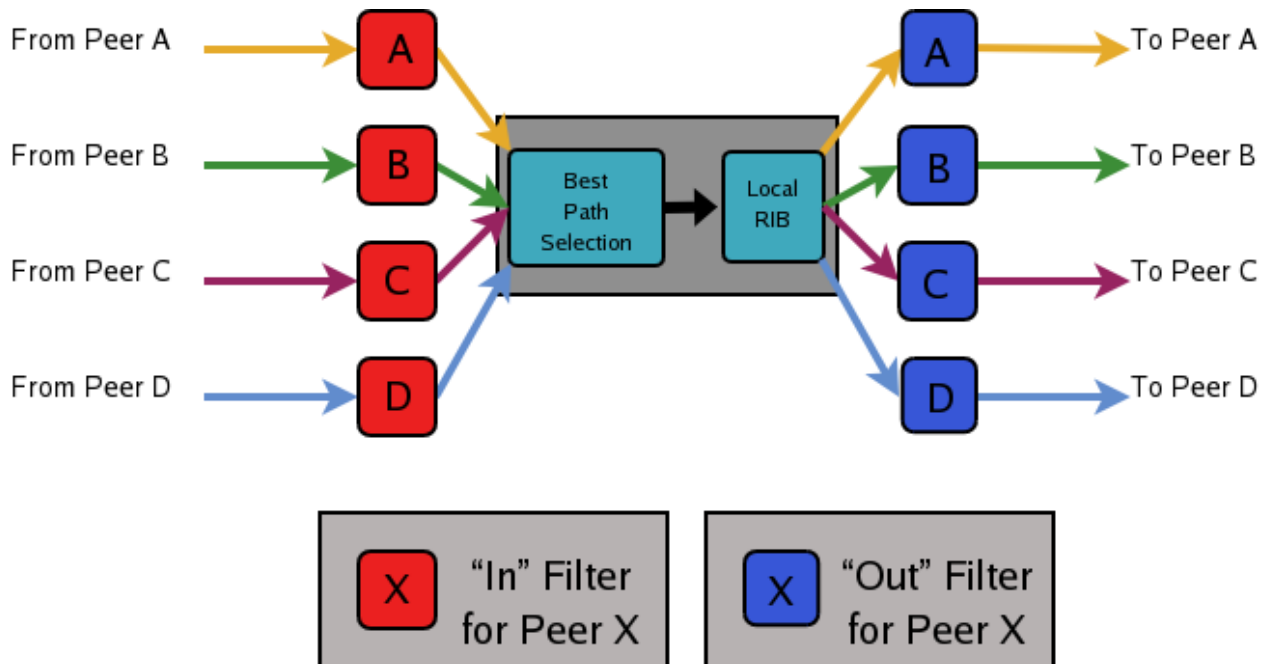

Fig. 1: Announcement processing inside a 'normal' BGP speaker

Of course we want that the routing tables obtained in each of the routers are the same when using the route server than when not. But as a consequence of having a single BGP peering (against the route server), the BGP speakers can no longer distinguish from/to which peer each announce comes/goes.

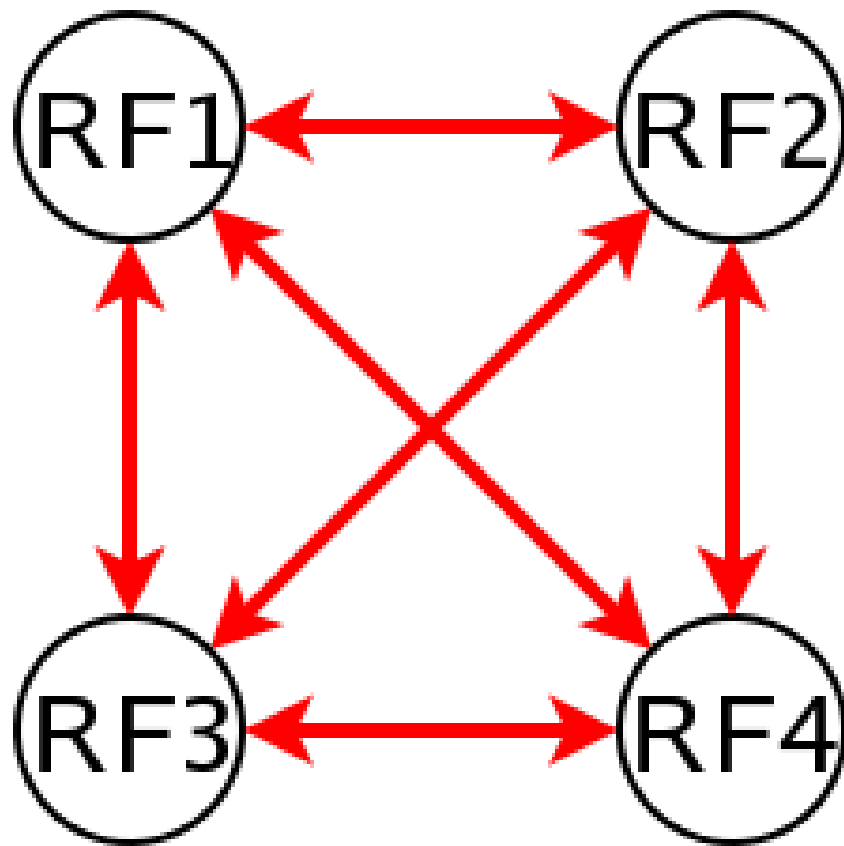

Fig. 2: Full Mesh

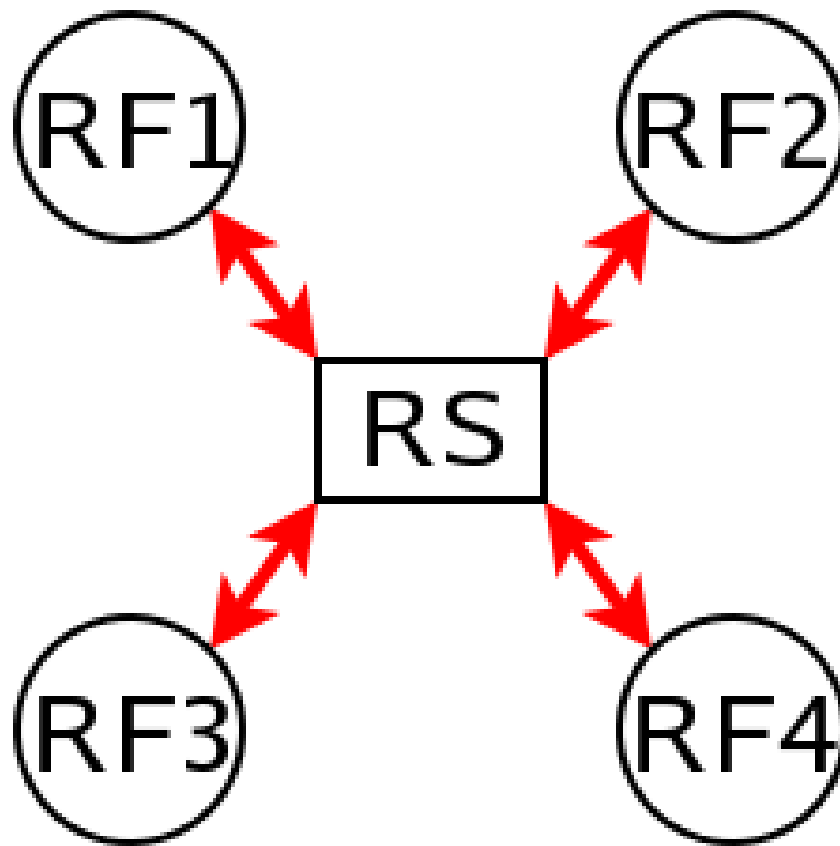

Fig. 3: Route server and clients

This means that the routers connected to the route server are not able to apply by themselves the same input/output filters as in the full mesh scenario, so they have to delegate those functions to the route server.

Even more, the ‘best path’ selection must be also performed inside the route server on behalf of its clients. The reason is that if, after applying the filters of the announcer and the (potential) receiver, the route server decides to send to some client two or more different announcements referred to the same destination, the client will only retain the last one, considering it as an implicit withdrawal of the previous announcements for the same destination. This is the expected behavior of a BGP speaker as defined in [RFC 1771](#), and even though there are some proposals of mechanisms that permit multiple paths for the same destination to be sent through a single BGP peering, none are currently supported by most existing BGP implementations.

As a consequence a route server must maintain additional information and perform additional tasks for a RS-client that those necessary for common BGP peerings. Essentially a route server must:

- Maintain a separated Routing Information Base (Loc-RIB) for each peer configured as RS-client, containing the routes selected as a result of the ‘Best Path Selection’ process that is performed on behalf of that RS-client.
- Whenever it receives an announcement from a RS-client, it must consider it for the Loc-RIBs of the other RS-clients.
  - This means that for each of them the route server must pass the announcement through the appropriate *Out* filter of the announcer.
  - Then through the appropriate *In* filter of the potential receiver.
  - Only if the announcement is accepted by both filters it will be passed to the ‘Best Path Selection’ process.
  - Finally, it might go into the Loc-RIB of the receiver.

When we talk about the ‘appropriate’ filter, both the announcer and the receiver of the route must be taken into account. Suppose that the route server receives an announcement from client A, and the route server is considering it for the Loc-RIB of client B. The filters that should be applied are the same that would be used in the full mesh scenario, i.e., first the *Out* filter of router A for announcements going to router B, and then the *In* filter of router B for announcements coming from router A.

We call ‘Export Policy’ of a RS-client to the set of *Out* filters that the client would use if there was no route server. The same applies for the ‘Import Policy’ of a RS-client and the set of *In* filters of the client if there was no route server.

It is also common to demand from a route server that it does not modify some BGP attributes (next-hop, as-path and MED) that are usually modified by standard BGP speakers before announcing a route.

The announcement processing model implemented by FRR is shown in fig-rs-processing. The figure shows a mixture of RS-clients (B, C and D) with normal BGP peers (A). There are some details that worth additional comments:

- Announcements coming from a normal BGP peer are also considered for the Loc-RIBs of all the RS-clients. But logically they do not pass through any export policy.
- Those peers that are configured as RS-clients do not receive any announce from the *Main* Loc-RIB.
- Apart from import and export policies, *In* and *Out* filters can also be set for RS-clients. *In* filters might be useful when the route server has also normal BGP peers. On the other hand, *Out* filters for RS-clients are probably unnecessary, but we decided not to remove them as they do not hurt anybody (they can always be left empty).

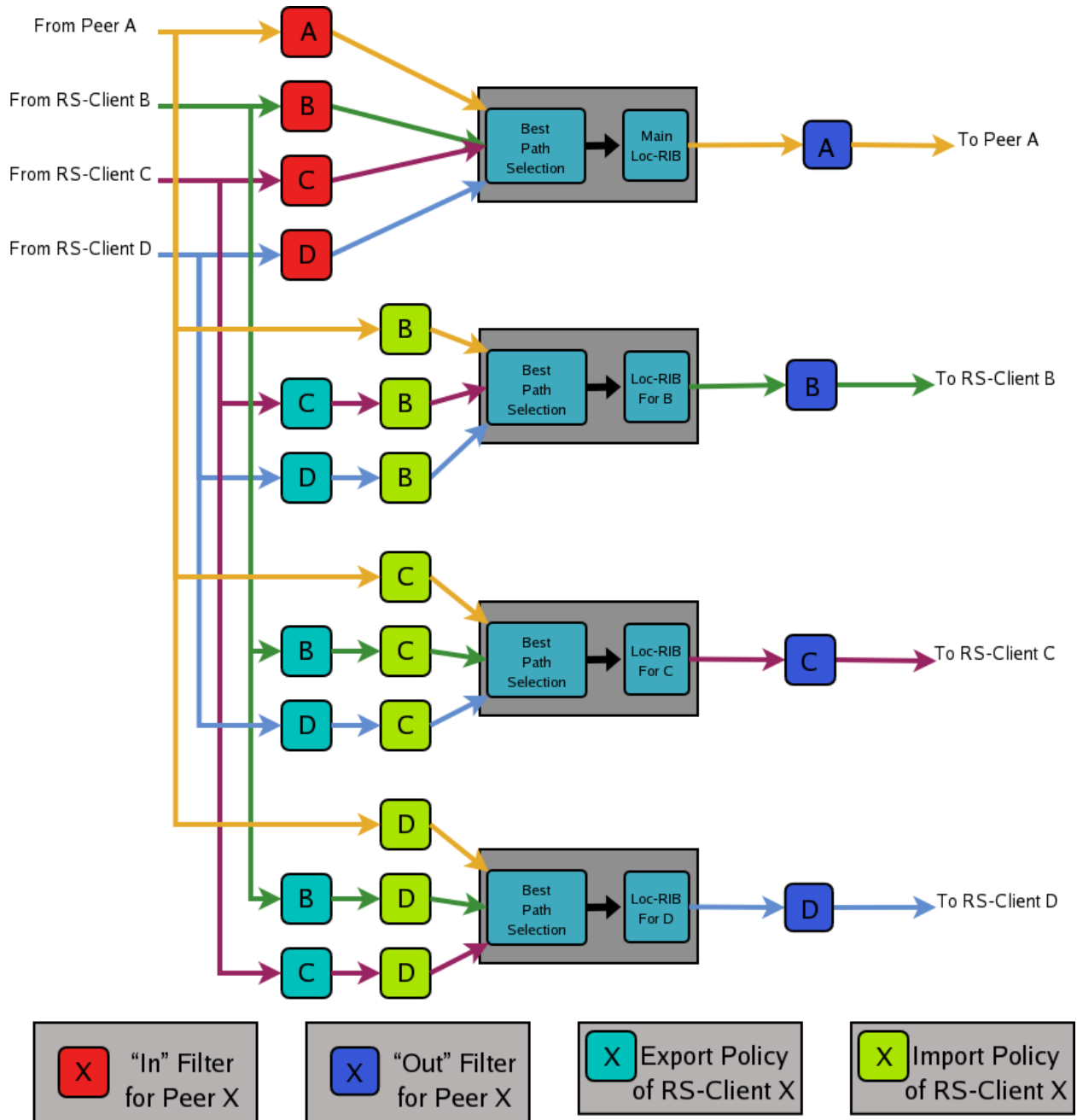

Fig. 4: Announcement processing model implemented by the Route Server



## Commands for configuring a Route Server

Now we will describe the commands that have been added to frr in order to support the route server features.

**neighbor PEER-GROUP route-server-client**

**neighbor A.B.C.D route-server-client**

**neighbor X:X::X:X route-server-client**

This command configures the peer given by *peer*, *A.B.C.D* or *X:X::X:X* as an RS-client.

Actually this command is not new, it already existed in standard FRR. It enables the transparent mode for the specified peer. This means that some BGP attributes (as-path, next-hop and MED) of the routes announced to that peer are not modified.

With the route server patch, this command, apart from setting the transparent mode, creates a new Loc-RIB dedicated to the specified peer (those named *Loc-RIB for X* in fig-rs-processing.). Starting from that moment, every announcement received by the route server will be also considered for the new Loc-RIB.

**neighbor A.B.C.D|X.X::X.X|peer-group route-map WORD import|export**

This set of commands can be used to specify the route-map that represents the Import or Export policy of a peer which is configured as a RS-client (with the previous command).

**match peer A.B.C.D|X.X::X.X**

This is a new *match* statement for use in route-maps, enabling them to describe import/export policies. As we said before, an import/export policy represents a set of input/output filters of the RS-client. This statement makes possible that a single route-map represents the full set of filters that a BGP speaker would use for its different peers in a non-RS scenario.

The *match peer* statement has different semantics whether it is used inside an import or an export route-map. In the first case the statement matches if the address of the peer who sends the announce is the same that the address specified by {A.B.C.D|X:X::X:X}. For export route-maps it matches when {A.B.C.D|X:X::X:X} is the address of the RS-Client into whose Loc-RIB the announce is going to be inserted (how the same export policy is applied before different Loc-RIBs is shown in fig-rs-processing.).

**call WORD**

This command (also used inside a route-map) jumps into a different route-map, whose name is specified by *WORD*. When the called route-map finishes, depending on its result the original route-map continues or not. Apart from being useful for making import/export route-maps easier to write, this command can also be used inside any normal (in or out) route-map.

## Example of Route Server Configuration

Finally we are going to show how to configure a FRR daemon to act as a Route Server. For this purpose we are going to present a scenario without route server, and then we will show how to use the configurations of the BGP routers to generate the configuration of the route server.

All the configuration files shown in this section have been taken from scenarios which were tested using the VNUML tool <http://www.dit.upm.es/vnuml>, VNUML.

## Configuration of the BGP routers without Route Server

We will suppose that our initial scenario is an exchange point with three BGP capable routers, named RA, RB and RC. Each of the BGP speakers generates some routes (with the *network* command), and establishes BGP peerings against the other two routers. These peerings have In and Out route-maps configured, named like 'PEER-X-IN' or 'PEER-X-OUT'. For example the configuration file for router RA could be the following:

```
#Configuration for router 'RA'
!
hostname RA
password ****
!
router bgp 65001
  no bgp default ipv4-unicast
  neighbor 2001:0DB8::B remote-as 65002
  neighbor 2001:0DB8::C remote-as 65003
!
  address-family ipv6
    network 2001:0DB8:AAAA:1::/64
    network 2001:0DB8:AAAA:2::/64
    network 2001:0DB8:0000:1::/64
    network 2001:0DB8:0000:2::/64
    neighbor 2001:0DB8::B activate
    neighbor 2001:0DB8::B soft-reconfiguration inbound
    neighbor 2001:0DB8::B route-map PEER-B-IN in
    neighbor 2001:0DB8::B route-map PEER-B-OUT out
    neighbor 2001:0DB8::C activate
    neighbor 2001:0DB8::C soft-reconfiguration inbound
    neighbor 2001:0DB8::C route-map PEER-C-IN in
    neighbor 2001:0DB8::C route-map PEER-C-OUT out
  exit-address-family
!
  ipv6 prefix-list COMMON-PREFIXES seq 5 permit 2001:0DB8:0000::/48 ge 64 le 64
  ipv6 prefix-list COMMON-PREFIXES seq 10 deny any
!
  ipv6 prefix-list PEER-A-PREFIXES seq 5 permit 2001:0DB8:AAAA::/48 ge 64 le 64
  ipv6 prefix-list PEER-A-PREFIXES seq 10 deny any
!
  ipv6 prefix-list PEER-B-PREFIXES seq 5 permit 2001:0DB8:BBBB::/48 ge 64 le 64
  ipv6 prefix-list PEER-B-PREFIXES seq 10 deny any
!
  ipv6 prefix-list PEER-C-PREFIXES seq 5 permit 2001:0DB8:CCCC::/48 ge 64 le 64
  ipv6 prefix-list PEER-C-PREFIXES seq 10 deny any
!
  route-map PEER-B-IN permit 10
    match ipv6 address prefix-list COMMON-PREFIXES
    set metric 100
  route-map PEER-B-IN permit 20
    match ipv6 address prefix-list PEER-B-PREFIXES
    set community 65001:1111
!
  route-map PEER-C-IN permit 10
    match ipv6 address prefix-list COMMON-PREFIXES
```

(continues on next page)

(continued from previous page)

```

    set metric 200
route-map PEER-C-IN permit 20
    match ipv6 address prefix-list PEER-C-PREFIXES
    set community 65001:2222
!
route-map PEER-B-OUT permit 10
    match ipv6 address prefix-list PEER-A-PREFIXES
!
route-map PEER-C-OUT permit 10
    match ipv6 address prefix-list PEER-A-PREFIXES
!
line vty
!
```

### Configuration of the BGP routers with Route Server

To convert the initial scenario into one with route server, first we must modify the configuration of routers RA, RB and RC. Now they must not peer between them, but only with the route server. For example, RA's configuration would turn into:

```

# Configuration for router 'RA'
!
hostname RA
password ****
!
router bgp 65001
    no bgp default ipv4-unicast
    neighbor 2001:0DB8::FFFF remote-as 65000
!
    address-family ipv6
        network 2001:0DB8:AAAA:1::/64
        network 2001:0DB8:AAAA:2::/64
        network 2001:0DB8:0000:1::/64
        network 2001:0DB8:0000:2::/64

        neighbor 2001:0DB8::FFFF activate
        neighbor 2001:0DB8::FFFF soft-reconfiguration inbound
    exit-address-family
!
line vty
!
```

Which is logically much simpler than its initial configuration, as it now maintains only one BGP peering and all the filters (route-maps) have disappeared.

## Configuration of the Route Server itself

As we said when we described the functions of a route server (description-of-the-route-server-model), it is in charge of all the route filtering. To achieve that, the In and Out filters from the RA, RB and RC configurations must be converted into Import and Export policies in the route server.

This is a fragment of the route server configuration (we only show the policies for client RA):

```
# Configuration for Route Server ('RS')
!
hostname RS
password ix
!
router bgp 65000 view RS
  no bgp default ipv4-unicast
  neighbor 2001:0DB8::A remote-as 65001
  neighbor 2001:0DB8::B remote-as 65002
  neighbor 2001:0DB8::C remote-as 65003
!
  address-family ipv6
    neighbor 2001:0DB8::A activate
    neighbor 2001:0DB8::A route-server-client
    neighbor 2001:0DB8::A route-map RSCLIENT-A-IMPORT import
    neighbor 2001:0DB8::A route-map RSCLIENT-A-EXPORT export
    neighbor 2001:0DB8::A soft-reconfiguration inbound

    neighbor 2001:0DB8::B activate
    neighbor 2001:0DB8::B route-server-client
    neighbor 2001:0DB8::B route-map RSCLIENT-B-IMPORT import
    neighbor 2001:0DB8::B route-map RSCLIENT-B-EXPORT export
    neighbor 2001:0DB8::B soft-reconfiguration inbound

    neighbor 2001:0DB8::C activate
    neighbor 2001:0DB8::C route-server-client
    neighbor 2001:0DB8::C route-map RSCLIENT-C-IMPORT import
    neighbor 2001:0DB8::C route-map RSCLIENT-C-EXPORT export
    neighbor 2001:0DB8::C soft-reconfiguration inbound
  exit-address-family
!
  ipv6 prefix-list COMMON-PREFIXES seq 5 permit 2001:0DB8:0000::/48 ge 64 le 64
  ipv6 prefix-list COMMON-PREFIXES seq 10 deny any
!
  ipv6 prefix-list PEER-A-PREFIXES seq 5 permit 2001:0DB8:AAAA::/48 ge 64 le 64
  ipv6 prefix-list PEER-A-PREFIXES seq 10 deny any
!
  ipv6 prefix-list PEER-B-PREFIXES seq 5 permit 2001:0DB8:BBBB::/48 ge 64 le 64
  ipv6 prefix-list PEER-B-PREFIXES seq 10 deny any
!
  ipv6 prefix-list PEER-C-PREFIXES seq 5 permit 2001:0DB8:CCCC::/48 ge 64 le 64
  ipv6 prefix-list PEER-C-PREFIXES seq 10 deny any
!
  route-map RSCLIENT-A-IMPORT permit 10
    match peer 2001:0DB8::B
    call A-IMPORT-FROM-B
```

(continues on next page)

(continued from previous page)

```

route-map RSCLIENT-A-IMPORT permit 20
  match peer 2001:0DB8::C
  call A-IMPORT-FROM-C
!
route-map A-IMPORT-FROM-B permit 10
  match ipv6 address prefix-list COMMON-PREFIXES
  set metric 100
route-map A-IMPORT-FROM-B permit 20
  match ipv6 address prefix-list PEER-B-PREFIXES
  set community 65001:11111
!
route-map A-IMPORT-FROM-C permit 10
  match ipv6 address prefix-list COMMON-PREFIXES
  set metric 200
route-map A-IMPORT-FROM-C permit 20
  match ipv6 address prefix-list PEER-C-PREFIXES
  set community 65001:22222
!
route-map RSCLIENT-A-EXPORT permit 10
  match peer 2001:0DB8::B
  match ipv6 address prefix-list PEER-A-PREFIXES
route-map RSCLIENT-A-EXPORT permit 20
  match peer 2001:0DB8::C
  match ipv6 address prefix-list PEER-A-PREFIXES
!
...
...
...

```

If you compare the initial configuration of RA with the route server configuration above, you can see how easy it is to generate the Import and Export policies for RA from the In and Out route-maps of RA's original configuration.

When there was no route server, RA maintained two peerings, one with RB and another with RC. Each of this peerings had an In route-map configured. To build the Import route-map for client RA in the route server, simply add route-map entries following this scheme:

```

route-map <NAME> permit 10
  match peer <Peer Address>
  call <In Route-Map for this Peer>
route-map <NAME> permit 20
  match peer <Another Peer Address>
  call <In Route-Map for this Peer>

```

This is exactly the process that has been followed to generate the route-map RSCLIENT-A-IMPORT. The route-maps that are called inside it (A-IMPORT-FROM-B and A-IMPORT-FROM-C) are exactly the same as the In route-maps from the original configuration of RA (PEER-B-IN and PEER-C-IN), only the name is different.

The same could have been done to create the Export policy for RA (route-map RSCLIENT-A-EXPORT), but in this case the original Out route-maps were so simple that we decided not to use the *call WORD* commands, and we integrated all in a single route-map (RSCLIENT-A-EXPORT).

The Import and Export policies for RB and RC are not shown, but the process would be identical.

## Further considerations about Import and Export route-maps

The current version of the route server patch only allows to specify a route-map for import and export policies, while in a standard BGP speaker apart from route-maps there are other tools for performing input and output filtering (access-lists, community-lists, ...). But this does not represent any limitation, as all kinds of filters can be included in import/export route-maps. For example suppose that in the non-route-server scenario peer RA had the following filters configured for input from peer B:

```
neighbor 2001:0DB8::B prefix-list LIST-1 in
neighbor 2001:0DB8::B filter-list LIST-2 in
neighbor 2001:0DB8::B route-map PEER-B-IN in
...
...
route-map PEER-B-IN permit 10
  match ipv6 address prefix-list COMMON-PREFIXES
  set local-preference 100
route-map PEER-B-IN permit 20
  match ipv6 address prefix-list PEER-B-PREFIXES
  set community 65001:11111
```

It is possible to write a single route-map which is equivalent to the three filters (the community-list, the prefix-list and the route-map). That route-map can then be used inside the Import policy in the route server. Lets see how to do it:

```
neighbor 2001:0DB8::A route-map RSCLIENT-A-IMPORT import
...
!
...
route-map RSCLIENT-A-IMPORT permit 10
  match peer 2001:0DB8::B
  call A-IMPORT-FROM-B
...
...
!
route-map A-IMPORT-FROM-B permit 1
  match ipv6 address prefix-list LIST-1
  match as-path LIST-2
  on-match goto 10
route-map A-IMPORT-FROM-B deny 2
route-map A-IMPORT-FROM-B permit 10
  match ipv6 address prefix-list COMMON-PREFIXES
  set local-preference 100
route-map A-IMPORT-FROM-B permit 20
  match ipv6 address prefix-list PEER-B-PREFIXES
  set community 65001:11111
!
...
...
```

The route-map A-IMPORT-FROM-B is equivalent to the three filters (LIST-1, LIST-2 and PEER-B-IN). The first entry of route-map A-IMPORT-FROM-B (sequence number 1) matches if and only if both the prefix-list LIST-1 and the filter-list LIST-2 match. If that happens, due to the 'on-match goto 10' statement the next route-map entry to be processed will be number 10, and as of that point route-map A-IMPORT-FROM-B is identical to PEER-B-IN. If the first entry does not match, *on-match goto 10*' will be ignored and the next processed entry will be number 2, which will deny the route.

Thus, the result is the same that with the three original filters, i.e., if either LIST-1 or LIST-2 rejects the route, it does not reach the route-map PEER-B-IN. In case both LIST-1 and LIST-2 accept the route, it passes to PEER-B-IN, which can reject, accept or modify the route.

## Weighted ECMP using BGP link bandwidth

### Overview

In normal equal cost multipath (ECMP), the route to a destination has multiple next hops and traffic is expected to be equally distributed across these next hops. In practice, flow-based hashing is used so that all traffic associated with a particular flow uses the same next hop, and by extension, the same path across the network.

Weighted ECMP using BGP link bandwidth introduces support for network-wide unequal cost multipathing (UCMP) to an IP destination. The unequal cost load balancing is implemented by the forwarding plane based on the weights associated with the next hops of the IP prefix. These weights are computed based on the bandwidths of the corresponding multipaths which are encoded in the `BGP link bandwidth extended community` as specified in [?]. Exchange of an appropriate BGP link bandwidth value for a prefix across the network results in network-wide unequal cost multipathing.

One of the primary use cases of this capability is in the data center when a service (represented by its anycast IP) has an unequal set of resources across the regions (e.g., PODs) of the data center and the network itself provides the load balancing function instead of an external load balancer. Refer to [?] and [RFC 7938](#) for details on this use case. This use case is applicable in a pure L3 network as well as in a EVPN network.

The traditional use case for BGP link bandwidth to load balance traffic to the exit routers in the AS based on the bandwidth of their external eBGP peering links is also supported.

### Design Principles

#### Next hop weight computation and usage

As described, in UCMP, there is a weight associated with each next hop of an IP prefix, and traffic is expected to be distributed across the next hops in proportion to their weight. The weight of a next hop is a simple factoring of the bandwidth of the corresponding path against the total bandwidth of all multipaths, mapped to the range 1 to 100. What happens if not all the paths in the multipath set have link bandwidth associated with them? In such a case, in adherence to [?], the behavior reverts to standard ECMP among all the multipaths, with the link bandwidth being effectively ignored.

Note that there is no change to either the BGP best path selection algorithm or to the multipath computation algorithm; the mapping of link bandwidth to weight happens at the time of installation of the route in the RIB.

#### Unequal cost multipath across a network

For the use cases listed above, it is not sufficient to support UCMP on just one router (e.g., egress router), or individually, on multiple routers; UCMP must be deployed across the entire network. This is achieved by employing the BGP link-bandwidth extended community.

At the router which originates the BGP link bandwidth, there has to be user configuration to trigger it, which is described below. Receiving routers would use the received link bandwidth from their downstream routers to determine the next hop weight as described in the earlier section. Further, if the received link bandwidth is a transitive attribute, it would be propagated to eBGP peers, with the additional change that if the next hop is set to oneself, the cumulative link bandwidth of all downstream paths is propagated to other routers. In this manner, the entire network will know how to distribute traffic to an anycast service across the network.

The BGP link-bandwidth extended community is encoded in bytes-per-second. In the use case where UCMP must be based on the number of paths, a reference bandwidth of 1 Mbps is used. So, for example, if there are 4 equal cost paths to an anycast IP, the encoded bandwidth in the extended community will be 500,000. The actual value itself doesn't matter as long as all routers originating the link-bandwidth are doing it in the same way.

## Configuration Guide

The configuration for weighted ECMP using BGP link bandwidth requires one essential step - using a route-map to inject the link bandwidth extended community. An additional option is provided to control the processing of received link bandwidth.

### Injecting link bandwidth into the network

At the “entry point” router that is injecting the prefix to which weighted load balancing must be performed, a route-map must be configured to attach the link bandwidth extended community.

For the use case of providing weighted load balancing for an anycast service, this configuration will typically need to be applied at the TOR or Leaf router that is connected to servers which provide the anycast service and the bandwidth would be based on the number of multipaths for the destination.

For the use case of load balancing to the exit router, the exit router should be configured with the route map specifying the a bandwidth value that corresponds to the bandwidth of the link connecting to its eBGP peer in the adjoining AS. In addition, the link bandwidth extended community must be explicitly configured to be non-transitive.

The complete syntax of the route-map set command can be found at [BGP Extended Communities in Route Map](#)

This route-map is supported only at two attachment points: (a) the outbound route-map attached to a peer or peer-group, per address-family (b) the EVPN advertise route-map used to inject IPv4 or IPv6 unicast routes into EVPN as type-5 routes.

Since the link bandwidth origination is done by using a route-map, it can be constrained to certain prefixes (e.g., only for anycast services) or it can be generated for all prefixes. Further, when the route-map is used in the neighbor context, the link bandwidth usage can be constrained to certain peers only.

A sample configuration is shown below and illustrates link bandwidth advertisement towards the “SPINE” peer-group for anycast IPs in the range 192.168.x.x

```
ip prefix-list anycast_ip seq 10 permit 192.168.0.0/16 le 32
route-map anycast_ip permit 10
  match ip address prefix-list anycast_ip
  set extcommunity bandwidth num-multipaths
route-map anycast_ip permit 20
!
router bgp 65001
  neighbor SPINE peer-group
  neighbor SPINE remote-as external
  neighbor 172.16.35.1 peer-group SPINE
  neighbor 172.16.36.1 peer-group SPINE
!
  address-family ipv4 unicast
    network 110.0.0.1/32
    network 192.168.44.1/32
    neighbor SPINE route-map anycast_ip out
  exit-address-family
!
```



## Controlling link bandwidth processing on the receiver

There is no configuration necessary to process received link bandwidth and translate it into the weight associated with the corresponding next hop; that happens by default. If some of the multipaths do not have the link bandwidth extended community, the default behavior is to revert to normal ECMP as recommended in [?].

The operator can change these behaviors with the following configuration:

```
bgp bestpath bandwidth <ignore | skip-missing | default-weight-for-missing>
```

The different options imply behavior as follows:

- **ignore**: Ignore link bandwidth completely for route installation (i.e., do regular ECMP, not weighted)
- **skip-missing**: Skip paths without link bandwidth and do UCMP among the others (if at least some paths have link-bandwidth)
- **default-weight-for-missing**: Assign a low default weight (value 1) to paths not having link bandwidth

This configuration is per BGP instance similar to other BGP route-selection controls; it operates on both IPv4-unicast and IPv6-unicast routes in that instance. In an EVPN network, this configuration (if required) should be implemented in the tenant VRF and is again applicable for IPv4-unicast and IPv6-unicast, including the ones sourced from EVPN type-5 routes.

A sample snippet of FRR configuration on a receiver to skip paths without link bandwidth and do weighted ECMP among the other paths (if some of them have link bandwidth) is as shown below.

```
router bgp 65021
  bgp bestpath as-path multipath-relax
  bgp bestpath bandwidth skip-missing
  neighbor LEAF peer-group
  neighbor LEAF remote-as external
  neighbor 172.16.35.2 peer-group LEAF
  neighbor 172.16.36.2 peer-group LEAF
  !
  address-family ipv4 unicast
    network 130.0.0.1/32
  exit-address-family
  !
```

## Stopping the propagation of the link bandwidth outside a domain

The link bandwidth extended community will get automatically propagated with the prefix to EBGp peers, if it is encoded as a transitive attribute by the originator. If this propagation has to be stopped outside of a particular domain (e.g., stopped from being propagated to routers outside of the data center core network), the mechanism available is to disable the advertisement of all BGP extended communities on the specific peering/s. In other words, the propagation cannot be blocked just for the link bandwidth extended community. The configuration to disable all extended communities can be applied to a peer or peer-group (per address-family).

Of course, the other common way to stop the propagation of the link bandwidth outside the domain is to block the prefixes themselves from being advertised and possibly, announce only an aggregate route. This would be quite common in a EVPN network.

## BGP link bandwidth and UCMP monitoring & troubleshooting

Existing operational commands to display the BGP routing table for a specific prefix will show the link bandwidth extended community also, if present.

An example of an IPv4-unicast route received with the link bandwidth attribute from two peers is shown below:

```
CLI# show bgp ipv4 unicast 192.168.10.1/32
BGP routing table entry for 192.168.10.1/32
Paths: (2 available, best #2, table default)
  Advertised to non peer-group peers:
  l1(swp1) l2(swp2) l3(swp3) l4(swp4)
  65002
    fe80::202:ff:fe00:1b from l2(swp2) (110.0.0.2)
    (fe80::202:ff:fe00:1b) (used)
    Origin IGP, metric 0, valid, external, multipath, bestpath-from-AS 65002
    Extended Community: LB:65002:125000000 (1000.000 Mbps)
    Last update: Thu Feb 20 18:34:16 2020

  65001
    fe80::202:ff:fe00:15 from l1(swp1) (110.0.0.1)
    (fe80::202:ff:fe00:15) (used)
    Origin IGP, metric 0, valid, external, multipath, bestpath-from-AS 65001, best_
    ←(Older Path)
    Extended Community: LB:65001:625000000 (500.000 Mbps)
    Last update: Thu Feb 20 18:22:34 2020
```

The weights associated with the next hops of a route can be seen by querying the RIB for a specific route.

For example, the next hop weights corresponding to the link bandwidths in the above example is illustrated below:

```
spine1# show ip route 192.168.10.1/32
Routing entry for 192.168.10.1/32
  Known via "bgp", distance 20, metric 0, best
  Last update 00:00:32 ago
  * fe80::202:ff:fe00:1b, via swp2, weight 66
  * fe80::202:ff:fe00:15, via swp1, weight 33
```

For troubleshooting, existing debug logs `debug bgp updates`, `debug bgp bestpath <prefix>`, `debug bgp zebra` and `debug zebra kernel` can be used.

A debug log snippet when `debug bgp zebra` is enabled and a route is installed by BGP in the RIB with next hop weights is shown below:

```
2020-02-29T06:26:19.927754+00:00 leaf1 bgpd[5459]: bgp_zebra_announce: p=192.168.150.1/
  ←32, bgp_is_valid_label: 0
2020-02-29T06:26:19.928096+00:00 leaf1 bgpd[5459]: Tx route add VRF 33 192.168.150.1/32_
  ←metric 0 tag 0 count 2
2020-02-29T06:26:19.928289+00:00 leaf1 bgpd[5459]:  nhop [1]: 110.0.0.6 if 35 VRF 33 wt_
  ←50  RMAC 0a:11:2f:7d:35:20
2020-02-29T06:26:19.928479+00:00 leaf1 bgpd[5459]:  nhop [2]: 110.0.0.5 if 35 VRF 33 wt_
  ←50  RMAC 32:1e:32:a3:6c:bf
2020-02-29T06:26:19.928668+00:00 leaf1 bgpd[5459]: bgp_zebra_announce: 192.168.150.1/32:_
  ←announcing to zebra (recursion NOT set)
```

## References

### 1.4.3 LDP

The *ldpd* daemon is a standardised protocol that permits exchanging MPLS label information between MPLS devices. The LDP protocol creates peering between devices, so as to exchange that label information. This information is stored in MPLS table of *zebra*, and it injects that MPLS information in the underlying system (Linux kernel or OpenBSD system for instance). *ldpd* provides necessary options to create a Layer 2 VPN across MPLS network. For instance, it is possible to interconnect several sites that share the same broadcast domain.

FRR implements LDP as described in [RFC 5036](#); other LDP standard are the following ones: [RFC 6720](#), [RFC 6667](#), [RFC 5919](#), [RFC 5561](#), [RFC 7552](#), [RFC 4447](#). Because MPLS is already available, FRR also supports [RFC 3031](#).

### Understanding LDP principles

Let's first introduce some definitions that permit understand better the LDP protocol:

- **LSR** : Labeled Switch Router. Networking devices handling labels used to forward traffic between and through them.
- **LER**  
[Labeled Edge Router. A Labeled edge router is located at the edge of] an MPLS network, generally between an IP network and an MPLS network.

LDP aims at sharing label information across devices. It tries to establish peering with remote LDP capable devices, first by discovering using UDP port 646 , then by peering using TCP port 646. Once the TCP session is established, the label information is shared, through label advertisements.

There are different methods to send label advertisement modes. The implementation actually supports the following : Liberal Label Retention + Downstream Unsolicited + Independent Control. The other advertising modes are depicted below, and compared with the current implementation.

- Liberal label retention versus conservative mode In liberal mode, every label sent by every LSR is stored in the MPLS table. In conservative mode, only the label that was sent by the best next hop (determined by the IGP metric) for that particular FEC is stored in the MPLS table.
- Independent LSP Control versus ordered LSP Control MPLS has two ways of binding labels to FEC's; either through ordered LSP control, or independent LSP control. Ordered LSP control only binds a label to a FEC if it is the egress LSR, or the router received a label binding for a FEC from the next hop router. In this mode, an MPLS router will create a label binding for each FEC and distribute it to its neighbors so long as he has a entry in the RIB for the destination. In the other mode, label bindings are made without any dependencies on another router advertising a label for a particular FEC. Each router makes it own independent decision to create a label for each FEC. By default IOS uses Independent LSP Control, while Juniper implements the Ordered Control. Both modes are interoperable, the difference is that Ordered Control prevent blackholing during the LDP convergence process, at cost of slowing down the convergence itself
- unsolicited downstream versus downstream on demand Downstream on demand label distribution is where an LSR must explicitly request that a label be sent from its downstream router for a particular FEC. Unsolicited label distribution is where a label is sent from the downstream router without the original router requesting it.

## LDP Configuration

**[no] mpls ldp**

Enable or disable LDP daemon

**[no] router-id A.B.C.D**

The following command located under MPLS router node configures the MPLS router-id of the local device.

**[no] ordered-control**

Configure LDP Ordered Label Distribution Control.

**[no] address-family [ipv4 | ipv6]**

Configure LDP for IPv4 or IPv6 address-family. Located under MPLS route node, this subnode permits configuring the LDP neighbors.

**[no] interface IFACE**

Located under MPLS address-family node, use this command to enable or disable LDP discovery per interface. IFACE stands for the interface name where LDP is enabled. By default it is disabled. Once this command executed, the address-family interface node is configured.

**[no] discovery transport-address A.B.C.D | A:B::C:D**

Located under mpls address-family interface node, use this command to set the IPv4 or IPv6 transport-address used by the LDP protocol to talk on this interface.

**[no] neighbor A.B.C.D password PASSWORD**

The following command located under MPLS router node configures the router of a LDP device. This device, if found, will have to comply with the configured password. PASSWORD is a clear text password with its digest sent through the network.

**[no] neighbor A.B.C.D holdtime HOLDTIME**

The following command located under MPLS router node configures the holdtime value in seconds of the LDP neighbor ID. Configuring it triggers a keepalive mechanism. That value can be configured between 15 and 65535 seconds. After this time of non response, the LDP established session will be considered as set to down. By default, no holdtime is configured for the LDP devices.

**[no] discovery hello holdtime HOLDTIME**

**[no] discovery hello interval INTERVAL**

INTERVAL value ranges from 1 to 65535 seconds. Default value is 5 seconds. This is the value between each hello timer message sent. HOLDTIME value ranges from 1 to 65535 seconds. Default value is 15 seconds. That value is added as a TLV in the LDP messages.

**[no] dual-stack transport-connection prefer ipv4**

When *ldpd* is configured for dual-stack operation, the transport connection preference is IPv6 by default (as specified by [RFC 7552](#)). On such circumstances, *ldpd* will refuse to establish TCP connections over IPv4. You can use above command to change the transport connection preference to IPv4. In this case, it will be possible to distribute label mappings for IPv6 FECs over TCPv4 connections.

## Show LDP Information

These commands dump various parts of *ldpd*.

### **show mpls ldp neighbor [A.B.C.D]**

This command dumps the various neighbors discovered. Below example shows that local machine has an operation neighbor with ID set to 1.1.1.1.

```
west-vm# show mpls ldp neighbor
AF  ID                State      Remote Address  Uptime
ipv4 1.1.1.1           OPERATIONAL 1.1.1.1        00:01:37
west-vm#
```

### **show mpls ldp neighbor [A.B.C.D] capabilities**

### **show mpls ldp neighbor [A.B.C.D] detail**

Above commands dump other neighbor information.

### **show mpls ldp discovery [detail]**

### **show mpls ldp ipv4 discovery [detail]**

### **show mpls ldp ipv6 discovery [detail]**

Above commands dump discovery information.

### **show mpls ldp ipv4 interface**

### **show mpls ldp ipv6 interface**

Above command dumps the IPv4 or IPv6 interface per where LDP is enabled. Below output illustrates what is dumped for IPv4.

```
west-vm# show mpls ldp ipv4 interface
AF  Interface  State  Uptime  Hello Timers  ac
ipv4 eth1     ACTIVE 00:08:35 5/15      0
ipv4 eth3     ACTIVE 00:08:35 5/15      1
```

### **show mpls ldp ipv4|ipv6 binding**

Above command dumps the binding obtained through MPLS exchanges with LDP.

```
west-vm# show mpls ldp ipv4 binding
AF  Destination      Nexthop      Local Label  Remote Label  In Use
ipv4 1.1.1.1/32        1.1.1.1      16           imp-null      yes
ipv4 2.2.2.2/32        1.1.1.1      imp-null     16           no
ipv4 10.0.2.0/24      1.1.1.1      imp-null     imp-null     no
ipv4 10.115.0.0/24    1.1.1.1      imp-null     17           no
ipv4 10.135.0.0/24    1.1.1.1      imp-null     imp-null     no
ipv4 10.200.0.0/24    1.1.1.1      17           imp-null     yes
west-vm#
```

## LDP debugging commands

### [no] debug mpls ldp KIND

Enable or disable debugging messages of a given kind. KIND can be one of:

- discovery
- errors
- event
- labels
- messages
- zebra

## LDP Example Configuration

Below configuration gives a typical MPLS configuration of a device located in a MPLS backbone. LDP is enabled on two interfaces and will attempt to peer with two neighbors with router-id set to either 1.1.1.1 or 3.3.3.3.

```
mpls ldp
router-id 2.2.2.2
neighbor 1.1.1.1 password test
neighbor 3.3.3.3 password test
!
address-family ipv4
discovery transport-address 2.2.2.2
!
interface eth1
!
interface eth3
!
exit-address-family
!
```

Deploying LDP across a backbone generally is done in a full mesh configuration topology. LDP is typically deployed with an IGP like OSPF, that helps discover the remote IPs. Below example is an OSPF configuration extract that goes with LDP configuration

```
router ospf
ospf router-id 2.2.2.2
network 0.0.0.0/0 area 0
!
```

Below output shows the routing entry on the LER side. The OSPF routing entry (10.200.0.0) is associated with Label entry (17), and shows that MPLS push action that traffic to that destination will be applied.

```
north-vm# show ip route
Codes: K - kernel route, C - connected, S - static, R - RIP,
O - OSPF, I - IS-IS, B - BGP, E - EIGRP, N - NHRP,
T - Table, v - VNC, V - VNC-Direct, A - Babel, D - SHARP,
F - PBR,
> - selected route, * - FIB route
```

(continues on next page)

(continued from previous page)

```

O>* 1.1.1.1/32 [110/120] via 10.115.0.1, eth2, label 16, 00:00:15
O>* 2.2.2.2/32 [110/20] via 10.115.0.1, eth2, label implicit-null, 00:00:15
O 3.3.3.3/32 [110/10] via 0.0.0.0, loopback1 onlink, 00:01:19
C>* 3.3.3.3/32 is directly connected, loopback1, 00:01:29
O>* 10.0.2.0/24 [110/11] via 10.115.0.1, eth2, label implicit-null, 00:00:15
O 10.100.0.0/24 [110/10] is directly connected, eth1, 00:00:32
C>* 10.100.0.0/24 is directly connected, eth1, 00:00:32
O 10.115.0.0/24 [110/10] is directly connected, eth2, 00:00:25
C>* 10.115.0.0/24 is directly connected, eth2, 00:00:32
O>* 10.135.0.0/24 [110/110] via 10.115.0.1, eth2, label implicit-null, 00:00:15
O>* 10.200.0.0/24 [110/210] via 10.115.0.1, eth2, label 17, 00:00:15
north-vm#

```

## 1.4.4 EIGRP

### DUAL

The *Diffusing Update Algorithm*, a Bellman-Ford based routing algorithm used by EIGRP.

EIGRP – Routing Information Protocol is widely deployed interior gateway routing protocol. EIGRP was developed in the 1990's. EIGRP is a distance-vector protocol and is based on the *DUAL* algorithms. As a distance-vector protocol, the EIGRP router send updates to its neighbors as networks change, thus allowing the convergence to a known topology.

*igrpd* supports EIGRP as described in RFC7868

*igrpd* invocation options. Common options that can be specified (common-invocation-options).

### EIGRP Configuration

#### **router eigrp (1-65535) [vrf NAME]**

The *router eigrp* command is necessary to enable EIGRP. To disable EIGRP, use the *no router eigrp (1-65535)* command. EIGRP must be enabled before carrying out any of the EIGRP commands. Specify vrf NAME if you want eigrp to work within the specified vrf.

#### **no router eigrp (1-65535) [vrf NAME]**

Disable EIGRP.

#### **network NETWORK**

#### **no network NETWORK**

Set the EIGRP enable interface by *network*. The interfaces which have addresses matching with *network* are enabled.

This group of commands either enables or disables EIGRP interfaces between certain numbers of a specified network address. For example, if the network for 10.0.0/24 is EIGRP enabled, this would result in all the addresses from 10.0.0.0 to 10.0.0.255 being enabled for EIGRP. The *no network* command will disable EIGRP for the specified network.

Below is very simple EIGRP configuration. Interface *eth0* and interface which address match to *10.0.0/8* are EIGRP enabled.

```

!
router eigrp 1
 network 10.0.0.0/8
!

```

**passive-interface (IFNAME|default)**

**no passive-interface IFNAME**

This command sets the specified interface to passive mode. On passive mode interface, all receiving packets are ignored and eigrpd does not send either multicast or unicast EIGRP packets except to EIGRP neighbors specified with *neighbor* command. The interface may be specified as *default* to make eigrpd default to passive on all interfaces.

The default is to be passive on all interfaces.

## How to Announce EIGRP route

**redistribute kernel**

**redistribute kernel metric (1-4294967295) (0-4294967295) (0-255) (1-255) (1-65535)**

**no redistribute kernel**

*redistribute kernel* redistributes routing information from kernel route entries into the EIGRP tables. *no redistribute kernel* disables the routes.

**redistribute static**

**redistribute static metric (1-4294967295) (0-4294967295) (0-255) (1-255) (1-65535)**

**no redistribute static**

*redistribute static* redistributes routing information from static route entries into the EIGRP tables. *no redistribute static* disables the routes.

**redistribute connected**

**redistribute connected metric (1-4294967295) (0-4294967295) (0-255) (1-255) (1-65535)**

**no redistribute connected**

Redistribute connected routes into the EIGRP tables. *no redistribute connected* disables the connected routes in the EIGRP tables. This command redistribute connected of the interface which EIGRP disabled. The connected route on EIGRP enabled interface is announced by default.

**redistribute ospf**

**redistribute ospf metric (1-4294967295) (0-4294967295) (0-255) (1-255) (1-65535)**

**no redistribute ospf**

*redistribute ospf* redistributes routing information from ospf route entries into the EIGRP tables. *no redistribute ospf* disables the routes.

**redistribute bgp**

**redistribute bgp metric (1-4294967295) (0-4294967295) (0-255) (1-255) (1-65535)**

**no redistribute bgp**

*redistribute bgp* redistributes routing information from bgp route entries into the EIGRP tables. *no redistribute bgp* disables the routes.



## Show EIGRP Information

### show ip eigrp [vrf NAME] topology

Display current EIGRP status.

```
eigrpd> **show ip eigrp topology**
# show ip eigrp topo

EIGRP Topology Table for AS(4)/ID(0.0.0.0)

Codes: P - Passive, A - Active, U - Update, Q - Query, R - Reply
       r - reply Status, s - sia Status

P 10.0.2.0/24, 1 successors, FD is 256256, serno: 0
   via Connected, enp0s3
```

### show ip eigrp [vrf NAME] interface

Display the list of interfaces associated with a particular eigrp instance.

..index:: show ip eigrp [vrf NAME] neighbor ..clicmd:: show ip eigrp [vrf NAME] neighbor

Display the list of neighbors that have been established within a particular eigrp instance.

## EIGRP Debug Commands

Debug for EIGRP protocol.

### debug eigrp packets

Debug eigrp packets

debug eigrp will show EIGRP packets that are sent and received.

### debug eigrp transmit

Debug eigrp transmit events

debug eigrp transmit will display detailed information about the EIGRP transmit events.

### show debugging eigrp

Display *eigrpd*'s debugging option.

show debugging eigrp will show all information currently set for eigrpd debug.

## 1.4.5 ISIS

ISIS (Intermediate System to Intermediate System) is a routing protocol which is described in *ISO10589*, [RFC 1195](#), [RFC 5308](#). ISIS is an IGP (Interior Gateway Protocol). Compared with RIP, ISIS can provide scalable network support and faster convergence times like OSPF. ISIS is widely used in large networks such as ISP (Internet Service Provider) and carrier backbone networks.

## Configuring isisd

There are no *isisd* specific options. Common options can be specified (common-invocation-options) to *isisd*. *isisd* needs to acquire interface information from *zebra* in order to function. Therefore *zebra* must be running before invoking *isisd*. Also, if *zebra* is restarted then *isisd* must be too.

### ISIS router

To start the ISIS process you have to specify the ISIS router. As of this writing, *isisd* does not support multiple ISIS processes.

**[no] router isis WORD [vrf NAME]**

Enable or disable the ISIS process by specifying the ISIS domain with 'WORD'. *isisd* does not yet support multiple ISIS processes but you must specify the name of ISIS process. The ISIS process name 'WORD' is then used for interface (see command `ip router isis WORD`).

**net XX.XXXX. ... .XXX.XX**

**no net XX.XXXX. ... .XXX.XX**

Set/Unset network entity title (NET) provided in ISO format.

**hostname dynamic**

**no hostname dynamic**

Enable support for dynamic hostname.

**area-password [clear | md5] <password>**

**domain-password [clear | md5] <password>**

**no area-password**

**no domain-password**

Configure the authentication password for an area, respectively a domain, as clear text or md5 one.

**log-adjacency-changes**

**no log-adjacency-changes**

Log changes in adjacency state.

**metric-style [narrow | transition | wide]**

**no metric-style**

Set old-style (ISO 10589) or new-style packet formats:

- narrow Use old style of TLVs with narrow metric
- transition Send and accept both styles of TLVs during transition
- wide Use new style of TLVs to carry wider metric

**set-overload-bit**

**no set-overload-bit**

Set overload bit to avoid any transit traffic.

**purge-originator**

**no purge-originator**

Enable or disable **RFC 6232** purge originator identification.

**[no] lsp-mtu (128-4352)**

Configure the maximum size of generated LSPs, in bytes.

**ISIS Timer****lsp-gen-interval (1-120)****lsp-gen-interval [level-1 | level-2] (1-120)****no lsp-gen-interval****no lsp-gen-interval [level-1 | level-2]**

Set minimum interval in seconds between regenerating same LSP, globally, for an area (level-1) or a domain (level-2).

**lsp-refresh-interval [level-1 | level-2] (1-65235)****no lsp-refresh-interval [level-1 | level-2]**

Set LSP refresh interval in seconds, globally, for an area (level-1) or a domain (level-2).

**max-lsp-lifetime (360-65535)****max-lsp-lifetime [level-1 | level-2] (360-65535)****no max-lsp-lifetime****no max-lsp-lifetime [level-1 | level-2]**

Set LSP maximum LSP lifetime in seconds, globally, for an area (level-1) or a domain (level-2).

**spf-interval (1-120)****spf-interval [level-1 | level-2] (1-120)****no spf-interval****no spf-interval [level-1 | level-2]**

Set minimum interval between consecutive SPF calculations in seconds.

**ISIS region****is-type [level-1 | level-1-2 | level-2-only]****no is-type**

Define the ISIS router behavior:

- level-1 Act as a station router only
- level-1-2 Act as both a station router and an area router
- level-2-only Act as an area router only

## ISIS interface

**[no] <ip|ipv6> router isis WORD [vrf NAME]**

Activate ISIS adjacency on this interface. Note that the name of ISIS instance must be the same as the one used to configure the ISIS process (see command `router isis WORD`). To enable IPv4, issue `ip router isis WORD`; to enable IPv6, issue `ipv6 router isis WORD`.

**isis circuit-type [level-1 | level-1-2 | level-2]**

**no isis circuit-type**

Configure circuit type for interface:

- level-1 Level-1 only adjacencies are formed
- level-1-2 Level-1-2 adjacencies are formed
- level-2-only Level-2 only adjacencies are formed

**isis csnp-interval (1-600)**

**isis csnp-interval (1-600) [level-1 | level-2]**

**no isis csnp-interval**

**no isis csnp-interval [level-1 | level-2]**

Set CSNP interval in seconds globally, for an area (level-1) or a domain (level-2).

**isis hello padding**

Add padding to IS-IS hello packets.

**isis hello-interval (1-600)**

**isis hello-interval (1-600) [level-1 | level-2]**

**no isis hello-interval**

**no isis hello-interval [level-1 | level-2]**

Set Hello interval in seconds globally, for an area (level-1) or a domain (level-2).

**isis hello-multiplier (2-100)**

**isis hello-multiplier (2-100) [level-1 | level-2]**

**no isis hello-multiplier**

**no isis hello-multiplier [level-1 | level-2]**

Set multiplier for Hello holding time globally, for an area (level-1) or a domain (level-2).

**isis metric [(0-255) | (0-16777215)]**

**isis metric [(0-255) | (0-16777215)] [level-1 | level-2]**

**no isis metric**

**no isis metric [level-1 | level-2]**

Set default metric value globally, for an area (level-1) or a domain (level-2). Max value depend if metric support narrow or wide value (see command `metric-style [narrow | transition | wide]`).

**isis network point-to-point**

**no isis network point-to-point**

Set network type to 'Point-to-Point' (broadcast by default).

**isis passive****no isis passive**

Configure the passive mode for this interface.

**isis password [clear | md5] <password>****no isis password**

Configure the authentication password (clear or encoded text) for the interface.

**isis priority (0-127)****isis priority (0-127) [level-1 | level-2]****no isis priority****no isis priority [level-1 | level-2]**

Set priority for Designated Router election, globally, for the area (level-1) or the domain (level-2).

**isis psnp-interval (1-120)****isis psnp-interval (1-120) [level-1 | level-2]****no isis psnp-interval****no isis psnp-interval [level-1 | level-2]**

Set PSNP interval in seconds globally, for an area (level-1) or a domain (level-2).

**isis three-way-handshake****no isis three-way-handshake**

Enable or disable [RFC 5303](#) Three-Way Handshake for P2P adjacencies. Three-Way Handshake is enabled by default.

**Showing ISIS information****show isis summary**

Show summary information about ISIS.

**show isis hostname**

Show information about ISIS node.

**show isis interface****show isis interface detail****show isis interface <interface name>**

Show state and configuration of ISIS specified interface, or all interfaces if no interface is given with or without details.

**show isis neighbor****show isis neighbor <System Id>**

**show isis neighbor detail**

Show state and information of ISIS specified neighbor, or all neighbors if no system id is given with or without details.

**show isis database**

**show isis database [detail]**

**show isis database <LSP id> [detail]**

**show isis database detail <LSP id>**

Show the ISIS database globally, for a specific LSP id without or with details.

**show isis topology**

**show isis topology [level-1|level-2]**

Show topology IS-IS paths to Intermediate Systems, globally, in area (level-1) or domain (level-2).

**show isis route [level-1|level-2]**

Show the ISIS routing table, as determined by the most recent SPF calculation.

## Debugging ISIS

**debug isis adj-packets**

**no debug isis adj-packets**

IS-IS Adjacency related packets.

**debug isis checksum-errors**

**no debug isis checksum-errors**

IS-IS LSP checksum errors.

**debug isis events**

**no debug isis events**

IS-IS Events.

**debug isis local-updates**

**no debug isis local-updates**

IS-IS local update packets.

**debug isis packet-dump**

**no debug isis packet-dump**

IS-IS packet dump.

**debug isis protocol-errors**

**no debug isis protocol-errors**

IS-IS LSP protocol errors.

**debug isis route-events**

**no debug isis route-events**

IS-IS Route related events.

**debug isis snp-packets**

**no debug isis snp-packets**

IS-IS CSNP/PSNP packets.

**debug isis spf-events**

**debug isis spf-statistics**

**debug isis spf-triggers**

**no debug isis spf-events**

**no debug isis spf-statistics**

**no debug isis spf-triggers**

IS-IS Shortest Path First Events, Timing and Statistic Data and triggering events.

**debug isis update-packets**

**no debug isis update-packets**

Update related packets.

**show debugging isis**

Print which ISIS debug level is activate.

## ISIS Configuration Examples

A simple example, with MD5 authentication enabled:

```
!
interface eth0
 ip router isis F00
 isis network point-to-point
 isis circuit-type level-2-only
!
router isis F00
net 47.0023.0000.0000.0000.0000.0000.0000.1900.0004.00
 metric-style wide
 is-type level-2-only
```

### 1.4.6 OSPFv2

OSPF (Open Shortest Path First) version 2 is a routing protocol which is described in [RFC 2328](#). OSPF is an IGP. Compared with RIP, OSPF can provide scalable network support and faster convergence times. OSPF is widely used in large networks such as ISP backbone and enterprise networks.

## OSPF Fundamentals

OSPF is, mostly, a link-state routing protocol. In contrast to distance-vector protocols, such as RIP or BGP, where routers describe available *paths* (i.e. routes) to each other, in link-state protocols routers instead describe the state of their links to their immediate neighbouring routers.

Each router describes their link-state information in a message known as an LSA (Link State Advertisement), which is then propagated through to all other routers in a link-state routing domain, by a process called *flooding*. Each router thus builds up an LSDB (Link State Database) of all the link-state messages. From this collection of LSAs in the LSDB, each router can then calculate the shortest path to any other router, based on some common metric, by using an algorithm such as Edsger Dijkstra's SPF (Shortest Path First) algorithm.

By describing connectivity of a network in this way, in terms of routers and links rather than in terms of the paths through a network, a link-state protocol can use less bandwidth and converge more quickly than other protocols. A link-state protocol need distribute only one link-state message throughout the link-state domain when a link on any single given router changes state, in order for all routers to reconverge on the best paths through the network. In contrast, distance vector protocols can require a progression of different path update messages from a series of different routers in order to converge.

The disadvantage to a link-state protocol is that the process of computing the best paths can be relatively intensive when compared to distance-vector protocols, in which near to no computation need be done other than (potentially) select between multiple routes. This overhead is mostly negligible for modern embedded CPUs, even for networks with thousands of nodes. The primary scaling overhead lies more in coping with the ever greater frequency of LSA updates as the size of a link-state area increases, in managing the LSDB and required flooding.

This section aims to give a distilled, but accurate, description of the more important workings of OSPF which an administrator may need to know to be able best configure and trouble-shoot OSPF.

## OSPF Mechanisms

OSPF defines a range of mechanisms, concerned with detecting, describing and propagating state through a network. These mechanisms will nearly all be covered in greater detail further on. They may be broadly classed as:

### The Hello Protocol

The OSPF Hello protocol allows OSPF to quickly detect changes in two-way reachability between routers on a link. OSPF can additionally avail of other sources of reachability information, such as link-state information provided by hardware, or through dedicated reachability protocols such as BFD.

OSPF also uses the Hello protocol to propagate certain state between routers sharing a link, for example:

- Hello protocol configured state, such as the dead-interval.
- Router priority, for DR/BDR election.
- DR/BDR election results.
- Any optional capabilities supported by each router.

The Hello protocol is comparatively trivial and will not be explored in more detail.



## LSAs

At the heart of OSPF are LSA messages. Despite the name, some LSAs do not, strictly speaking, describe link-state information. Common LSAs describe information such as:

- Routers, in terms of their links.
- Networks, in terms of attached routers.
- Routes, external to a link-state domain:

### External Routes

Routes entirely external to OSPF. Routers originating such routes are known as ASBR (Autonomous-System Border Router) routers.

### Summary Routes

Routes which summarise routing information relating to OSPF areas external to the OSPF link-state area at hand, originated by ABR (Area Boundary Router) routers.

## LSA Flooding

OSPF defines several related mechanisms, used to manage synchronisation of LSDBs between neighbours as neighbours form adjacencies and the propagation, or *flooding* of new or updated LSAs.

## Areas

OSPF provides for the protocol to be broken up into multiple smaller and independent link-state areas. Each area must be connected to a common backbone area by an ABR. These ABR routers are responsible for summarising the link-state routing information of an area into *Summary LSAs*, possibly in a condensed (i.e. aggregated) form, and then originating these summaries into all other areas the ABR is connected to.

Note that only summaries and external routes are passed between areas. As these describe *paths*, rather than any router link-states, routing between areas hence is by distance-vector, **not** link-state.

## OSPF LSAs

The core objects in OSPF are LSAs. Everything else in OSPF revolves around detecting what to describe in LSAs, when to update them, how to flood them throughout a network and how to calculate routes from them.

There are a variety of different LSAs, for purposes such as describing actual link-state information, describing paths (i.e. routes), describing bandwidth usage of links for TE (Traffic Engineering) purposes, and even arbitrary data by way of *Opaque* LSAs.

## LSA Header

All LSAs share a common header with the following information:

- Type
  - Different types of LSAs describe different things in OSPF. Types include:
    - Router LSA
    - Network LSA
    - Network Summary LSA

- Router Summary LSA
- AS-External LSA

The specifics of the different types of LSA are examined below.

- Advertising Router

The Router ID of the router originating the LSA.

### See also:

*ospf router-id A.B.C.D.*

- LSA ID

The ID of the LSA, which is typically derived in some way from the information the LSA describes, e.g. a Router LSA uses the Router ID as the LSA ID, a Network LSA will have the IP address of the DR as its LSA ID.

The combination of the Type, ID and Advertising Router ID must uniquely identify the LSA. There can however be multiple instances of an LSA with the same Type, LSA ID and Advertising Router ID, see *sequence number*.

- Age

A number to allow stale LSA s to, eventually, be purged by routers from their LSDB s.

The value nominally is one of seconds. An age of 3600, i.e. 1 hour, is called the *MaxAge*. MaxAge LSAs are ignored in routing calculations. LSAs must be periodically refreshed by their Advertising Router before reaching MaxAge if they are to remain valid.

Routers may deliberately flood LSAs with the age artificially set to 3600 to indicate an LSA is no longer valid. This is called *flushing* of an LSA.

It is not abnormal to see stale LSAs in the LSDB, this can occur where a router has shutdown without flushing its LSA(s), e.g. where it has become disconnected from the network. Such LSAs do little harm.

- Sequence Number

A number used to distinguish newer instances of an LSA from older instances.

## Link-State LSAs

Of all the various kinds of LSA s, just two types comprise the actual link-state part of OSPF, Router LSA s and Network LSA s. These LSA types are absolutely core to the protocol.

Instances of these LSAs are specific to the link-state area in which they are originated. Routes calculated from these two LSA types are called *intra-area routes*.

- Router LSA

Each OSPF Router must originate a router LSA to describe itself. In it, the router lists each of its OSPF enabled interfaces, for the given link-state area, in terms of:

### Cost

The output cost of that interface, scaled inversely to some commonly known reference value, *auto-cost reference-bandwidth (1-4294967)*.

### Link Type

Transit Network

A link to a multi-access network, on which the router has at least one Full adjacency with another router.

**PtP (Point-to-Point)**

A link to a single remote router, with a Full adjacency. No DR (Designated Router) is elected on such links; no network LSA is originated for such a link.

**Stub**

A link with no adjacent neighbours, or a host route.

- Link ID and Data

These values depend on the Link Type:

Link Type	Link ID	Link Data
Transit	Link IP address of the DR	Interface IP address
Point-to-Point	Router ID of the remote router	Local interface IP address, or the IFINDEX (MIB-II interface index) for unnumbered links
Stub	IP address	Subnet Mask

Links on a router may be listed multiple times in the Router LSA, e.g. a PtP interface on which OSPF is enabled must *always* be described by a Stub link in the Router LSA, in addition to being listed as PtP link in the Router LSA if the adjacency with the remote router is Full.

Stub links may also be used as a way to describe links on which OSPF is *not* spoken, known as *passive interfaces*, see [passive-interface INTERFACE](#).

- Network LSA

On multi-access links (e.g. ethernet, certain kinds of ATM and X.25 configurations), routers elect a DR. The DR is responsible for originating a Network LSA, which helps reduce the information needed to describe multi-access networks with multiple routers attached. The DR also acts as a hub for the flooding of LSAs on that link, thus reducing flooding overheads.

The contents of the Network LSA describes the:

- Subnet Mask

As the LSA ID of a Network LSA must be the IP address of the DR, the Subnet Mask together with the LSA ID gives you the network address.

- Attached Routers

Each router fully-adjacent with the DR is listed in the LSA, by their Router-ID. This allows the corresponding Router LSAs to be easily retrieved from the LSDB.

Summary of Link State LSAs:

LSA Type	LSA ID	LSA Data Describes
Router LSA	Router ID	The OSPF enabled links of the router, within a specific link-state area.
Network LSA	The IP address of the DR for the network	The subnet mask of the network and the Router IDs of all routers on the network

With an LSDB composed of just these two types of LSA, it is possible to construct a directed graph of the connectivity between all routers and networks in a given OSPF link-state area. So, not surprisingly, when OSPF routers build updated routing tables, the first stage of SPF calculation concerns itself only with these two LSA types.

## Link-State LSA Examples

The example below shows two LSAs, both originated by the same router (Router ID 192.168.0.49) and with the same LSA ID (192.168.0.49), but of different LSA types.

The first LSA being the router LSA describing 192.168.0.49's links: 2 links to multi-access networks with fully-adjacent neighbours (i.e. Transit links) and 1 being a Stub link (no adjacent neighbours).

The second LSA being a Network LSA, for which 192.168.0.49 is the DR, listing the Router IDs of 4 routers on that network which are fully adjacent with 192.168.0.49.

```
# show ip ospf database router 192.168.0.49

    OSPF Router with ID (192.168.0.53)

          Router Link States (Area 0.0.0.0)

LS age: 38
Options: 0x2 : *|---|---|E|*
LS Flags: 0x6
Flags: 0x2 : ASBR
LS Type: router-LSA
Link State ID: 192.168.0.49
Advertising Router: 192.168.0.49
LS Seq Number: 80000f90
Checksum: 0x518b
Length: 60
  Number of Links: 3

    Link connected to: a Transit Network
      (Link ID) Designated Router address: 192.168.1.3
      (Link Data) Router Interface address: 192.168.1.3
      Number of TOS metrics: 0
      TOS 0 Metric: 10

    Link connected to: a Transit Network
      (Link ID) Designated Router address: 192.168.0.49
      (Link Data) Router Interface address: 192.168.0.49
      Number of TOS metrics: 0
      TOS 0 Metric: 10

    Link connected to: Stub Network
      (Link ID) Net: 192.168.3.190
      (Link Data) Network Mask: 255.255.255.255
      Number of TOS metrics: 0
      TOS 0 Metric: 39063
# show ip ospf database network 192.168.0.49

    OSPF Router with ID (192.168.0.53)

          Net Link States (Area 0.0.0.0)

LS age: 285
Options: 0x2 : *|---|---|E|*
```

(continues on next page)

(continued from previous page)

```

LS Flags: 0x6
LS Type: network-LSA
Link State ID: 192.168.0.49 (address of Designated Router)
Advertising Router: 192.168.0.49
LS Seq Number: 80000074
Checksum: 0x0103
Length: 40
Network Mask: /29
  Attached Router: 192.168.0.49
  Attached Router: 192.168.0.52
  Attached Router: 192.168.0.53
  Attached Router: 192.168.0.54

```

Note that from one LSA, you can find the other. E.g. Given the Network-LSA you have a list of Router IDs on that network, from which you can then look up, in the local LSDB, the matching Router LSA. From that Router-LSA you may (potentially) find links to other Transit networks and Routers IDs which can be used to lookup the corresponding Router or Network LSA. And in that fashion, one can find all the Routers and Networks reachable from that starting LSA.

Given the Router LSA instead, you have the IP address of the DR of any attached transit links. Network LSAs will have that IP as their LSA ID, so you can then look up that Network LSA and from that find all the attached routers on that link, leading potentially to more links and Network and Router LSAs, etc. etc.

From just the above two LSA s, one can already see the following partial topology:

```

----- Network: .....
          |
          | Designated Router IP: 192.168.1.3
          |
          | IP: 192.168.1.3
          | (transit link)
          | (cost: 10)
          | Router ID: 192.168.0.49(stub)----- IP: 192.168.3.190/32
          | (cost: 10) (cost: 39063)
          | (transit link)
          | IP: 192.168.0.49
          |
          |----- Network: 192.168.0.48/29
          | Designated Router IP: 192.168.0.49
          |
          | Router ID: 192.168.0.54
          |
          | Router ID: 192.168.0.53
          |
          | Router ID: 192.168.0.52

```

Note the Router IDs, though they look like IP addresses and often are IP addresses, are not strictly speaking IP addresses, nor need they be reachable addresses (though, OSPF will calculate routes to Router IDs).

## External LSAs

External, or “Type 5”, LSAs describe routing information which is entirely external to OSPF, and is “injected” into OSPF. Such routing information may have come from another routing protocol, such as RIP or BGP, they may represent static routes or they may represent a default route.

An OSPF router which originates External LSAs is known as an ASBR. Unlike the link-state LSAs, and most other LSAs, which are flooded only within the area in which they originate, External LSAs are flooded through-out the OSPF network to all areas capable of carrying External LSAs (*Areas*).

Routes internal to OSPF (intra-area or inter-area) are always preferred over external routes.

The External LSA describes the following:

### IP Network number

The IP Network number of the route is described by the LSA ID field.

### IP Network Mask

The body of the External LSA describes the IP Network Mask of the route. This, together with the LSA ID, describes the prefix of the IP route concerned.

### Metric

The cost of the External Route. This cost may be an OSPF cost (also known as a “Type 1” metric), i.e. equivalent to the normal OSPF costs, or an externally derived cost (“Type 2” metric) which is not comparable to OSPF costs and always considered larger than any OSPF cost. Where there are both Type 1 and 2 External routes for a route, the Type 1 is always preferred.

### Forwarding Address

The address of the router to forward packets to for the route. This may be, and usually is, left as 0 to specify that the ASBR originating the External LSA should be used. There must be an internal OSPF route to the forwarding address, for the forwarding address to be usable.

### Tag

An arbitrary 4-bytes of data, not interpreted by OSPF, which may carry whatever information about the route which OSPF speakers desire.

## AS External LSA Example

To illustrate, below is an example of an External LSA in the LSDB of an OSPF router. It describes a route to the IP prefix of 192.168.165.0/24, originated by the ASBR with Router-ID 192.168.0.49. The metric of 20 is external to OSPF. The forwarding address is 0, so the route should forward to the originating ASBR if selected.

```
# show ip ospf database external 192.168.165.0
LS age: 995
Options: 0x2 : *|---|---|E|*
LS Flags: 0x9
LS Type: AS-external-LSA
Link State ID: 192.168.165.0 (External Network Number)
Advertising Router: 192.168.0.49
LS Seq Number: 800001d8
Checksum: 0xea27
Length: 36
Network Mask: /24
    Metric Type: 2 (Larger than any link state path)
    TOS: 0
    Metric: 20
```

(continues on next page)

(continued from previous page)

```
Forward Address: 0.0.0.0
External Route Tag: 0
```

We can add this to our partial topology from above, which now looks like::

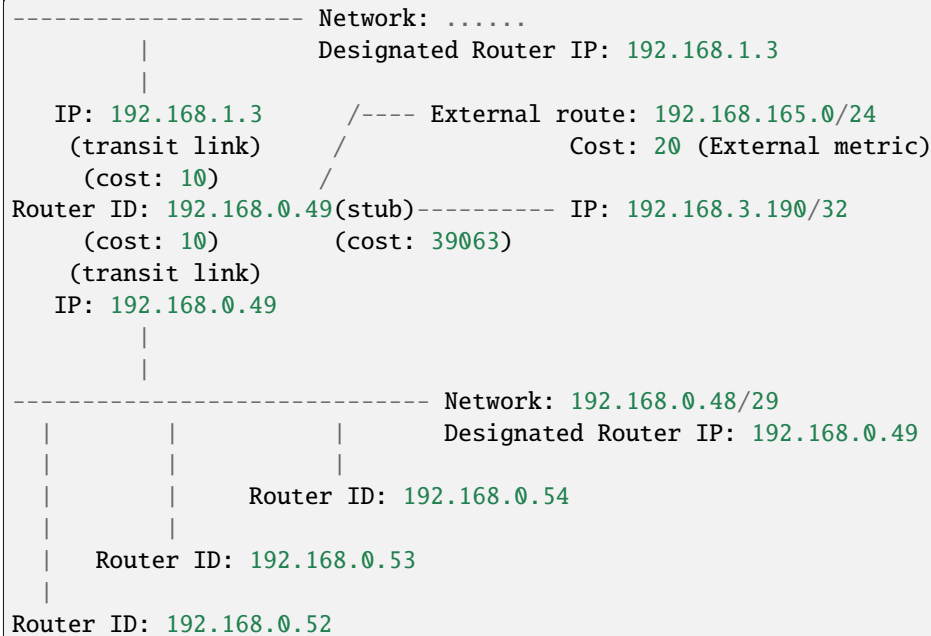

## Summary LSAs

Summary LSAs are created by ABR s to summarise the destinations available within one area to other areas. These LSAs may describe IP networks, potentially in aggregated form, or ASBR routers.

## Routers

To start OSPF process you have to specify the OSPF router.

```
router ospf [(1-65535)] vrf NAME
```

```
no router ospf [(1-65535)] vrf NAME
```

Enable or disable the OSPF process.

```
ospf router-id A.B.C.D
```

```
no ospf router-id [A.B.C.D]
```

This sets the router-ID of the OSPF process. The router-ID may be an IP address of the router, but need not be - it can be any arbitrary 32bit number. However it **MUST** be unique within the entire OSPF domain to the OSPF speaker - bad things will happen if multiple OSPF speakers are configured with the same router-ID! If one is not specified then *ospfd* will obtain a router-ID automatically from *zebra*.

```
ospf abr-type TYPE
```

**no ospf abr-type TYPE**

*type* can be cisco|ibm|shortcut|standard. The “Cisco” and “IBM” types are equivalent.

The OSPF standard for ABR behaviour does not allow an ABR to consider routes through non-backbone areas when its links to the backbone are down, even when there are other ABRs in attached non-backbone areas which still can reach the backbone - this restriction exists primarily to ensure routing-loops are avoided.

With the “Cisco” or “IBM” ABR type, the default in this release of FRR, this restriction is lifted, allowing an ABR to consider summaries learned from other ABRs through non-backbone areas, and hence route via non-backbone areas as a last resort when, and only when, backbone links are down.

Note that areas with fully-adjacent virtual-links are considered to be “transit capable” and can always be used to route backbone traffic, and hence are unaffected by this setting (*area A.B.C.D virtual-link A.B.C.D*).

More information regarding the behaviour controlled by this command can be found in [RFC 3509](#), and *draft-ietf-ospf-shortcut-abr-02.txt*.

Quote: “Though the definition of the ABR in the OSPF specification does not require a router with multiple attached areas to have a backbone connection, it is actually necessary to provide successful routing to the inter-area and external destinations. If this requirement is not met, all traffic destined for the areas not connected to such an ABR or out of the OSPF domain, is dropped. This document describes alternative ABR behaviors implemented in Cisco and IBM routers.”

**ospf rfc1583compatibility**

**no ospf rfc1583compatibility**

[RFC 2328](#), the successor to [RFC 1583](#), suggests according to section G.2 (changes) in section 16.4 a change to the path preference algorithm that prevents possible routing loops that were possible in the old version of OSPFv2. More specifically it demands that inter-area paths and intra-area backbone path are now of equal preference but still both preferred to external paths.

This command should NOT be set normally.

**log-adjacency-changes [detail]**

**no log-adjacency-changes [detail]**

Configures ospfd to log changes in adjacency. With the optional detail argument, all changes in adjacency status are shown. Without detail, only changes to full or regressions are shown.

**passive-interface INTERFACE**

**no passive-interface INTERFACE**

Do not speak OSPF interface on the given interface, but do advertise the interface as a stub link in the router-LSA for this router. This allows one to advertise addresses on such connected interfaces without having to originate AS-External/Type-5 LSAs (which have global flooding scope) - as would occur if connected addresses were redistributed into OSPF (*Redistribution*). This is the only way to advertise non-OSPF links into stub areas.

**timers throttle spf (0-600000) (0-600000) (0-600000)**

**no timers throttle spf**

This command sets the initial *delay*, the *initial-holdtime* and the *maximum-holdtime* between when SPF is calculated and the event which triggered the calculation. The times are specified in milliseconds and must be in the range of 0 to 600000 milliseconds.

The *delay* specifies the minimum amount of time to delay SPF calculation (hence it affects how long SPF calculation is delayed after an event which occurs outside of the holdtime of any previous SPF calculation, and also serves as a minimum holdtime).

Consecutive SPF calculations will always be separated by at least ‘hold-time’ milliseconds. The hold-time is adaptive and initially is set to the *initial-holdtime* configured with the above command. Events which occur



within the holdtime of the previous SPF calculation will cause the holdtime to be increased by *initial-holdtime*, bounded by the *maximum-holdtime* configured with this command. If the adaptive hold-time elapses without any SPF-triggering event occurring then the current holdtime is reset to the *initial-holdtime*. The current holdtime can be viewed with `show ip ospf`, where it is expressed as a multiplier of the *initial-holdtime*.

```
router ospf
timers throttle spf 200 400 10000
```

In this example, the *delay* is set to 200ms, the initial holdtime is set to 400ms and the *maximum holdtime* to 10s. Hence there will always be at least 200ms between an event which requires SPF calculation and the actual SPF calculation. Further consecutive SPF calculations will always be separated by between 400ms to 10s, the hold-time increasing by 400ms each time an SPF-triggering event occurs within the hold-time of the previous SPF calculation.

This command supersedes the `timers spf` command in previous FRR releases.

**max-metric router-lsa [on-startup|on-shutdown] (5-86400)**

**max-metric router-lsa administrative**

**no max-metric router-lsa [on-startup|on-shutdown|administrative]**

This enables [RFC 3137](#) support, where the OSPF process describes its transit links in its router-LSA as having infinite distance so that other routers will avoid calculating transit paths through the router while still being able to reach networks through the router.

This support may be enabled administratively (and indefinitely) or conditionally. Conditional enabling of max-metric router-lsas can be for a period of seconds after startup and/or for a period of seconds prior to shutdown.

Enabling this for a period after startup allows OSPF to converge fully first without affecting any existing routes used by other routers, while still allowing any connected stub links and/or redistributed routes to be reachable. Enabling this for a period of time in advance of shutdown allows the router to gracefully excuse itself from the OSPF domain.

Enabling this feature administratively allows for administrative intervention for whatever reason, for an indefinite period of time. Note that if the configuration is written to file, this administrative form of the stub-router command will also be written to file. If `ospfd` is restarted later, the command will then take effect until manually deconfigured.

Configured state of this feature as well as current status, such as the number of second remaining till on-startup or on-shutdown ends, can be viewed with the `show ip ospf` command.

**auto-cost reference-bandwidth (1-4294967)**

**no auto-cost reference-bandwidth**

This sets the reference bandwidth for cost calculations, where this bandwidth is considered equivalent to an OSPF cost of 1, specified in Mbits/s. The default is 100Mbit/s (i.e. a link of bandwidth 100Mbit/s or higher will have a cost of 1. Cost of lower bandwidth links will be scaled with reference to this cost).

This configuration setting **MUST** be consistent across all routers within the OSPF domain.

**network A.B.C.D/M area A.B.C.D**

**network A.B.C.D/M area (0-4294967295)**

**no network A.B.C.D/M area A.B.C.D**

**no network A.B.C.D/M area (0-4294967295)**

This command specifies the OSPF enabled interface(s). If the interface has an address from range 192.168.1.0/24 then the command below enables ospf on this interface so router can provide network information to the other ospf routers via this interface.

```
router ospf
network 192.168.1.0/24 area 0.0.0.0
```

Prefix length in interface must be equal or bigger (i.e. smaller network) than prefix length in network statement. For example statement above doesn't enable ospf on interface with address 192.168.1.1/23, but it does on interface with address 192.168.1.129/25.

Note that the behavior when there is a peer address defined on an interface changed after release 0.99.7. Currently, if a peer prefix has been configured, then we test whether the prefix in the network command contains the destination prefix. Otherwise, we test whether the network command prefix contains the local address prefix of the interface.

In some cases it may be more convenient to enable OSPF on a per interface/subnet basis (*ip ospf area AREA [ADDR]*).

### **proactive-arp**

#### **no proactive-arp**

This command enables or disables sending ARP requests to update neighbor table entries. It speeds up convergence for /32 networks on a P2P connection.

This feature is enabled by default.

## **Areas**

**area A.B.C.D range A.B.C.D/M**

**area (0-4294967295) range A.B.C.D/M**

**no area A.B.C.D range A.B.C.D/M**

**no area (0-4294967295) range A.B.C.D/M**

Summarize intra area paths from specified area into one Type-3 summary-LSA announced to other areas. This command can be used only in ABR and ONLY router-LSAs (Type-1) and network-LSAs (Type-2) (i.e. LSAs with scope area) can be summarized. Type-5 AS-external-LSAs can't be summarized - their scope is AS. Summarizing Type-7 AS-external-LSAs isn't supported yet by FRR.

```
router ospf
network 192.168.1.0/24 area 0.0.0.0
network 10.0.0.0/8 area 0.0.0.10
area 0.0.0.10 range 10.0.0.0/8
```

With configuration above one Type-3 Summary-LSA with routing info 10.0.0.0/8 is announced into backbone area if area 0.0.0.10 contains at least one intra-area network (i.e. described with router or network LSA) from this range.

**area A.B.C.D range IPV4\_PREFIX not-advertise**

**no area A.B.C.D range IPV4\_PREFIX not-advertise**

Instead of summarizing intra area paths filter them - i.e. intra area paths from this range are not advertised into other areas. This command makes sense in ABR only.

**area A.B.C.D range IPV4\_PREFIX substitute IPV4\_PREFIX**

**no area A.B.C.D range IPV4\_PREFIX substitute IPV4\_PREFIX**

Substitute summarized prefix with another prefix.

```
router ospf
network 192.168.1.0/24 area 0.0.0.0
network 10.0.0.0/8 area 0.0.0.10
area 0.0.0.10 range 10.0.0.0/8 substitute 11.0.0.0/8
```

One Type-3 summary-LSA with routing info 11.0.0.0/8 is announced into backbone area if area 0.0.0.10 contains at least one intra-area network (i.e. described with router-LSA or network-LSA) from range 10.0.0.0/8. This command makes sense in ABR only.

**area A.B.C.D virtual-link A.B.C.D**

**area (0-4294967295) virtual-link A.B.C.D**

**no area A.B.C.D virtual-link A.B.C.D**

**no area (0-4294967295) virtual-link A.B.C.D**

**area A.B.C.D shortcut**

**area (0-4294967295) shortcut**

**no area A.B.C.D shortcut**

**no area (0-4294967295) shortcut**

Configure the area as Shortcut capable. See [RFC 3509](#). This requires that the 'abr-type' be set to 'shortcut'.

**area A.B.C.D stub**

**area (0-4294967295) stub**

**no area A.B.C.D stub**

**no area (0-4294967295) stub**

Configure the area to be a stub area. That is, an area where no router originates routes external to OSPF and hence an area where all external routes are via the ABR(s). Hence, ABRs for such an area do not need to pass AS-External LSAs (type-5s) or ASBR-Summary LSAs (type-4) into the area. They need only pass Network-Summary (type-3) LSAs into such an area, along with a default-route summary.

**area A.B.C.D stub no-summary**

**area (0-4294967295) stub no-summary**

**no area A.B.C.D stub no-summary**

**no area (0-4294967295) stub no-summary**

Prevents an *ospfd* ABR from injecting inter-area summaries into the specified stub area.

**area A.B.C.D default-cost (0-16777215)**

**no area A.B.C.D default-cost (0-16777215)**

Set the cost of default-summary LSAs announced to stubby areas.

**area A.B.C.D export-list NAME**

**area (0-4294967295) export-list NAME**

**no area A.B.C.D export-list NAME**

**no area (0-4294967295) export-list NAME**

Filter Type-3 summary-LSAs announced to other areas originated from intra- area paths from specified area.

```
router ospf
network 192.168.1.0/24 area 0.0.0.0
network 10.0.0.0/8 area 0.0.0.10
area 0.0.0.10 export-list foo
!
access-list foo permit 10.10.0.0/16
access-list foo deny any
```

With example above any intra-area paths from area 0.0.0.10 and from range 10.10.0.0/16 (for example 10.10.1.0/24 and 10.10.2.128/30) are announced into other areas as Type-3 summary-LSA's, but any others (for example 10.11.0.0/16 or 10.128.30.16/30) aren't.

This command is only relevant if the router is an ABR for the specified area.

**area A.B.C.D import-list NAME**

**area (0-4294967295) import-list NAME**

**no area A.B.C.D import-list NAME**

**no area (0-4294967295) import-list NAME**

Same as export-list, but it applies to paths announced into specified area as Type-3 summary-LSAs.

**area A.B.C.D filter-list prefix NAME in**

**area A.B.C.D filter-list prefix NAME out**

**area (0-4294967295) filter-list prefix NAME in**

**area (0-4294967295) filter-list prefix NAME out**

**no area A.B.C.D filter-list prefix NAME in**

**no area A.B.C.D filter-list prefix NAME out**

**no area (0-4294967295) filter-list prefix NAME in**

**no area (0-4294967295) filter-list prefix NAME out**

Filtering Type-3 summary-LSAs to/from area using prefix lists. This command makes sense in ABR only.

**area A.B.C.D authentication**

**area (0-4294967295) authentication**

**no area A.B.C.D authentication**

**no area (0-4294967295) authentication**

Specify that simple password authentication should be used for the given area.

**area A.B.C.D authentication message-digest**

**area (0-4294967295) authentication message-digest**

Specify that OSPF packets must be authenticated with MD5 HMACs within the given area. Keying material must also be configured on a per-interface basis (`ip ospf message-digest-key`).

MD5 authentication may also be configured on a per-interface basis (`ip ospf authentication message-digest`). Such per-interface settings will override any per-area authentication setting.

**Interfaces****ip ospf area AREA [ADDR]****no ip ospf area [ADDR]**

Enable OSPF on the interface, optionally restricted to just the IP address given by *ADDR*, putting it in the *AREA* area. Per interface area settings take precedence to network commands (`network A.B.C.D/M area A.B.C.D`).

If you have a lot of interfaces, and/or a lot of subnets, then enabling OSPF via this command may result in a slight performance improvement.

**ip ospf authentication-key AUTH\_KEY****no ip ospf authentication-key**

Set OSPF authentication key to a simple password. After setting *AUTH\_KEY*, all OSPF packets are authenticated. *AUTH\_KEY* has length up to 8 chars.

Simple text password authentication is insecure and deprecated in favour of MD5 HMAC authentication.

**ip ospf authentication message-digest**

Specify that MD5 HMAC authentication must be used on this interface. MD5 keying material must also be configured. Overrides any authentication enabled on a per-area basis (`area A.B.C.D authentication message-digest`)

Note that OSPF MD5 authentication requires that time never go backwards (correct time is NOT important, only that it never goes backwards), even across resets, if `ospfd` is to be able to promptly reestablish adjacencies with its neighbours after restarts/reboots. The host should have system time be set at boot from an external or non-volatile source (e.g. battery backed clock, NTP, etc.) or else the system clock should be periodically saved to non-volatile storage and restored at boot if MD5 authentication is to be expected to work reliably.

**ip ospf message-digest-key KEYID md5 KEY****no ip ospf message-digest-key**

Set OSPF authentication key to a cryptographic password. The cryptographic algorithm is MD5.

KEYID identifies secret key used to create the message digest. This ID is part of the protocol and must be consistent across routers on a link.

KEY is the actual message digest key, of up to 16 chars (larger strings will be truncated), and is associated with the given KEYID.

**ip ospf cost (1-65535)****no ip ospf cost**

Set link cost for the specified interface. The cost value is set to router-LSA's metric field and used for SPF calculation.

**ip ospf dead-interval (1-65535)**

**ip ospf dead-interval minimal hello-multiplier (2-20)**

**no ip ospf dead-interval**

Set number of seconds for RouterDeadInterval timer value used for Wait Timer and Inactivity Timer. This value must be the same for all routers attached to a common network. The default value is 40 seconds.

If 'minimal' is specified instead, then the dead-interval is set to 1 second and one must specify a hello-multiplier. The hello-multiplier specifies how many Hellos to send per second, from 2 (every 500ms) to 20 (every 50ms). Thus one can have 1s convergence time for OSPF. If this form is specified, then the hello-interval advertised in Hello packets is set to 0 and the hello-interval on received Hello packets is not checked, thus the hello-multiplier need NOT be the same across multiple routers on a common link.

**ip ospf hello-interval (1-65535)**

**no ip ospf hello-interval**

Set number of seconds for HelloInterval timer value. Setting this value, Hello packet will be sent every timer value seconds on the specified interface. This value must be the same for all routers attached to a common network. The default value is 10 seconds.

This command has no effect if *ip ospf dead-interval minimal hello-multiplier (2-20)* is also specified for the interface.

**ip ospf network (broadcast|non-broadcast|point-to-multipoint|point-to-point)**

When configuring a point-to-point network on an interface and the interface has a /32 address associated with then OSPF will treat the interface as being *unnumbered*.

**no ip ospf network**

Set explicitly network type for specified interface.

**ip ospf priority (0-255)**

**no ip ospf priority**

Set RouterPriority integer value. The router with the highest priority will be more eligible to become Designated Router. Setting the value to 0, makes the router ineligible to become Designated Router. The default value is 1.

**ip ospf retransmit-interval (1-65535)**

**no ip ospf retransmit interval**

Set number of seconds for RxmtInterval timer value. This value is used when retransmitting Database Description and Link State Request packets. The default value is 5 seconds.

**ip ospf transmit-delay (1-65535) [A.B.C.D]**

**no ip ospf transmit-delay [(1-65535)] [A.B.C.D]**

Set number of seconds for InfTransDelay value. LSAs' age should be incremented by this value when transmitting. The default value is 1 second.

**ip ospf area (A.B.C.D|(0-4294967295))**

**no ip ospf area**

Enable ospf on an interface and set associated area.

## OSPF route-map

Usage of *ospfd*'s route-map support.

**set metric [+|-](0-4294967295)**

Set a metric for matched route when sending announcement. Use plus (+) sign to add a metric value to an existing metric. Use minus (-) sign to subtract a metric value from an existing metric.

## Redistribution

**redistribute (kernel|connected|static|rip|bgp)**

**redistribute (kernel|connected|static|rip|bgp) ROUTE-MAP**

**redistribute (kernel|connected|static|rip|bgp) metric-type (1|2)**

**redistribute (kernel|connected|static|rip|bgp) metric-type (1|2) route-map WORD**

**redistribute (kernel|connected|static|rip|bgp) metric (0-16777214)**

**redistribute (kernel|connected|static|rip|bgp) metric (0-16777214) route-map WORD**

**redistribute (kernel|connected|static|rip|bgp) metric-type (1|2) metric (0-16777214)**

**redistribute (kernel|connected|static|rip|bgp) metric-type (1|2) metric (0-16777214) route-map WORD**

**no redistribute (kernel|connected|static|rip|bgp)**

Redistribute routes of the specified protocol or kind into OSPF, with the metric type and metric set if specified, filtering the routes using the given route-map if specified. Redistributed routes may also be filtered with distribute-lists, see *ospf distribute-list configuration*.

Redistributed routes are distributed as into OSPF as Type-5 External LSAs into links to areas that accept external routes, Type-7 External LSAs for NSSA areas and are not redistributed at all into Stub areas, where external routes are not permitted.

Note that for connected routes, one may instead use the *passive-interface* configuration.

### See also:

*clcmd:passive-interface INTERFACE*.

**default-information originate**

**default-information originate metric (0-16777214)**

**default-information originate metric (0-16777214) metric-type (1|2)**

**default-information originate metric (0-16777214) metric-type (1|2) route-map WORD**

**default-information originate always**

**default-information originate always metric (0-16777214)**

**default-information originate always metric (0-16777214) metric-type (1|2)**

**default-information originate always metric (0-16777214) metric-type (1|2) route-map WORD**

**no default-information originate**

Originate an AS-External (type-5) LSA describing a default route into all external-routing capable areas, of the specified metric and metric type. If the 'always' keyword is given then the default is always advertised, even when there is no default present in the routing table.

**distribute-list NAME out (kernel|connected|static|rip|ospf**

**no distribute-list NAME out (kernel|connected|static|rip|ospf**

Apply the access-list filter, NAME, to redistributed routes of the given type before allowing the routes to be redistributed into OSPF (*ospf redistribution*).

**default-metric (0-16777214)**

**no default-metric**

**distance (1-255)**

**no distance (1-255)**

**distance ospf (intra-area|inter-area|external) (1-255)**

**no distance ospf**

**router zebra**

**no router zebra**

## Showing Information

**show ip ospf**

Show information on a variety of general OSPF and area state and configuration information.

**show ip ospf interface [INTERFACE]**

Show state and configuration of OSPF on the specified interface, or all interfaces if no interface is given.

**show ip ospf neighbor**

**show ip ospf neighbor INTERFACE**

**show ip ospf neighbor detail**

**show ip ospf neighbor INTERFACE detail**

**show ip ospf database**

**show ip ospf database (asbr-summary|external|network|router|summary)**

**show ip ospf database (asbr-summary|external|network|router|summary) LINK-STATE-ID**

**show ip ospf database (asbr-summary|external|network|router|summary) LINK-STATE-ID adv-router ADV-ROUTER**

**show ip ospf database (asbr-summary|external|network|router|summary) adv-router ADV-ROUTER**

**show ip ospf database (asbr-summary|external|network|router|summary) LINK-STATE-ID self-originate**

**show ip ospf database (asbr-summary|external|network|router|summary) self-originate**

**show ip ospf database max-age**



**show ip ospf database self-originate**

**show ip ospf route**

Show the OSPF routing table, as determined by the most recent SPF calculation.

### Opaque LSA

**ospf opaque-lsa**

**capability opaque**

**no ospf opaque-lsa**

**no capability opaque**

**show ip ospf database (opaque-link|opaque-area|opaque-external)**

**show ip ospf database (opaque-link|opaque-area|opaque-external) LINK-STATE-ID**

**show ip ospf database (opaque-link|opaque-area|opaque-external) LINK-STATE-ID adv-router ADV-ROUTER**

**show ip ospf database (opaque-link|opaque-area|opaque-external) adv-router ADV-ROUTER**

**show ip ospf database (opaque-link|opaque-area|opaque-external) LINK-STATE-ID self-originate**

**show ip ospf database (opaque-link|opaque-area|opaque-external) self-originate**

Show Opaque LSA from the database.

### Router Information

**router-info [as | area]**

**no router-info**

Enable Router Information ([RFC 4970](#)) LSA advertisement with AS scope (default) or Area scope flooding when area is specified. Old syntax *router-info area <A.B.C.D>* is always supported but mark as deprecated as the area ID is no more necessary. Indeed, router information support multi-area and detect automatically the areas.

**pce address <A.B.C.D>**

**no pce address**

**pce domain as (0-65535)**

**no pce domain as (0-65535)**

**pce neighbor as (0-65535)**

**no pce neighbor as (0-65535)**

**pce flag BITPATTERN**

**no pce flag**

**pce scope BITPATTERN**

**no pce scope**

The commands are conform to [RFC 5088](#) and allow OSPF router announce Path Computation Element (PCE) capabilities through the Router Information (RI) LSA. Router Information must be enable prior to this. The command set/unset respectively the PCE IP address, Autonomous System (AS) numbers of controlled domains, neighbor ASs, flag and scope. For flag and scope, please refer to :rfc`5088` for the BITPATTERN recognition. Multiple 'pce neighbor' command could be specified in order to specify all PCE neighbours.

**show ip ospf router-info**

Show Router Capabilities flag.

**show ip ospf router-info pce**

Show Router Capabilities PCE parameters.

## Debugging OSPF

**debug ospf packet (hello|dd|ls-request|ls-update|ls-ack|all) (send|rcv) [detail]**

**no debug ospf packet (hello|dd|ls-request|ls-update|ls-ack|all) (send|rcv) [detail]**

Dump Packet for debugging

**debug ospf ism**

**debug ospf ism (status|events|timers)**

**no debug ospf ism**

**no debug ospf ism (status|events|timers)**

Show debug information of Interface State Machine

**debug ospf nsm**

**debug ospf nsm (status|events|timers)**

**no debug ospf nsm**

**no debug ospf nsm (status|events|timers)**

Show debug information of Network State Machine

**debug ospf event**

**no debug ospf event**

Show debug information of OSPF event

**debug ospf nssa**

**no debug ospf nssa**

Show debug information about Not So Stub Area

**debug ospf lsa**

**debug ospf lsa (generate|flooding|refresh)**

**no debug ospf lsa**

**no debug ospf lsa (generate|flooding|refresh)**

Show debug detail of Link State messages

```

debug ospf zebra
debug ospf zebra (interface|redistribute)
no debug ospf zebra
no debug ospf zebra (interface|redistribute)
    Show debug information of ZEBRA API
show debugging ospf

```

## OSPF Configuration Examples

A simple example, with MD5 authentication enabled:

```

!
interface bge0
 ip ospf authentication message-digest
 ip ospf message-digest-key 1 md5 ABCDEFGHIJK
!
router ospf
 network 192.168.0.0/16 area 0.0.0.1
 area 0.0.0.1 authentication message-digest

```

An ABR router, with MD5 authentication and performing summarisation of networks between the areas:

```

!
log syslog
!
interface eth0
 ip ospf authentication message-digest
 ip ospf message-digest-key 1 md5 ABCDEFGHIJK
!
interface ppp0
!
interface br0
 ip ospf authentication message-digest
 ip ospf message-digest-key 2 md5 XYZ12345
!
router ospf
 ospf router-id 192.168.0.1
 redistribute connected
 passive interface ppp0
 network 192.168.0.0/24 area 0.0.0.0
 network 10.0.0.0/16 area 0.0.0.0
 network 192.168.1.0/24 area 0.0.0.1
 area 0.0.0.0 authentication message-digest
 area 0.0.0.0 range 10.0.0.0/16
 area 0.0.0.0 range 192.168.0.0/24
 area 0.0.0.1 authentication message-digest
 area 0.0.0.1 range 10.2.0.0/16
!

```

Then:

```
hostname HOSTNAME
password PASSWORD
log file
!
!
interface eth0
 ip ospf hello-interval 60
 ip ospf dead-interval 240
!
interface eth1
 ip ospf hello-interval 60
 ip ospf dead-interval 240
!
!
router ospf
 ospf router-id 192.168.1.1
 network 192.168.0.0/16 area 1

!
line vty
```

A router information example with PCE advertisement:

```
!
router ospf
 ospf router-id 192.168.1.1
 network 192.168.0.0/16 area 1
 router-info area 0.0.0.1
 pce address 192.168.1.1
 pce flag 0x80
 pce domain as 65400
 pce neighbor as 65500
 pce neighbor as 65200
 pce scope 0x80
!
```

## 1.4.7 OSPFv3

*ospf6d* is a daemon support OSPF version 3 for IPv6 network. OSPF for IPv6 is described in [RFC 2740](#).

### OSPF6 router

**router ospf6**

**ospf6 router-id A.B.C.D**

Set router's Router-ID.

**interface IFNAME area (0-4294967295)**

**interface IFNAME area A.B.C.D**

Bind interface to specified area, and start sending OSPF packets. *area* can be specified as 0.

**timers throttle spf DELAY INITIAL-HOLDTIME MAX-HOLDTIME****no timers throttle spf**

This command sets the initial *delay*, the *initial-holdtime* and the *maximum-holdtime* between when SPF is calculated and the event which triggered the calculation. The times are specified in milliseconds and must be in the range of 0 to 600000 milliseconds.

The *delay* specifies the minimum amount of time to delay SPF calculation (hence it affects how long SPF calculation is delayed after an event which occurs outside of the holdtime of any previous SPF calculation, and also serves as a minimum holdtime).

Consecutive SPF calculations will always be separated by at least ‘hold-time’ milliseconds. The hold-time is adaptive and initially is set to the *initial-holdtime* configured with the above command. Events which occur within the holdtime of the previous SPF calculation will cause the holdtime to be increased by *initial-holdtime*, bounded by the *maximum-holdtime* configured with this command. If the adaptive hold-time elapses without any SPF-triggering event occurring then the current holdtime is reset to the *initial-holdtime*.

```
router ospf6
timers throttle spf 200 400 10000
```

In this example, the *delay* is set to 200ms, the initial holdtime is set to 400ms and the *maximum holdtime* to 10s. Hence there will always be at least 200ms between an event which requires SPF calculation and the actual SPF calculation. Further consecutive SPF calculations will always be separated by between 400ms to 10s, the hold-time increasing by 400ms each time an SPF-triggering event occurs within the hold-time of the previous SPF calculation.

**auto-cost reference-bandwidth COST****no auto-cost reference-bandwidth**

This sets the reference bandwidth for cost calculations, where this bandwidth is considered equivalent to an OSPF cost of 1, specified in Mbits/s. The default is 100Mbit/s (i.e. a link of bandwidth 100Mbit/s or higher will have a cost of 1. Cost of lower bandwidth links will be scaled with reference to this cost).

This configuration setting **MUST** be consistent across all routers within the OSPF domain.

**OSPF6 area**

Area support for OSPFv3 is not yet implemented.

**OSPF6 interface****ipv6 ospf6 cost COST**

Sets interface’s output cost. Default value depends on the interface bandwidth and on the auto-cost reference bandwidth.

**ipv6 ospf6 hello-interval HELLOINTERVAL**

Sets interface’s Hello Interval. Default 10

**ipv6 ospf6 dead-interval DEADINTERVAL**

Sets interface’s Router Dead Interval. Default value is 40.

**ipv6 ospf6 retransmit-interval RETRANSMITINTERVAL**

Sets interface’s Rxmt Interval. Default value is 5.

**ipv6 ospf6 priority PRIORITY**

Sets interface's Router Priority. Default value is 1.

**ipv6 ospf6 transmit-delay TRANSMITDELAY**

Sets interface's Inf-Trans-Delay. Default value is 1.

**ipv6 ospf6 network (broadcast|point-to-point)**

Set explicitly network type for specified interface.

## OSPF6 route-map

Usage of *ospfd6*'s route-map support.

**set metric [+|-](0-4294967295)**

Set a metric for matched route when sending announcement. Use plus (+) sign to add a metric value to an existing metric. Use minus (-) sign to subtract a metric value from an existing metric.

## Redistribute routes to OSPF6

**redistribute static**

**redistribute connected**

**redistribute ripng**

## Showing OSPF6 information

**show ipv6 ospf6**

**show ipv6 ospf6 database**

This command shows LSA database summary. You can specify the type of LSA.

**show ipv6 ospf6 interface**

To see OSPF interface configuration like costs.

**show ipv6 ospf6 neighbor**

Shows state and chosen (Backup) DR of neighbor.

**show ipv6 ospf6 request-list A.B.C.D**

Shows requestlist of neighbor.

**show ipv6 route ospf6**

This command shows internal routing table.

**show ipv6 ospf6 zebra**

Shows state about what is being redistributed between zebra and OSPF6

## OSPF6 Configuration Examples

Example of ospf6d configured on one interface and area:

```
router ospf6
ospf6 router-id 212.17.55.53
area 0.0.0.0 range 2001:770:105:2::/64
interface eth0 area 0.0.0.0
!
```

### 1.4.8 RIP

RIP – Routing Information Protocol is widely deployed interior gateway protocol. RIP was developed in the 1970s at Xerox Labs as part of the XNS routing protocol. RIP is a distance-vector protocol and is based on the Bellman-Ford algorithms. As a distance-vector protocol, RIP router send updates to its neighbors periodically, thus allowing the convergence to a known topology. In each update, the distance to any given network will be broadcast to its neighboring router.

*ripd* supports RIP version 2 as described in RFC2453 and RIP version 1 as described in RFC1058.

#### RIP netmask

The netmask features of *ripd* support both version 1 and version 2 of RIP. Version 1 of RIP originally contained no netmask information. In RIP version 1, network classes were originally used to determine the size of the netmask. Class A networks use 8 bits of mask, Class B networks use 16 bits of masks, while Class C networks use 24 bits of mask. Today, the most widely used method of a network mask is assigned to the packet on the basis of the interface that received the packet. Version 2 of RIP supports a variable length subnet mask (VLSM). By extending the subnet mask, the mask can be divided and reused. Each subnet can be used for different purposes such as large to middle size LANs and WAN links. FRR *ripd* does not support the non-sequential netmasks that are included in RIP Version 2.

In a case of similar information with the same prefix and metric, the old information will be suppressed. Ripd does not currently support equal cost multipath routing.

#### RIP Configuration

##### **router rip**

The *router rip* command is necessary to enable RIP. To disable RIP, use the *no router rip* command. RIP must be enabled before carrying out any of the RIP commands.

##### **no router rip**

Disable RIP.

##### **network NETWORK**

##### **no network NETWORK**

Set the RIP enable interface by NETWORK. The interfaces which have addresses matching with NETWORK are enabled.

This group of commands either enables or disables RIP interfaces between certain numbers of a specified network address. For example, if the network for 10.0.0.0/24 is RIP enabled, this would result in all the addresses from 10.0.0.0 to 10.0.0.255 being enabled for RIP. The *no network* command will disable RIP for the specified network.

##### **network IFNAME**

**no network IFNAME**

Set a RIP enabled interface by IFNAME. Both the sending and receiving of RIP packets will be enabled on the port specified in the *network ifname* command. The *no network ifname* command will disable RIP on the specified interface.

**neighbor A.B.C.D**

**no neighbor A.B.C.D**

Specify RIP neighbor. When a neighbor doesn't understand multicast, this command is used to specify neighbors. In some cases, not all routers will be able to understand multicasting, where packets are sent to a network or a group of addresses. In a situation where a neighbor cannot process multicast packets, it is necessary to establish a direct link between routers. The neighbor command allows the network administrator to specify a router as a RIP neighbor. The *no neighbor a.b.c.d* command will disable the RIP neighbor.

Below is very simple RIP configuration. Interface *eth0* and interface which address match to *10.0.0.0/8* are RIP enabled.

```
!  
router rip  
network 10.0.0.0/8  
network eth0  
!
```

**passive-interface (IFNAME|default)**

**no passive-interface IFNAME**

This command sets the specified interface to passive mode. On passive mode interface, all receiving packets are processed as normal and ripd does not send either multicast or unicast RIP packets except to RIP neighbors specified with *neighbor* command. The interface may be specified as *default* to make ripd default to passive on all interfaces.

The default is to be passive on all interfaces.

**ip split-horizon**

**no ip split-horizon**

Control split-horizon on the interface. Default is *ip split-horizon*. If you don't perform split-horizon on the interface, please specify *no ip split-horizon*.

**RIP Version Control**

RIP can be configured to send either Version 1 or Version 2 packets. The default is to send RIPv2 while accepting both RIPv1 and RIPv2 (and replying with packets of the appropriate version for REQUESTS / triggered updates). The version to receive and send can be specified globally, and further overridden on a per-interface basis if needs be for send and receive separately (see below).

It is important to note that RIPv1 cannot be authenticated. Further, if RIPv1 is enabled then RIP will reply to REQUEST packets, sending the state of its RIP routing table to any remote routers that ask on demand. For a more detailed discussion on the security implications of RIPv1 see *RIP Authentication*.

**version VERSION**

Set RIP version to accept for reads and send. VERSION can be either 1 or 2.

Disabling RIPv1 by specifying version 2 is STRONGLY encouraged, *RIP Authentication*. This may become the default in a future release.

Default: Send Version 2, and accept either version.



**no version**

Reset the global version setting back to the default.

**ip rip send version VERSION**

VERSION can be 1, 2, or 1 2.

This interface command overrides the global rip version setting, and selects which version of RIP to send packets with, for this interface specifically. Choice of RIP Version 1, RIP Version 2, or both versions. In the latter case, where 1 2 is specified, packets will be both broadcast and multicast.

Default: Send packets according to the global version (version 2)

**ip rip receive version VERSION**

VERSION can be 1, 2, or 1 2.

This interface command overrides the global rip version setting, and selects which versions of RIP packets will be accepted on this interface. Choice of RIP Version 1, RIP Version 2, or both.

Default: Accept packets according to the global setting (both 1 and 2).

**How to Announce RIP route****redistribute kernel****redistribute kernel metric (0-16)****redistribute kernel route-map ROUTE-MAP****no redistribute kernel**

*redistribute kernel* redistributes routing information from kernel route entries into the RIP tables. *no redistribute kernel* disables the routes.

**redistribute static****redistribute static metric (0-16)****redistribute static route-map ROUTE-MAP****no redistribute static**

*redistribute static* redistributes routing information from static route entries into the RIP tables. *no redistribute static* disables the routes.

**redistribute connected****redistribute connected metric (0-16)****redistribute connected route-map ROUTE-MAP****no redistribute connected**

Redistribute connected routes into the RIP tables. *no redistribute connected* disables the connected routes in the RIP tables. This command redistribute connected of the interface which RIP disabled. The connected route on RIP enabled interface is announced by default.

**redistribute ospf****redistribute ospf metric (0-16)****redistribute ospf route-map ROUTE-MAP**

**no redistribute ospf**

*redistribute ospf* redistributes routing information from ospf route entries into the RIP tables. *no redistribute ospf* disables the routes.

**redistribute bgp**

**redistribute bgp metric (0-16)**

**redistribute bgp route-map ROUTE-MAP**

**no redistribute bgp**

*redistribute bgp* redistributes routing information from bgp route entries into the RIP tables. *no redistribute bgp* disables the routes.

If you want to specify RIP only static routes:

**default-information originate**

**route A.B.C.D/M**

**no route A.B.C.D/M**

This command is specific to FRR. The *route* command makes a static route only inside RIP. This command should be used only by advanced users who are particularly knowledgeable about the RIP protocol. In most cases, we recommend creating a static route in FRR and redistributing it in RIP using *redistribute static*.

## Filtering RIP Routes

RIP routes can be filtered by a distribute-list.

**distribute-list ACCESS\_LIST DIRECT IFNAME**

You can apply access lists to the interface with a *distribute-list* command. ACCESS\_LIST is the access list name. DIRECT is in or out. If DIRECT is in the access list is applied to input packets.

The *distribute-list* command can be used to filter the RIP path. *distribute-list* can apply access-lists to a chosen interface. First, one should specify the access-list. Next, the name of the access-list is used in the distribute-list command. For example, in the following configuration eth0 will permit only the paths that match the route 10.0.0.0/8

```
!  
router rip  
  distribute-list private in eth0  
!  
access-list private permit 10 10.0.0.0/8  
access-list private deny any  
!
```

*distribute-list* can be applied to both incoming and outgoing data.

**distribute-list prefix PREFIX\_LIST (in|out) IFNAME**

You can apply prefix lists to the interface with a *distribute-list* command. PREFIX\_LIST is the prefix list name. Next is the direction of in or out. If DIRECT is in the access list is applied to input packets.

## RIP Metric Manipulation

RIP metric is a value for distance for the network. Usually *ripd* increment the metric when the network information is received. Redistributed routes' metric is set to 1.

**default-metric (1-16)**

**no default-metric (1-16)**

This command modifies the default metric value for redistributed routes. The default value is 1. This command does not affect connected route even if it is redistributed by *redistribute connected*. To modify connected route's metric value, please use *redistribute connected metric* or *route-map offset-list* also affects connected routes.

**offset-list ACCESS-LIST (in|out)**

**offset-list ACCESS-LIST (in|out) IFNAME**

## RIP distance

Distance value is used in zebra daemon. Default RIP distance is 120.

**distance (1-255)**

**no distance (1-255)**

Set default RIP distance to specified value.

**distance (1-255) A.B.C.D/M**

**no distance (1-255) A.B.C.D/M**

Set default RIP distance to specified value when the route's source IP address matches the specified prefix.

**distance (1-255) A.B.C.D/M ACCESS-LIST**

**no distance (1-255) A.B.C.D/M ACCESS-LIST**

Set default RIP distance to specified value when the route's source IP address matches the specified prefix and the specified access-list.

## RIP route-map

Usage of *ripd*'s route-map support.

Optional argument route-map MAP\_NAME can be added to each *redistribute* statement.

```
redistribute static [route-map MAP_NAME]
redistribute connected [route-map MAP_NAME]
.....
```

Cisco applies route-map *\_before\_* routes will exported to rip route table. In current FRR's test implementation, *ripd* applies route-map after routes are listed in the route table and before routes will be announced to an interface (something like output filter). I think it is not so clear, but it is draft and it may be changed at future.

Route-map statement (*Route Maps*) is needed to use route-map functionality.

**match interface WORD**

This command match to incoming interface. Notation of this match is different from Cisco. Cisco uses a list of interfaces - NAME1 NAME2 ... NAMEN. Ripd allows only one name (maybe will change in the future). Next - Cisco means interface which includes next-hop of routes (it is somewhat similar to “ip next-hop” statement). Ripd means interface where this route will be sent. This difference is because “next-hop” of same routes which sends to different interfaces must be different. Maybe it'd be better to made new matches - say “match interface-out NAME” or something like that.

**match ip address WORD**

**match ip address prefix-list WORD**

Match if route destination is permitted by access-list.

**match ip next-hop WORD**

**match ip next-hop prefix-list WORD**

Match if route next-hop (meaning next-hop listed in the rip route-table as displayed by “show ip rip”) is permitted by access-list.

**match metric (0-4294967295)**

This command match to the metric value of RIP updates. For other protocol compatibility metric range is shown as (0-4294967295). But for RIP protocol only the value range (0-16) make sense.

**set ip next-hop A.B.C.D**

This command set next hop value in RIPv2 protocol. This command does not affect RIPv1 because there is no next hop field in the packet.

**set metric (0-4294967295)**

Set a metric for matched route when sending announcement. The metric value range is very large for compatibility with other protocols. For RIP, valid metric values are from 1 to 16.

## RIP Authentication

RIPv2 allows packets to be authenticated via either an insecure plain text password, included with the packet, or via a more secure MD5 based HMAC (keyed-Hashing for Message Authentication), RIPv1 can not be authenticated at all, thus when authentication is configured *ripd* will discard routing updates received via RIPv1 packets.

However, unless RIPv1 reception is disabled entirely, *RIP Version Control*, RIPv1 REQUEST packets which are received, which query the router for routing information, will still be honoured by *ripd*, and *ripd* WILL reply to such packets. This allows *ripd* to honour such REQUESTs (which sometimes is used by old equipment and very simple devices to bootstrap their default route), while still providing security for route updates which are received.

In short: Enabling authentication prevents routes being updated by unauthenticated remote routers, but still can allow routes (I.e. the entire RIP routing table) to be queried remotely, potentially by anyone on the internet, via RIPv1.

To prevent such unauthenticated querying of routes disable RIPv1, *RIP Version Control*.

**ip rip authentication mode md5**

**no ip rip authentication mode md5**

Set the interface with RIPv2 MD5 authentication.

**ip rip authentication mode text**

**no ip rip authentication mode text**

Set the interface with RIPv2 simple password authentication.

**ip rip authentication string STRING**

**no ip rip authentication string STRING**

RIP version 2 has simple text authentication. This command sets authentication string. The string must be shorter than 16 characters.

**ip rip authentication key-chain KEY-CHAIN**

**no ip rip authentication key-chain KEY-CHAIN**

Specify Keyed MD5 chain.

```
!
key chain test
  key 1
    key-string test
!
interface eth1
  ip rip authentication mode md5
  ip rip authentication key-chain test
!
```

## RIP Timers

**timers basic UPDATE TIMEOUT GARBAGE**

RIP protocol has several timers. User can configure those timers' values by *timers basic* command.

The default settings for the timers are as follows:

- The update timer is 30 seconds. Every update timer seconds, the RIP process is awakened to send an unsolicited Response message containing the complete routing table to all neighboring RIP routers.
- The timeout timer is 180 seconds. Upon expiration of the timeout, the route is no longer valid; however, it is retained in the routing table for a short time so that neighbors can be notified that the route has been dropped.
- The garbage collect timer is 120 seconds. Upon expiration of the garbage-collection timer, the route is finally removed from the routing table.

The *timers basic* command allows the the default values of the timers listed above to be changed.

**no timers basic**

The *no timers basic* command will reset the timers to the default settings listed above.

## Show RIP Information

To display RIP routes.

**show ip rip**

Show RIP routes.

The command displays all RIP routes. For routes that are received through RIP, this command will display the time the packet was sent and the tag information. This command will also display this information for routes redistributed into RIP.

### show ip rip status

The command displays current RIP status. It includes RIP timer, filtering, version, RIP enabled interface and RIP peer information.

```
ripd> **show ip rip status**
Routing Protocol is "rip"
  Sending updates every 30 seconds with +/-50%, next due in 35 seconds
  Timeout after 180 seconds, garbage collect after 120 seconds
  Outgoing update filter list for all interface is not set
  Incoming update filter list for all interface is not set
  Default redistribution metric is 1
  Redistributing: kernel connected
  Default version control: send version 2, receive version 2
    Interface  Send  Recv
Routing for Networks:
  eth0
  eth1
  1.1.1.1
  203.181.89.241
Routing Information Sources:
  Gateway      BadPackets BadRoutes  Distance Last Update
```

## RIP Debug Commands

Debug for RIP protocol.

### debug rip events

Shows RIP events. Sending and receiving packets, timers, and changes in interfaces are events shown with *ripd*.

### debug rip packet

Shows display detailed information about the RIP packets. The origin and port number of the packet as well as a packet dump is shown.

### debug rip zebra

This command will show the communication between *ripd* and *zebra*. The main information will include addition and deletion of paths to the kernel and the sending and receiving of interface information.

### show debugging rip

Shows all information currently set for *ripd* debug.

## 1.4.9 RIPng

*ripngd* supports the RIPng protocol as described in [RFC 2080](#). It's an IPv6 reincarnation of the RIP protocol.

## Invoking ripngd

There are no *ripngd* specific invocation options. Common options can be specified (common-invocation-options).

## ripngd Configuration

Currently ripngd supports the following commands:

### **router ripng**

Enable RIPng.

### **flush\_timer TIME**

Set flush timer.

### **network NETWORK**

Set RIPng enabled interface by NETWORK.

### **network IFNAME**

Set RIPng enabled interface by IFNAME.

### **route NETWORK**

Set RIPng static routing announcement of NETWORK.

### **router zebra**

This command is the default and does not appear in the configuration. With this statement, RIPng routes go to the *zebra* daemon.

## ripngd Terminal Mode Commands

**show ip ripng**

**show debugging ripng**

**debug ripng events**

**debug ripng packet**

**debug ripng zebra**

## ripngd Filtering Commands

### **distribute-list ACCESS\_LIST (in|out) IFNAME**

You can apply an access-list to the interface using the *distribute-list* command. ACCESS\_LIST is an access-list name. *direct* is in or out. If *direct* is in, the access-list is applied only to incoming packets.:

```
distribute-list local-only out sit1
```

## 1.4.10 STATIC

STATIC is a daemon that handles the installation and deletion of static routes.

### Static Route Commands

Static routing is a very fundamental feature of routing technology. It defines a static prefix and gateway.

```
ip route NETWORK GATEWAY table TABLENO nexthop-vrf VRFNAME DISTANCE vrf VRFNAME
```

```
ipv6 route NETWORK from SRCPREFIX GATEWAY table TABLENO nexthop-vrf VRFNAME DISTANCE vrf VRFNAME
```

NETWORK is destination prefix with a valid v4 or v6 network based upon initial form of the command. GATEWAY is gateway for the prefix it currently must match the v4 or v6 route type specified at the start of the command. GATEWAY can also be treated as an interface name. If the interface name is `null0` then zebra installs a blackhole route. TABLENO is an optional parameter for namespaces that allows you to create the route in a specified table associated with the vrf namespace. table will be rejected if you are not using namespace based vrfs. `nexthop-vrf` allows you to create a leaked route with a nexthop in the specified VRFNAME vrf VRFNAME allows you to create the route in a specified vrf. `nexthop-vrf` cannot be currently used with namespace based vrfs currently as well. The v6 variant allows the installation of a static source-specific route with the SRCPREFIX sub command. These routes are currently supported on Linux operating systems only, and perform AND matching on packet's destination and source addresses in the kernel's forwarding path. Note that destination longest-prefix match is "more important" than source LPM, e.g. `2001:db8:1::/64 from 2001:db8::/48` will win over `2001:db8::/48 from 2001:db8:1::/64` if both match.

### Multiple nexthop static route

To create multiple nexthops to the same NETWORK, just reenter the same network statement with different nexthop information.

```
ip route 10.0.0.1/32 10.0.0.2
ip route 10.0.0.1/32 10.0.0.3
ip route 10.0.0.1/32 eth0
```

If there is no route to 10.0.0.2 and 10.0.0.3, and interface eth0 is reachable, then the last route is installed into the kernel.

If zebra has been compiled with multipath support, and both 10.0.0.2 and 10.0.0.3 are reachable, zebra will install a multipath route via both nexthops, if the platform supports this.

```
router> show ip route
S> 10.0.0.1/32 [1/0] via 10.0.0.2 inactive
   via 10.0.0.3 inactive
*      is directly connected, eth0
```

```
ip route 10.0.0.0/8 10.0.0.2
ip route 10.0.0.0/8 10.0.0.3
ip route 10.0.0.0/8 null0 255
```

This will install a multihop route via the specified next-hops if they are reachable, as well as a high-distance blackhole route, which can be useful to prevent traffic destined for a prefix to match less-specific routes (e.g. default) should the specified gateways not be reachable. E.g.:



```

router> show ip route 10.0.0.0/8
Routing entry for 10.0.0.0/8
  Known via "static", distance 1, metric 0
    10.0.0.2 inactive
    10.0.0.3 inactive

Routing entry for 10.0.0.0/8
  Known via "static", distance 255, metric 0
  directly connected, Null0

```

Also, if the user wants to configure a static route for a specific VRF, then a specific VRF configuration mode is available. After entering into that mode with `vrf VRF` the user can enter the same route command as before, but this time, the route command will apply to the VRF.

```

# case with VRF
configure
vrf r1-cust1
  ip route 10.0.0.0/24 10.0.0.2
exit-vrf

```

### 1.4.11 PIM

PIM – Protocol Independent Multicast

`pimd` supports pim-sm as well as igmp v2 and v3. pim is vrf aware and can work within the context of vrf's in order to do S,G mrouting.

#### **ip pim rp A.B.C.D A.B.C.D/M**

In order to use pim, it is necessary to configure a RP for join messages to be sent to. Currently the only methodology to do this is via static rp commands. All routers in the pim network must agree on these values. The first ip address is the RP's address and the second value is the matching prefix of group ranges covered. This command is vrf aware, to configure for a vrf, enter the vrf submode.

#### **ip pim register-accept-list PLIST**

When pim receives a register packet the source of the packet will be compared to the prefix-list specified, PLIST, and if a permit is received normal processing continues. If a deny is returned for the source address of the register packet a register stop message is sent to the source.

#### **ip pim spt-switchover infinity-and-beyond**

On the last hop router if it is desired to not switch over to the SPT tree. Configure this command. This command is vrf aware, to configure for a vrf, enter the vrf submode.

#### **ip pim ecmp**

If pim has the a choice of ECMP nexthops for a particular RPF, pim will cause S,G flows to be spread out amongst the nexthops. If this command is not specified then the first nexthop found will be used. This command is vrf aware, to configure for a vrf, enter the vrf submode.

#### **ip pim ecmp rebalance**

If pim is using ECMP and an interface goes down, cause pim to rebalance all S,G flows across the remaining nexthops. If this command is not configured pim only modifies those S,G flows that were using the interface that went down. This command is vrf aware, to configure for a vrf, enter the vrf submode.

#### **ip pim join-prune-interval (60-600)**

Modify the join/prune interval that pim uses to the new value. Time is specified in seconds. This command is vrf aware, to configure for a vrf, enter the vrf submode.

**ip pim keep-alive-timer (31-60000)**

Modify the time out value for a S,G flow from 31-60000 seconds. 31 seconds is chosen for a lower bound because some hardware platforms cannot see data flowing in better than 30 second chunks. This command is vrf aware, to configure for a vrf, enter the vrf submode.

**ip pim packets (1-100)**

When processing packets from a neighbor process the number of packets incoming at one time before moving on to the next task. The default value is 3 packets. This command is only useful at scale when you can possibly have a large number of pim control packets flowing. This command is vrf aware, to configure for a vrf, enter the vrf submode.

**ip pim register-suppress-time (5-60000)**

Modify the time that pim will register suppress a FHR will send register notifications to the kernel. This command is vrf aware, to configure for a vrf, enter the vrf submode.

**ip pim send-v6-secondary**

When sending pim hello packets tell pim to send any v6 secondary addresses on the interface. This information is used to allow pim to use v6 nexthops in it's decision for RPF lookup. This command is vrf aware, to configure for a vrf, enter the vrf submode.

**ip pim ssm prefix-list WORD**

Specify a range of group addresses via a prefix-list that forces pim to never do SM over. This command is vrf aware, to configure for a vrf, enter the vrf submode.

**ip multicast rpf-lookup-mode WORD**

Modify how PIM does RPF lookups in the zebra routing table. You can use these choices:

**longer-prefix**

Lookup the RPF in both tables using the longer prefix as a match

**lower-distance**

Lookup the RPF in both tables using the lower distance as a match

**mrrib-only**

Lookup in the Multicast RIB only

**mrrib-then-urib**

Lookup in the Multicast RIB then the Unicast Rib, returning first found. This is the default value for lookup if this command is not entered

**urib-only**

Lookup in the Unicast Rib only.

**[no] ip msdp mesh-group [WORD]**

Create or Delete a multicast source discovery protocol mesh-group using [WORD] as the group name.

**[no] ip msdp mesh-group WORD member A.B.C.D**

Attach or Delete A.B.C.D to the MSDP mesh group WORD specified.

**[no] ip msdp mesh-group WORD source A.B.C.D**

For the address specified A.B.C.D use that as the source address for mesh group packets being sent.

**ip igmp generate-query-once [version (2-3)]**

Generate IGMP query (v2/v3) on user requirement. This will not depend on the existing IGMP general query timer.If no version is provided in the cli, it will be considered as default v2 query.This is a hidden command.

**[no] ip igmp watermark-warn (10-60000)**

Configure watermark warning generation for an igmp group limit. Generates warning once the configured group limit is reached while adding new groups. 'no' form of the command disables the warning generation. This command is vrf aware. To configure per vrf, enter vrf submenu.

**PIM Interface Configuration**

PIM interface commands allow you to configure an interface as either a Receiver or a interface that you would like to form pim neighbors on. If the interface is in a vrf, enter the interface command with the vrf keyword at the end.

**ip pim active-active**

Turn on pim active-active configuration for a Vxlan interface. This command will not do anything if you do not have the underlying ability of a mlag implementation.

**ip pim bfd**

Turns on BFD support for PIM for this interface.

**ip pim bsm**

Tell pim that we would like to use this interface to process bootstrap messages. This is enabled by default. 'no' form of this command is used to restrict bsm messages on this interface.

**ip pim unicast-bsm**

Tell pim that we would like to allow interface to process unicast bootstrap messages. This is enabled by default. 'no' form of this command is used to restrict processing of unicast bsm messages on this interface.

**ip pim drpriority (1-4294967295)**

Set the DR Priority for the interface. This command is useful to allow the user to influence what node becomes the DR for a lan segment.

**ip pim hello (1-180) (1-180)**

Set the pim hello and hold interval for a interface.

**ip pim**

Tell pim that we would like to use this interface to form pim neighbors over. Please note that this command does not enable the reception of IGMP reports on the interface. Refer to the next *ip igmp* command for IGMP management.

**[no] ip pim use-source A.B.C.D**

If you have multiple addresses configured on a particular interface and would like pim to use a specific source address associated with that interface.

**ip igmp**

Tell pim to receive IGMP reports and Query on this interface. The default version is v3. This command is useful on a LHR.

**ip igmp join A.B.C.D [A.B.C.D]**

Join multicast group or source-group on an interface.

**ip igmp query-interval (1-1800)**

Set the IGMP query interval that PIM will use.

**ip igmp query-max-response-time (10-250)**

Set the IGMP query response timeout value. If an report is not returned in the specified time we will assume the S,G or \*,G has timed out.

**ip igmp version (2-3)**

Set the IGMP version used on this interface. The default value is 3.

**ip multicast boundary oil WORD**

Set a pim multicast boundary, based upon the WORD prefix-list. If a pim join or IGMP report is received on this interface and the Group is denied by the prefix-list, PIM will ignore the join or report.

**ip igmp last-member-query-count (1-7)**

Set the IGMP last member query count. The default value is 2. 'no' form of this command is used to to configure back to the default value.

**ip igmp last-member-query-interval (1-255)**

Set the IGMP last member query interval in deciseconds. The default value is 10 deciseconds. 'no' form of this command is used to to configure back to the default value.

**ip mroute INTERFACE A.B.C.D [A.B.C.D]**

Set a static multicast route for a traffic coming on the current interface to be forwarded on the given interface if the traffic matches the group address and optionally the source address.

**PIM Multicast RIB insertion:**

In order to influence Multicast RPF lookup, it is possible to insert into zebra routes for the Multicast RIB. These routes are only used for RPF lookup and will not be used by zebra for insertion into the kernel *or* for normal rib processing. As such it is possible to create weird states with these commands. Use with caution. Most of the time this will not be necessary.

**ip mroute A.B.C.D/M A.B.C.D (1-255)**

Insert into the Multicast Rib Route A.B.C.D/M with specified nexthop. The distance can be specified as well if desired.

**ip mroute A.B.C.D/M INTERFACE (1-255)**

Insert into the Multicast Rib Route A.B.C.D/M using the specified INTERFACE. The distance can be specified as well if desired.

**Show PIM Information**

All PIM show commands are vrf aware and typically allow you to insert a specified vrf command if information is desired about a specific vrf. If no vrf is specified then the default vrf is assumed. Finally the special keyword 'all' allows you to look at all vrfs for the command. Naming a vrf 'all' will cause great confusion.

**show ip igmp interface**

Display IGMP interface information.

**show ip igmp join**

Display IGMP static join information.

**show ip igmp groups**

Display IGMP groups information.

**show ip igmp groups retransmissions**

Display IGMP group retransmission information.

**show ip igmp sources**

Display IGMP sources information.

**show ip igmp sources retransmissions**

Display IGMP source retransmission information.

**show ip igmp statistics**

Display IGMP statistics information.

**show ip multicast**

Display various information about the interfaces used in this pim instance.

**show ip mroute [vrf NAME] [A.B.C.D [A.B.C.D]] [fill] [json]**

Display information about installed into the kernel S,G mroutes. If one address is specified we assume it is the Group we are interested in displaying data on. If the second address is specified then it is Source Group. The keyword *fill* says to fill in all assumed data for test/data gathering purposes.

**show ip mroute [vrf NAME] count [json]**

Display information about installed into the kernel S,G mroutes and in addition display data about packet flow for the mroutes for a specific vrf.

**show ip mroute vrf all count [json]**

Display information about installed into the kernel S,G mroutes and in addition display data about packet flow for the mroutes for all vrfs.

**show ip mroute [vrf NAME] summary [json]**

Display total number of S,G mroutes and number of S,G mroutes installed into the kernel for a specific vrf.

**show ip mroute vrf all summary [json]**

Display total number of S,G mroutes and number of S,G mroutes installed into the kernel for all vrfs.

**show ip pim assert**

Display information about asserts in the PIM system for S,G mroutes.

**show ip pim assert-internal**

Display internal assert state for S,G mroutes

**show ip pim assert-metric**

Display metric information about assert state for S,G mroutes

**show ip pim assert-winner-metric**

Display winner metric for assert state for S,G mroutes

**show ip pim group-type**

Display SSM group ranges.

**show ip pim interface**

Display information about interfaces PIM is using.

**show ip pim mlag [vrf NAME|all] interface [detail|WORD] [json]**

Display mlag interface information.

**show ip pim join**

Display information about PIM joins received. If one address is specified then we assume it is the Group we are interested in displaying data on. If the second address is specified then it is Source Group.

**show ip pim local-membership**

Display information about PIM interface local-membership.

**show ip pim mlag summary [json]**

Display mlag information state that PIM is keeping track of.

**show ip pim neighbor**

Display information about PIM neighbors.

**show ip pim nexthop**

Display information about pim nexthops that are being used.

**show ip pim nexthop-lookup**

Display information about a S,G pair and how the RPF would be chosen. This is especially useful if there are ECMP's available from the RPF lookup.

**show ip pim rp-info**

Display information about RP's that are configured on this router.

**show ip pim rpf**

Display information about currently being used S,G's and their RPF lookup information. Additionally display some statistics about what has been happening on the router.

**show ip pim secondary**

Display information about an interface and all the secondary addresses associated with it.

**show ip pim state**

Display information about known S,G's and incoming interface as well as the OIL and how they were chosen.

**show ip pim upstream**

Display upstream information about a S,G mroute. Allow the user to specify sub Source and Groups that we are only interested in.

**show ip pim upstream-join-desired**

Display upstream information for S,G's and if we desire to join the multicast tree

**show ip pim upstream-rpf**

Display upstream information for S,G's and the RPF data associated with them.

**show ip pim mlag upstream**

Display upstream entries that are synced across MLAG switches. Allow the user to specify sub Source and Groups address filters.

**show ip pim mlag summary**

Display PIM MLAG (multi-chassis link aggregation) session status and control message statistics.

**show ip pim bsr**

Display current bsr, its uptime and last received bsm age.

**show ip pim bsrp-info**

Display group-to-rp mappings received from E-BSR.

**show ip pim bsm-database**

Display all fragments of stored bootstrap message in user readable format.

**show ip rpf**

Display the multicast RIB created in zebra.

**mtrace A.B.C.D [A.B.C.D]**

Display multicast traceroute towards source, optionally for particular group.

**show ip multicast count [vrf NAME] [json]**

Display multicast data packets count per interface for a vrf.

**show ip multicast count vrf all [json]**

Display multicast data packets count per interface for all vrf.

## PIM Debug Commands

The debugging subsystem for PIM behaves in accordance with how FRR handles debugging. You can specify debugging at the enable CLI mode as well as the configure CLI mode. If you specify debug commands in the configuration cli mode, the debug commands can be persistent across restarts of the FRR pimd if the config was written out.

### **debug igmp**

This turns on debugging for IGMP protocol activity.

### **debug mtrace**

This turns on debugging for mtrace protocol activity.

### **debug mroute**

This turns on debugging for PIM interaction with kernel MFC cache.

### **debug pim events**

This turns on debugging for PIM system events. Especially timers.

### **debug pim nht**

This turns on debugging for PIM nexthop tracking. It will display information about RPF lookups and information about when a nexthop changes.

### **debug pim packet-dump**

This turns on an extraordinary amount of data. Each pim packet sent and received is dumped for debugging purposes. This should be considered a developer only command.

### **debug pim packets**

This turns on information about packet generation for sending and about packet handling from a received packet.

### **debug pim trace**

This traces pim code and how it is running.

### **debug pim bsm**

This turns on debugging for BSR message processing.

### **debug pim zebra**

This gathers data about events from zebra that come up through the ZAPI.

## PIM Clear Commands

Clear commands reset various variables.

### **clear ip interfaces**

Reset interfaces.

### **clear ip igmp interfaces**

Reset IGMP interfaces.

### **clear ip mroute**

Reset multicast routes.

### **clear ip mroute [vrf NAME] count**

When this command is issued, reset the counts of data shown for packet count, byte count and wrong interface to 0 and start count up from this spot.

### **clear ip pim interfaces**

Reset PIM interfaces.

### clear ip pim oil

Rescan PIM OIL (output interface list).

## PIM EVPN configuration

To use PIM in the underlay for overlay BUM forwarding associate a multicast group with the L2 VNI. The actual configuration is based on your distribution. Here is an ifupdown2 example:

```
auto vx-10100
iface vx-10100
    vxlan-id 10100
    bridge-access 100
    vxlan-local-tunnelip 27.0.0.11
    vxlan-mcastgrp 239.1.1.100
```

---

**Note:** PIM will see the vxlan-mcastgrp configuration and auto configure state to properly forward BUM traffic.

---

PIM also needs to be configured in the underlay to allow the BUM MDT to be setup. This is existing PIM configuration:

- Enable pim on the underlay L3 interface via the “ip pim” command.
- Configure RPs for the BUM multicast group range.
- Ensure the PIM is enabled on the lo of the VTEPs and the RP.

## 1.5 NAT

### 1.5.1 NAT

Network Address Translation is a method of changing packet IP addresses. SoodarOS uses PNAT variation, which changes Port and Address.

#### NAT Static Mapping

Define a static mapping for address translation.

#### Address only NAT

In this mode, only the address is translated to the given address. Depending on flow direction( whether it's in2out or out2in), the source or destination of the packet is changed.

When a packet containing a *source* same as *local address* is passing through an *input* interface, its *source* is replaced with *global address*. When a packet containing a *destination* same as *global address* is passing through an *output* interface, its *destination* is replaced with *local address*.

#### ip nat inside source static A.B.C.D A.B.C.D

Add a new static map entry to the NAT static table. The first IP is a local address, and the second is a global address.

Example :



```
soodar(config)# ip nat inside source static 192.168.1.10 85.20.1.1
soodar(config)# interface ge0
soodar(config-if)# ip nat inside
soodar(config)# interface ge1
soodar(config-if)# ip nat outside
```

Define a static map entry that translates every ingress traffic from *ge0* sourced from *192.168.1.10* to *85.20.1.1* ( Also known as *Source NAT*). Every packet coming from *ge1*, which is destined to *85.20.1.1*, is also translated to *192.168.1.10*

```
soodar(config)# ip nat inside source static 85.20.1.1 192.168.1.10
soodar(config)# interface ge0
soodar(config-if)# ip nat outside
soodar(config)# interface ge1
soodar(config-if)# ip nat inside
```

Define a static map entry that translates every ingress traffic from *ge0* destined to *192.168.1.10* to *85.20.1.1* ( Also known as *Destination NAT*). Every packet coming from *ge1*, which is sourced from *85.20.1.1*, is also translated to *192.168.1.10*

## Protocol NAT

Sometimes we need to be more specific about our NAT and translate a specified protocol on a defined port. So when defining an entry, we introduce the protocol and desired ports. All other aspects of this entry( including behavior) are simple *Address only NAT*.

**ip nat inside source static <tcp|udp> A.B.C.D (1-65535) A.B.C.D (1-65535)**

Add a new static map entry to the NAT static table. The first IP is a local address, and the number following is its port. The second IP is a global address, and the number following is its port.

Example :

```
soodar(config)# ip nat inside source static tcp 192.168.1.10 444 85.20.1.1 666
soodar(config)# interface ge0
soodar(config-if)# ip nat inside
soodar(config)# interface ge1
soodar(config-if)# ip nat outside
```

Define a static map entry that translates every ingress traffic from *ge0* sourced from *192.168.1.10:444* to *85.20.1.1:666* ( Also known as *Source NAT*). Every packet coming from *ge1*, which is destined to *85.20.1.1:666*, is also translated to *192.168.1.10:444*

```
soodar(config)# ip nat inside source static tcp 85.20.1.1 666 192.168.1.10 444
soodar(config)# interface ge0
soodar(config-if)# ip nat outside
soodar(config)# interface ge1
soodar(config-if)# ip nat inside
```

Define a static map entry that translates every ingress traffic from *ge0* destined to *192.168.1.10:444* to *85.20.1.1:666* ( Also known as *Destination NAT*). Every packet coming from *ge1*, which is sourced from *85.20.1.1:666*, is also translated to *192.168.1.10:444*

### Dynamic NAT

In dynamic NAT, every packet's source outgoing from an *input* interface and destined to an *output* interface is translated to an IP, provided by IP pool.

For every *source translation*, a new session is created, and its state is kept. So the packets coming from an *output* interface and having a matched session, its destination is changed with respect to the session's information.

### NAT IP pool

A pool of available IP addresses to use as a NAT IP.

```
ip nat pool PNAT44 A.B.C.D [ A.B.C.D ]
```

Add an IP( or an IP range if the second IP is provided) to a nat pool named PNAT44

Example :

```
soodar(config)# ip nat pool p1 1.1.1.1
soodar(config)# ip nat pool p2 2.1.1.1 2.1.1.10
```

The first command is to create *p1* nat pool and add IP *1.1.1.1* to it. the second one adds *2.1.1.1* to *2.1.1.10* to *p2* nat pool.

### Put interface behind NAT

```
ip nat inside
```

Define an interface as a NAT inside interface.

```
ip nat outside
```

Define an interface as a NAT outside interface.

### Logging

Debugging logs can be set in case of need.

```
[no] debug nat44 event
```

log data plane installation processes and results

### Example configuration

```
soodar(config)# int ge0
soodar(config-if)# ip nat outside
soodar(config)# int ge2
soodar(config-if)# ip nat inside
soodar(config)# ip nat pool nat1 200.1.2.1
```

## 1.6 Qos

### 1.6.1 QoS

#### Class Map

A class map is a set of rules to classify traffic.

#### Define Class Map

Class maps operate in two modes:

- Match all modes. Requires all circumstances be fulfilled
- Just matching a criterion is enough to classify the class as defined.

**class-map match-all CNAME**

Create a match all class map and enter in class map config mode

**class-map match-any CNAME**

Create a match any class map and enter in class map config mode

**no class-map CNAM**

Removes a class map

Example :

```
n1(config)# class-map match-all cmap1
n1(config-cmap)#
```

#### Define matching criteria

As said, a class map is a tool to classify traffic. so we need to define criteria. The keyword `match` is used to define a rule for matching. A packet could be matched against its source, destination, etc.

**match any**

Every packet is accepted.

**no match any**

Negate match any command and remove it from criteria

**[no] match access-list ACL**

---

**Note:** Only permit rules in ACL are considered.

---

**[no] match source-address A.B.C.D/M**

**[no] match destination-address A.B.C.D/M**

**[no] match source-address X:X::X:X/M**

**[no] match destination-address X:X::X:X/M**

**[no] match dscp (0-63)**

Match against packet DSCP value

**[no] match protocol (0-63)**

Match against packet protocol number

Example :

```
n1(config-cmap)# match destination-address 200.1.2.2
n1(config-cmap)# match access-list acl1
```

## Policy Map

A policy map is a set of traffic policies attached to an interface. Currently, the only policy available is *traffic policing*. Policy map uses class maps as a base and defines policies based on the class map.

## Define Policy Map

**policy-map NAME**

Create a policy map

**no policy-map NAME**

Delete a policy map

## Define a new policy

**class CNAME**

Enter class map policy config mode

**police BPS [NORMALBURST [MAXBURST]] conform-action ACTION exceed-action ACTION [violate-action ACTION]**

Define a police policy for entered class map. In the above command, BPS is the average bitrate of this traffic class.

NORMALBURST and MAXBURST are token buckets' sizes.

ACTIONs are : *transmit*, *drop* and *set-dscp-transmit*. and the conditions are *conform*, *exceed* and *violate* ( which is optional).

*transmit* and *drop* actions, work as their names suggest. The *set-dscp-transmit* action allows the traffic to be passed. But the DSCP value of the packet is changed.

*conform* condition, is when data burst, is below the NORMALBURST rate. The *exceed* condition is when the data burst is between NORMALBURST and MAXBURST.

*violate* condition, is when data burst, is over MAXBURST rate. When a violate-action is not defined, the algorithm is just a single token bucket algorithm and only *conform* ( below NORMALBURST) and *exceed* ( over NORMALBURST) occurs.

**no class CNAME**

Remove all policies defined for a class map

**no police**

Remove police policy defined for a class map

Example :

```
n1(config)# policy-map pmap1
n1(config-pmap)# class cmap1
n1(config-pmap-c)# police 100K conform-action transmit exceed-action drop
n1(config-pmap)# class cmap2
n1(config-pmap-c)# police 10K conform-action transmit exceed-action set-dscp-
↳transmit 24 violate-action drop
```

## Apply to interface

Currently a policy map can be applied to just ingress traffic.

**service-policy PMAP in**

Example :

```
n1(config-if)# service-policy pmap1 in
```

## Show commands

**show policy-map [NAME]**

Example :

```
n1(config)# do sh policy-map pmap1

Policy Map pmap1
  Class cmap
    Police CIR 102400 (bps) CB 25600 (byte) EB 35840 (byte)
    Conform Action : Transmit
    Exceed Action : Drop
```

Debugging logs can be set in case of need.

**[no] debug qos event**

log data plane installation processes and results

## 1.7 Access Control List

### 1.7.1 IP Access List

Soodar router is shipped with a rich *ip access list* set of tools. It supports *standard ACLs* and *extended ACLs* in a named manner. An access list uses a *first match* approach. That means the first entry that matches is selected as the result, and the whole process of evaluation is terminated.

## Define an ACL

To define an *ipv4* access list, issue the following command:

**ip access-list ACL4**

ACL4 is access list name.

Example :

```
soodar(config)# ip access-list ACL_TEST
soodar(config-nacl)#
```

## Delete an ACL

Use no command to delete an ACL

**no ip access-list ACL4**

## Remark

You can include comments or remark about the IP access list

**remark LINE ..**

Adds a remark for the access list. The remark indicates the purpose of the access list.

## Define an entry

Rules( or entries) can be defined in access-list configuration mode

Since access lists use *first match* approach, entries have priorities. It is by default sequential( the first entry has the highest priority), and behavior can be changed by using *sequence numbers*

To enter the ACL config mode, it is just required to enter ACL's name.

```
soodar(config)# ip access-list ACL_TEST
soodar(config-nacl)# permit any
```

An access list can contain both the standard and extended ACL rules.

**(1-4294967295) <deny|permit> <any|A.B.C.D/M>**

Standard ACL entry rule. It is limited to controlling traffic only based on the source IP address.

**(1-4294967295) <deny|permit> <any|A.B.C.D/M> <any|A.B.C.D/M> [exact-match]**

Create a simple IPv4 entry. Matches against all IP packets. if *exact-match* is entered, the prefixes are also checked and should be the same( 192.168.1.1/24 is not a match in 192.168.1.1/16). The first input is the entry sequence number. The following input is the action done when entry is matched. Then we have *source* and *destination* prefixes. Instead of specifying each address, the user can input any to match every address.

Example :

```
n1(config)# ip access-list TEST_ACL1
n1(config-nacl)# deny any 10.1.16.68/32
n1(config-nacl)# permit any any
```

**Note:** It's the best practice to add a `permit any` rule as the latest entry because by default if a packet doesn't match against non of the entries, it will be dropped.

(1-4294967295) <deny|permit> PROTOSERVICE <any|A.B.C.D/M> <any|A.B.C.D/M> [exact-match]

Create an IP entry based on service or protocol.

Example :

```
n1(config)# ip access-list SSH_DENY deny ssh any any
n1(config)# ip access-list SSH_DENY permit any any

Deny any ``SSH`` connection. This entry creates a rule which denies *TCP*
↪connection to port *22* from the source.

::

ip access-list TEST_ACL1 deny tcp any le 65535 any eq 22
```

(1-4294967295) <deny|permit> tcp <any|A.B.C.D/M> SRC\_PORT <any|A.B.C.D/M> DST\_PORT [tcp-flag-mask (0-255)] [TCP FLAGS] [exact-match]

(1-4294967295) <deny|permit> udp <any|A.B.C.D/M> SRC\_PORT <any|A.B.C.D/M> DST\_PORT [exact-match]

```
n1(config)# ip access-list DENY_DNS
n1(config-nacl)# deny udp any eq domain any

Deny any DNS service
```

(1-4294967295) <deny|permit> icmp <any|A.B.C.D/M> <any|A.B.C.D/M> ICMP\_TYPE\_CODES [exact-match]"

ICMP\_TYPE\_CODES is Well known ICMP message code type to match. They can be defined by their name( like echo-reply) or their *code* and *type* values.

## Negate an entry

Just use `no` form of command

Example in config mode:

```
soodar(config)# ip access-list ACL_TEST
soodar(config-nacl)# no 100
soodar(config-nacl)# no 10 deny tcp 10.0.0.0/8 eq www 64.233.185.113/32
soodar(config-nacl)# no deny udp any 8.8.8.8 eq 53
```

You can negate an entry by using its sequence number, its definition or both of them

## ACL Resequencing

By default, the ACL sequence number starts from 10 and increases with a 10 step factor. To change this behavior use the following command

```
access-list resequence ACL4 (1-2147483647) (1-32765)
```

Resequene all access list entries. The first number is the beginning, and the second is the step.

## Apply ACL

An ACL is applied to the ingress or egress traffic of an interface.

```
ip access-group ACL4 in
```

Apply an IPv4 ACL to the interface's input traffic

Example :

```
n1(config)# interface ge3
n1(config-if)# ip access-group IN_ACL in
```

```
ipv6 access-group ACL6 in
```

```
ip access-group ACL4 out
```

Apply an IPv4 ACL to the interface's output traffic

```
ipv6 access-group ACL6 out
```

```
ip access-group ACL4 in out
```

Apply ACL to both ways of traffic

```
ipv6 access-group ACL6 in out
```

```
no ip access-group ACL4 in
```

Detach an IPv4 ACL from the interface's input traffic

```
no ipv6 access-group ACL6 in
```

```
no ip access-group ACL4 out
```

Detach an IPv4 ACL from the interface's output traffic

```
no ipv6 access-group ACL6 out
```

```
no ip access-group ACL4 in out
```

Detach ACL from both ways of traffic

```
no ipv6 access-group ACL6 in out
```

## Debug

```
show ip access-list [NAME]
```

Example :

```
n1# show ip access-list
IP access list TESTACL1
  10 permit tcp 1.1.1.10/32 eq 200 2.1.1.0/24 ge 5060 tcp-flag-mask 0 tcp-flag-
↵value 0
```



Debugging logs can be set in case of need.

**[no] debug acl event**

log data plane installation processes and results

## 1.8 VRF

### 1.8.1 VRF

#### Define a VRF

**vrf (VRF\_NAME)**

Define a new VRF

Example :

```
n1(config)# vrf vrf-green
```

#### Add an interface to VRF

**ip vrf forwarding NAME**

Add interface to VRF NAME

**no ip vrf forwarding [NAME]**

Add interface to VRF default

---

**Note:** When adding/removing interface to VRF, make sure no valid IP is set on it

---

Example:

```
n1(config)# int ge3
n1(config-if)# ip vrf forwarding vrf-green
n1(config-if)# ip address 200.1.2.20/24
```

#### VRF Configuration examples

##### VRF Trunking

Example :

```
n1(config)# int ge1.100
n1(config-if)# encapsulation dot1q 100
n1(config-if)# ip vrf forwarding vrf-green
n1(config-if)# ip address 200.1.2.20/24
n1(config)# int ge2
n1(config-if)# rewrite tag push 1 dot1q 300
```

## Dynamic routing in VRF

Example:

```
soodar3(config)# router ospf vrf vrf-green
soodar3(config-router)# network 200.2.3.0/24 area 0
soodar3(config-router)# network 3.2.1.0/24 area 0
soodar3(config-if) # end
```

## VRF FIB

Example:

```
soodar1# sh ip ospf vrf vrf-green route
soodar1# sh ip fib vrf vrf-green
soodar1# sh ip fib vrf all
```

## Display VRF info

**show vrf**

Example:

```
n1# sh vrf
vrf vrf-blue id 5 table 300
```

## Logging

Debugging logs can be set in case of need.

**[no] debug vrf event**

logs data plane installation processes and results

# 1.9 MPLS

## 1.9.1 MPLS

### Enable MPLS on interface

**[no] mpls ip**

**[no] mpls ipv6**

Example :

```
soodar(config)# int ge0
soodar(config-if)# mpls ip
soodar(config)# int ge3
soodar(config-if)# mpls ipv6
```

---

**Note:** LDP router-id and discovery transport-address should be set before enabling MPLS.

---

## 1.10 Security

### 1.10.1 Tunnels

SoodarOS support many Layer 2 and Layer 3 tunnels, including: GRE, IP/IP, VXLAN and VPLS

#### Layer 3 Tunnels

Layer 3 Tunnels Includes:

- GRE
- IP/IP

#### Create L3 Tunnel

**interface tunnel [vrf VRF] (0-1023)**

Create a new tunnel with instance number input.

**no interface tunnel**

Delete a tunnel

**tunnel source <A.B.C.D|X:X::X:X>**

**tunnel destination <A.B.C.D|X:X::X:X>**

**[no] tunnel vrf VRF**

Lookup for tunnel destination in VRF's FIB.

**tunnel mode ipip**

Set tunnel mode to IP-IP

**tunnel mode ipip multipoint**

Set tunnel mode to IP-IP multipoint

**tunnel mode gre**

**tunnel mode gre multipoint**

Set tunnel mode to GRE MP.

---

**Note:** In multipoint mode, destination should not be set. Use `nhrp` instead.

---

**tunnel protection ipsec profile IPSECPROFILE**

Protect tunnel with IPsec. see *Profile*

**Warning:** Currently, the protection mode is only supported in P2P tunnels.

---

**Note:** When a tunnel is in protected mode, It is put in shutdown mode until the IPSec SAs are established.

---

---

**Note:** When IPSec SAs protecting a tunnel are gone, the tunnel immediately shuts down. Reestablishing SAs make tunnel available again.

---

### Logging

Debugging logs can be set in case of need.

#### **[no] debug tunnel event**

log data plane installation processes and results

### GRE configuration example

In the first peer we have:

```
soodar1(config)# interface tunnel 10
soodar1(config-if)# tunnel source 200.1.2.1
soodar1(config-if)# tunnel destination 200.1.2.2
soodar1(config-if)# tunnel mode gre
soodar1(config-if)# ip address 192.168.1.1/32
```

In the second peer we have:

```
soodar2(config)# interface tunnel 10
soodar2(config-if)# tunnel source 200.1.2.2
soodar2(config-if)# tunnel destination 200.1.2.1
soodar2(config-if)# tunnel mode gre
soodar2(config-if)# ip address 192.168.1.2/32
```

And then, we add IP routes:

```
soodar1(config)# ip route 2.1.1.0/24 tunnel10
```

```
soodar2(config)# ip route 1.1.1.0/24 tunnel10
```

### GRE-MP configuration example

Currently, only NHRP static mapping is available.

In the first peer we have:

```
soodar1(config)# interface tunnel 10
soodar1(config-if)# tunnel source 200.1.2.1
soodar1(config-if)# tunnel mode gre multipoint
soodar1(config-if)# ip address 192.168.1.1/32
soodar1(config-if)# ip nhrp map 192.168.1.2 200.1.2.2
```

In the second peer we have:

```
soodar2(config)# interface tunnel 10
soodar2(config-if)# tunnel source 200.1.2.2
soodar2(config-if)# tunnel mode gre multipoint
soodar2(config-if)# ip address 192.168.1.2/32
soodar2(config-if)# ip nhrp map 192.168.1.1 200.1.2.1
```

And then, we add IP routes:

```
soodar1(config)# ip route 2.1.1.0/24 192.168.1.2
```

```
soodar2(config)# ip route 1.1.1.0/24 192.168.1.1
```

## VXLAN

Virtual Extensible LAN (VXLAN) is a proposed encapsulation protocol for running an overlay network on existing Layer 3 infrastructure.

### interface nve (0-1023)

Create an NVE interface with instance

Example :

```
soodar(config)# interface nve 40
```

### source-ip <A.B.C.D|X:X::X:X>

Set NVE source IP

### ingress-replication A.B.C.D

Set NVE destination IP

### member vni (1-16777214)

Associate NVE to VNI number.

---

**Note:** For now, each NVE interface can associate to 1 VNI

---

### member vni (1-16777214) associate-vrf

Associate NVE to VNI number and VRF that use this VNI number. Now tunnel lookup its *ingress-replication's* path from the VRF that shares the same VNI with the tunnel.

---

**Note:** Each VRF can associate to 1 VNI

---

Example :

```
soodar(config)# interface nve 10
soodar(config-if)# source-ip 200.1.3.1
soodar(config-if)# ingress-replication 156.25.4.89
soodar(config-if)# member vni 40
soodar(config-if)# bridge-group 120
soodar(config-if)# int ge0
soodar(config-if)# no shutdown
soodar(config-if)# bridge-group 120
```

```
soodar(config)# vrf green
soodar(config-vrf)# vni 40
soodar(config)# int ge1
soodar(config-if)# ip vrf forwarding green
soodar(config-if)# ip address 200.1.3.1/24
soodar(config)# interface nve 10
soodar(config-if)# source-ip 200.1.2.1
soodar(config-if)# ingress-replication 200.1.3.3
soodar(config-if)# member vni 40 associate-vrf
soodar(config-if)# bridge-group 120
soodar(config-if)# int ge0
soodar(config-if)# no shutdown
soodar(config-if)# bridge-group 120
```

## Logging

Debugging logs can be set in case of need.

### **[no] debug vxlan event**

log data plane installation processes and results

## VPLS

Virtual Private LAN Service( VPLS) is a method to extend LANs on the network. SoodarOS Supports VPLS on an MPLS core network. First, we need to create a `mpls-tunnel` interface to achieve this. This interface acts as a pseudowire by adding another *MPLS label* to its passing traffic. Using a TLDP( Targeted LDP) session, the `tunnel label` can be negotiated between two routers.

---

**Note:** To use VPLS, the connection should be full-mesh. If three router `r1`, `r2` and `r3` are going to form a VPLS, 3 connection is needed: `r1-r2`, `r2-r3` and `r1-r3`

---

### **interface mpls-tunnel**

Creates a `mpls-tunnel` interface

### **l2vpn NAME type vpls**

Create an L2VPN using VPLS technology

### **member pseudowire PW**

Add a `mpls-tunnel` to this L2VPN and enter member pseudowire configuration mode. PW is `mpls-tunnel`'s name

### **neighbor lsr-id A.B.C.D**

Target's LSR-ID of this pseudowire.

---

**Note:** We should have a route to target's LSR-ID to establish a targeted session.

---

### **pw-id (1-4294967295)**

An ID to distinguish pseudowires. If PW-IDs differ, the session will not be established.

Example :

```
soodar(config)# interface ge3
soodar(config-if)# bridge-group 200
soodar(config-if)# no shutdown
soodar(config)# interface mpls-tunnel0
soodar(config-if)# bridge-group 200 split-horizon group 100
soodar(config-if)# no shutdown
soodar(config)# interface mpls-tunnel1
soodar(config-if)# bridge-group 200 split-horizon group 100
soodar(config-if)# no shutdown
soodar(config)# mpls ldp
soodar(config-ldp)# router-id 222.1.1.1
soodar(config)# l2vpn exemplary-vpls type vpls
soodar(config-l2vpn)# member pseudowire mpls-tunnel0
soodar(config-l2vpn-pw)# neighbor lsr-id 222.7.7.7
soodar(config-l2vpn-pw)# pw-id 170
soodar(config-l2vpn)# member pseudowire mpls-tunnel1
soodar(config-l2vpn-pw)# neighbor lsr-id 222.14.14.14
soodar(config-l2vpn-pw)# pw-id 1140
```

---

**Note:** Note how mpls-tunnels share the same split-horizon group id. It's to prevent loops in packets( since bridge flooding is enabled and our topology is full-mesh).

---

## Logging

Debugging logs can be set in case of need.

### [no] debug vpls event

log data plane installation processes and results

## 1.10.2 PKI

Public Key Infrastructure manages certificates for supporting IPSec protocol. This includes: - RSA key generation. - Import Certificate Authorities. - PKCS#10 Certificate Signing Request( CSR).

---

**Note:** All PKI actions are permanent jobs; It does not appear in running config but is preserved after the router reboot.

---

---

**Note:** Currently, no certificate revocation method is supported.

---

## Key Generation

A pair of private/public keys are used for issuing certificate requests or used in other protocols.

### **crypto key generate rsa label NAME modulus (2048|4096)**

Generate a new RSA key pair and store it as NAME. The key modulus can be determined( default is 2048).

### **crypto key generate x25519 label LABEL**

Generate a new X25519 key pair and store it as LABEL.

### **crypto key generate rawraw label LABEL bytes (32-1024)**

Generate Raw bytes and store them as LABEL. The number of generated bytes can be set( default is 32).

### **crypto key generate ssh modulus (2048|4096)**

Generate a new RSA keypair to be used by SSH

## Importing a CA

First, to import a CA, we need to define a trustpoint. A trustpoint is a CA( and optionally a general-purpose certificate signed by that CA). After defining trustpoint, authentication is needed to import the CA. This certificate could be self-signed, and the SSH terminal is the input( SoodarOS administrator should copy/paste the certificate).

---

**Note:** All inputs/outputs( including certificate, CSR and ...) are in PEM format

---

### **crypto pki trustpoint NAME**

Create a new trustpoint

### **crypto pki authenticate TP**

Authenticate the trustpoint TP and write its CA to non-volatile memory.

Example :

```
n1(config)# crypto pki trustpoint root-ca
n1(config)# crypto pki authenticate root-ca
Enter the base 64 encoded CA certificate
End with a blank line or the word "quit" on a line by itself

-----BEGIN CERTIFICATE-----
MIIDSzCCAjOgAwIBAgIIQMT8Qv03sXYwDQYJKoZIhvcNAQELBQAwNTELMakGA1UE
BhMCSVIXEzARBgNVBAoTC1RlbXAgQ29ycC4xETAPBgNVBAMTCHRlbXAuY29tMB4X
DTIxMDEyMDExNDIzNFoXDTI0MDEyMDExNDIzNFowNTELMakGA1UEBhMCSVIXEzAR
BgNVBAoTC1RlbXAgQ29ycC4xETAPBgNVBAMTCHRlbXAuY29tMIIBIjANBgkqhkiG
9w0BAQEFAAOCAQ8AMIIBCgKCAQEAY1KPgdCS6BB7PCdeggnsf6NjW4KBxeG6H18R
lOHYoTBMlR3QrvCrgpgoZv3DtGR8T6Ch0/HdL1GdFJ7RcJqZPbaxdepqI08SZG4VD
CcZbI0dCNgKWD+ja00vgyfcK2cXKY70bduUuJLwNvSvPEPhzH1UNx7kfBdvGn2Vg
s/XyYhsn3xc6ioODT+HUAAd2WvBIOzd+RUo0yANJRkbPnLPgpNEiE1wG6Bj6orjR
ajnC8SYt5XGqD0DX7JGi7bELHw0JGdDk1acr9GQyJwVobDYCKDTuW4ELDSs+2GIK
E76rmlAGrJGy3po2itVbmMprhbTl3E0pxPz178qkG/r0i41UXQIDAQABO18wXTAP
BgNVHRMBAf8EBTADAQH/MA4GA1UdDwEB/wQEAWIBBjAdBgNVHQ4EFgQU7CsuL8vJ
o0kfANvQjVQkaR4K/WQwGwYDVR0RBQwEoIQb3RoZXIuZG9tYW1uLmNvbTANBgkq
hkiG9w0BAQsFAAOCAQEAE8iOUjW8+BNBCfyyfcQ0okd7UuK/0DE40wEXVRpMzyv
4IoLNNz5SmWBZo5WdtkIUfGmC9l18uRsBpIcqhOR8ZSRkjswtOFn+C5KxNXum1pQ
cLmNpxn2ecsr2K2qW6IRfig8cQwzpfE3c59zFf13gKdr6g0B+1px/hMBdhyaUn6A
```

(continues on next page)



(continued from previous page)

```

9uXtvgeCzAqdJehpo12IKNnYeL+GrfHcFe7R7BRLD2XzoAgjFR48w24h3FbrxM8I
1jqEwbvnGT7FECGZbyKGBEM/dY1gbVD19GTJlaZ8z3HrHdaRFvCYgAqFLTVtU8Q+
lq+EWiCSMRlPPx10iLDddbXrW2JIjdF7XIsU3WGhtw==
-----END CERTIFICATE-----
Updating certificates in /etc/ssl/certs...
1 added, 0 removed; done.
Running hooks in /etc/ca-certificates/update.d...
done.

n1# show crypto pki certificate root-ca
Trustpoint: root-ca
CA:
  subject: "C=IR, O=Temp Corp., CN=temp.com"
  issuer:  "C=IR, O=Temp Corp., CN=temp.com"
  validity: not before Jan 20 15:12:34 2021, not valid yet (valid in 58 seconds)
           not after  Jan 20 15:12:34 2024, ok (expires in 1095 days)
  serial:  40:c4:fc:42:fd:37:b1:76
  altNames: other.domain.com
  flags:   CA CRLSign self-signed
  subjKeyId: ec:2b:2e:2f:cb:c9:a3:49:1f:00:db:d0:8d:54:24:69:1e:0a:fd:64
  pubkey:   RSA 2048 bits
  keyid:   cf:d8:04:82:62:b9:f1:a9:84:75:56:e7:1b:5b:ac:4a:c8:ba:ae:21
  subjkey: ec:2b:2e:2f:cb:c9:a3:49:1f:00:db:d0:8d:54:24:69:1e:0a:fd:64
  Fingerprint: 954E9105EEE221C7BCDF351BBA0184E950F82C75

```

## Generate a certificate and CSR

Users can request a certificate signing and import that certificate. To do this, a trustpoint needs to have these parameters set: 1. Certificate's SN( and optionally some SANs) 2. A RSA key pair to create and sign the CSR. 3. An enrollment method. Currently, only the SSH terminal( copy and paste) method is available and could be skipped. After setting up trustpoint, and authenticating it, a CSR should be generated. If terminal enrollment is used, the PKCS#10 format CSR is printed on the screen, and SoodarOS administrator needs to copy it and sign it by a CA. To import this signed certificate, an authentication for this trustpoint is needed.

### subject-name LINE...

Certificate SN setting

### subject-alt-name LINE

Certificate SAN setting

---

**Note:** Enter the command multiple times to set multiple SANs. Up to 100 SANs are supported.

---

### no subject-alt-name LINE

Remove a SAN from trustpoint.

### rsakeypair KEY

Use previously-generated key pair KEY to sign CSR

### enrollment terminal pem

Enroll via terminal( copy and paste), including PEM encapsulation boundaries.

**crypto pki enroll TP**

Generate a Certificate Signing Request for trustpoint TP. If terminal enrollment is used, the PKCS#10 format CSR is printed on the screen

**crypto pki import TP certificate**

Import the trustpoint TP's general-purpose certificate and write it to non-volatile memory.

**Note:** Imported general-purpose certificate should be signed by the same CA that the trustpoint is authenticated, or else, it fails to import.

Example :

```
n1(config)# crypto key generate rsa label mycert-key modulus 2048
n1# show crypto key mycert-key
Keypair Label: mycert-key
  Algorithm:  RSA
  Modulus:    2048 bits
  Subject key: fcc893035eda7e736d0a612bad1d000612c87724
  Key ID:     E5611192FEAD3FDFA877A0BAC5F336480A8C2D97
n1(config)# crypto pki trustpoint mycert
n1(ca-trustpoint)# subject-name C=IR, O=My Org, CN=my.org
n1(ca-trustpoint)# subject-alt-name other.my.org
n1(ca-trustpoint)# subject-alt-name other2.my.com
n1(ca-trustpoint)# rsakeypair mycert-key
n1(config)# crypto pki authenticate mycert
Enter the base 64 encoded CA certificate
End with a blank line or the word "quit" on a line by itself

-----BEGIN CERTIFICATE-----
MIIDODCCAiCgAwIBAgIIM7DVFqEvgxgwDQYJKoZIhvcNAQELBQAwOjELMAkGA1UE
BhMCQ0gxZzARBgNVBAoTCnN0cm9uZ1N3YW4xZjAUBgNVBAMTDXN0cm9uZ1N3YW4g
Q0EwHhcNMjAxMTEzMjE0TEZwWcNMjMxMTEzMjE0TEZwWjA6MQswCQYDVQQGEwJD
SDEtMBEGA1UEChMKc3Ryb25nU3dhbjEWMBQGA1UEAxMNc3Ryb25nU3dhbiBDQTCC
ASIwDQYJKoZIhvcNAQEBBQADggEPADCCAQoCggEBANjhd9ZFscs403TcnXWfy/cr
wXnVCxev6g5XecHG0A+ja0S6MyJowjJU/CY5S8/LWKIB1KfhdswDT0LaPodnKw8e
RVGwAfQSYb80ymUeHBYzxxfhqcCjYu0qWdb2Tf9yVadkt//qW5n2F78j3prFlZ4o
pbG1sLhACY+729iJxB7dg5DKXxECBzSiMo2dScZpQKuAdiev4g7TmEH0u3MUa9zU
CzIhoqjzEJ1wF4YC7Y6BZxQU4c04RZGctaOmKRUT0NfVgBqseJHsJVZSCDFud/lS
48tDmQ08GULFNFlFAeGwCUnLle2sorsB+zjfQrJQJBtE/RuoKZ3ODK+ZwGH8wHEC
AwEAAANCMEEAwDwYDVR0TAQH/BAUwAwEB/zA0BgNVHQ8BAf8EBAMCAQYwHQYDVR00
BBYEFNET3aeJu4082kUYI8TpeBK4w61sMA0GCSqGSIb3DQEBCwUAA4IBAQC2ciJ
D197+CIwL/DveAJf7Bt0cMD21PwY4hsHUyHridX2B/t6EM00ujWPouSeBYjLbz7s
akHwh3G9Yx4w1S+k+du5AbkQHmNyige04rul+tCg7FzouxFtKEcD6T707DnSEkP+
iA9mLeKxCK3P4vGY2H9x6McqZ1aM55xmdEbvD3QhUMLePBk4aMVky0r4yWRQgUPB
oBqRVSEvthOyXEWtPkqxY720/5IQmHDSncBP/D+wiC2wQsYQZhmDoN6d740qkcBr
HMWDCUM1b8RFVBTekIKvkvQ14BgvPve099E+P6rrNhdxRA8BwmnNyMvrd81Z1FDU/
J+XkIuPRfz33v000
-----END CERTIFICATE-----
Updating certificates in /etc/ssl/certs...
1 added, 0 removed; done.
Running hooks in /etc/ca-certificates/update.d...
done.
```

(continues on next page)

(continued from previous page)

```
n1(ca-trustpoint)# enrollment terminal pem
n1(config)# crypto pki enroll mycert
-----BEGIN CERTIFICATE REQUEST-----
MIICrTCCAQUCAwLzELMAkGA1UEBhMCSVIxZDZANBgNVBAoTBk15IE9yZzEPMA0G
A1UEAxMGBXkub3JnMIIBIjANBgkqhkiG9w0BAQEFAAOCAQ8AMIIBCgKCAQEAtvWm
Xi+CtKrJndPw09hPOnT08DSDIJqi3GdcNDVRcdKb/FB+/C++Vyb2vOLNICxCmRJH
RnoZKPnWqRHwyHeVCNr+Da+bFYHXd4LyaZtCzEoUrmULMyBWGmbUfUlfFpOCa4yq
28qV1BjYXEm93X56XIaT/WpqXELihJC2nnBPxhkLHA80fLmQPZdOzytrjeJt1Rvn
I/PpI+OzEN9/pUvGLv29wzfzUN2T9WGdIY/SJuyafQ2972juRA20TTSsMSOxM4fuj
Mk116RixYvHCd454gehPKOqMUHbXKZ7tQXPADFtiQIqNqBMz4AlT40Wn3GsODV8Y
AtJ9U0vhmMW1iTHC2wIDAQABoDkwNwYJKoZIHvcNAQkOMSowKDAmBgNVHREEHzAd
ggxvdGhlci5teS5vcmeCDW90aGVyMi5teS5jb20wDQYJKoZIhvcNAQELBQADggEB
AKwvB+bPTMpU2t3HE6CA0mLA9ufc9EqWx2YCTyddTJ8Qp7xhdXyWzB64R5Um/mqy
x7lMEyS69pZzTMivm28piIEplSdjKSiHmRpVZsXGWvhpz1alqA6h5IaWlm9s3Bga
YKbmaC0uEsuhXnAxFBPtbwWSaGN0uD5kKtkwZXMxKv4gVktbrdZfZ2uJR2CiZu1q
yb7u47MeZF4xfcncvFZCuUjllmpFXMLXjYuNywJP6U/i1DpSG07mDYcnefS9Ku/o/
gdNBahSspRtBV0x4QtN4bGZ0MDEn5cEBuWcN4dnNbE30dn70NKaNe1DhdKQ/1UxQ
qyIP+5tc2i8GoJsL9wyWJIo=
-----END CERTIFICATE REQUEST-----
```

```
n1(config)# crypto pki import mycert certificate
Enter the base 64 encoded CA certificate
End with a blank line or the word "quit" on a line by itself
```

```
-----BEGIN CERTIFICATE-----
MIIDMTCCAhmGAWIBAgIIVmyRIVfPsKowDQYJKoZIhvcNAQELBQAwNTELMakGA1UE
BhMCSVIxZDZANBgNVBAoTC1RlbnAgQ29ycC4xETAPBgNVBAMTCHRlbXAuY29tMB4X
DTIxMDEyMDEyNDgzN1oXDTI0MDEyMDEyNDgzN1owLzELMAkGA1UEBhMCSVIxZDZAN
BgNVBAoTBk15IE9yZzEPMA0GA1UEAxMGBXkub3JnMIIBIjANBgkqhkiG9w0BAQEFA
AOCAQ8AMIIBCgKCAQEAtvWmXi+CtKrJndPw09hPOnT08DSDIJqi3GdcNDVRcdKb
/FB+/C++Vyb2vOLNICxCmRJHRnoZKPnWqRHwyHeVCNr+Da+bFYHXd4LyaZtCzEoU
rmULMyBWGmbUfUlfFpOCa4yq28qV1BjYXEm93X56XIaT/WpqXELihJC2nnBPxhkL
HA80fLmQPZdOzytrjeJt1RvnI/PpI+OzEN9/pUvGLv29wzfzUN2T9WGdIY/SJuyaf
Q2972juRA20TTSsMSOxM4fujMk116RixYvHCd454gehPKOqMUHbXKZ7tQXPADFti
QIqNqBMz4AlT40Wn3GsODV8YAAtJ9U0vhmMW1iTHC2wIDAQABoswSTAFBgNVHSM
E GDAWgBTsKy4vy8mjSR8A29CNVCRpHgr9ZDAmBgNVHREEHzAdggxvdGhlci5teS5v
cmeCDW90aGVyMi5teS5jb20wDQYJKoZIhvcNAQELBQADggEBAGbt3R0FyA48FWUh
eoud1zh6ujrg0PgfJ0hAMnWaln8nXdhMjJJvOI/MZtcyl7fghXr1Asr2M9I3KMxh
BbBefCci5+94g+QucP/R0v5/fzFpiV8gRYXD8o7UWyYanQG5SUyTCdpr5vXxVbEW
FXp3Yk1HBYXDe09AK9AGwRVFHTkaaPze8U5FyJpbrjDZuD/cbkN41Fn+lw49Jah0
cVqYXyY84rHjvqb98081NsittSa4QUqBNo8nUXYj+yLuNiV39Zh1pWz1/kugy0yR
mvrqC3irZGXeJbSLDaAT1LdJhiu2Axc7EjwKxcNK+GiXyN/B/7JJrWLL0u6xaA9L
ezbvqQw=
-----END CERTIFICATE-----
```

Installed successfully

```
n1# show crypto pki certificate mycert
Trustpoint: n1Cert
CA:
  subject: "C=IR, O=Temp Corp., CN=temp.com"
  issuer:  "C=IR, O=Temp Corp., CN=temp.com"
```

(continues on next page)

(continued from previous page)

```

validity: not before Jan 20 15:12:34 2021, ok
          not after Jan 20 15:12:34 2024, ok (expires in 1094 days)
serial:   40:c4:fc:42:fd:37:b1:76
altNames: other.domain.com
flags:    CA CRLSign self-signed
subjKeyId: ec:2b:2e:2f:cb:c9:a3:49:1f:00:db:d0:8d:54:24:69:1e:0a:fd:64
pubkey:   RSA 2048 bits
keyid:    cf:d8:04:82:62:b9:f1:a9:84:75:56:e7:1b:5b:ac:4a:c8:ba:ae:21
subjkey:  ec:2b:2e:2f:cb:c9:a3:49:1f:00:db:d0:8d:54:24:69:1e:0a:fd:64
Fingerprint: 954E9105EEE221C7BCDF351BBA0184E950F82C75

```

**General Purpose Certificate:**

```

subject: "C=IR, O=My Org, CN=my.org"
issuer:  "C=IR, O=Temp Corp., CN=temp.com"
validity: not before Jan 20 15:18:36 2021, ok
          not after Jan 20 15:18:36 2024, ok (expires in 1094 days)
serial:   56:6c:91:21:57:cf:b0:aa
altNames: other.my.org, other2.my.com
flags:
authkeyId: ec:2b:2e:2f:cb:c9:a3:49:1f:00:db:d0:8d:54:24:69:1e:0a:fd:64
subjKeyId: fc:c8:93:03:5e:da:7e:73:6d:0a:61:2b:ad:1d:00:06:12:c8:77:24
pubkey:   RSA 2048 bits
keyid:    e5:61:11:92:fe:ad:3f:df:a8:77:a0:ba:c5:f3:36:48:0a:8c:2d:97
subjkey:  fc:c8:93:03:5e:da:7e:73:6d:0a:61:2b:ad:1d:00:06:12:c8:77:24
Keypair:  mycert-key
Fingerprint: D51636591648DBDE21FEEFA4C6DF4B38A96502B5

```

**Self-signed Trustpoints**

Self-signed certificates are available to generate in SoodarOS PKI system. Set the enrollment method of trustpoint to selfsigned, and you are good to go. A self-signed certificate can't be imported or authenticated. Enrolling this ``trustpoint`` generates the certificate.

Example :

```

n1(config)# crypto key generate rsa label self-signed-key
n1(config)# crypto pki trustpoint self-signed-tp
n1(ca-trustpoint)# enrollment selfsigned
n1(ca-trustpoint)# rsakeypair self-signed-key
n1(ca-trustpoint)# subject-name C=IR, O=Independent Ltd., CN=self.indie.com
n1(config)# crypto pki enroll self-signed-tp
n1# show crypto pki certificate self-signed-tp
Trustpoint: self-signed-tp
CA:
  subject: "C=IR, O=Independent Ltd., CN=self.indie.com"
  issuer:  "C=IR, O=Independent Ltd., CN=self.indie.com"
  validity: not before Jan 20 15:45:09 2021, ok
            not after Jan 20 15:45:09 2024, ok (expires in 1094 days)
  serial:   15:9a:3b:16:34:f9:79:49
  flags:    CA CRLSign self-signed
  subjKeyId: 33:74:e2:a1:5e:d1:49:bf:c7:bf:f7:23:4c:c6:53:a0:07:56:24:09

```

(continues on next page)

(continued from previous page)

```
pubkey: RSA 2048 bits
keyid: bd:12:cd:f2:1a:b7:d2:27:82:26:db:51:01:d2:60:0d:48:24:bf:3d
subjkey: 33:74:e2:a1:5e:d1:49:bf:c7:bf:f7:23:4c:c6:53:a0:07:56:24:09
Fingerprint: 89177619D312F1AEFAC0A5C8B9DE5E0196B56F16
```

## Removing a private key

Admin can remove unused private keys. Removing is done securely by shredding and zeroing the key file.

### crypto key zeroize RSAKEY

Shred a key pair.

**Note:** Removing a key makes the ``trustpoint``s using them invalid. It's the admin's duty to take care of this situation and remove unused keys or remove all certificates depending on that key.

## Removing a trustpoint

Admin can remove a trustpoint. This action removes the CA and general-purpose certificate( if available) and updates the system CA database.

### no crypto pki trustpoint TPNAME

## Viewing installed Certificates and keys

After installing a certificate, one can see that certificate with a show command.

### show crypto pki certificate [CA]

Show available certificates on device. If CA name is not provided, all certificates on the system are shown.

Example :

```
n1# show crypto pki certificate mycert
Trustpoint: n1Cert
CA:
subject: "C=IR, O=Temp Corp., CN=temp.com"
issuer: "C=IR, O=Temp Corp., CN=temp.com"
validity: not before Jan 20 15:12:34 2021, ok
           not after Jan 20 15:12:34 2024, ok (expires in 1094 days)
serial: 40:c4:fc:42:fd:37:b1:76
altNames: other.domain.com
flags: CA CRLSign self-signed
subjkeyId: ec:2b:2e:2f:cb:c9:a3:49:1f:00:db:d0:8d:54:24:69:1e:0a:fd:64
pubkey: RSA 2048 bits
keyid: cf:d8:04:82:62:b9:f1:a9:84:75:56:e7:1b:5b:ac:4a:c8:ba:ae:21
subjkey: ec:2b:2e:2f:cb:c9:a3:49:1f:00:db:d0:8d:54:24:69:1e:0a:fd:64
Fingerprint: 954E9105EEE221C7BCDF351BBA0184E950F82C75

General Purpose Certificate:
subject: "C=IR, O=My Org, CN=my.org"
```

(continues on next page)

(continued from previous page)

```

issuer: "C=IR, O=Temp Corp., CN=temp.com"
validity: not before Jan 20 15:18:36 2021, ok
          not after Jan 20 15:18:36 2024, ok (expires in 1094 days)
serial: 56:6c:91:21:57:cf:b0:aa
altNames: other.my.org, other2.my.com
flags:
authkeyId: ec:2b:2e:2f:cb:c9:a3:49:1f:00:db:d0:8d:54:24:69:1e:0a:fd:64
subjkeyId: fc:c8:93:03:5e:da:7e:73:6d:0a:61:2b:ad:1d:00:06:12:c8:77:24
pubkey: RSA 2048 bits
keyid: e5:61:11:92:fe:ad:3f:df:a8:77:a0:ba:c5:f3:36:48:0a:8c:2d:97
subjkey: fc:c8:93:03:5e:da:7e:73:6d:0a:61:2b:ad:1d:00:06:12:c8:77:24
Keypair: mycert-key
Fingerprint: D51636591648DBDE21FEEFA4C6DF4B38A96502B5

```

**show crypto key [[KEY] [json]] [ssh]**

Show key information. If a key name is not provided, all keys on the system are shown. Output can be JSON( except SSH)

Example :

```

n1# show crypto key mycert-key-rsa
Keypair Label: mycert-key-rsa
  Algorithm: RSA
  Modulus: 2048 bits
  Subject key: FCC893035EDA7E736D0A612BAD1D000612C87724
  Key ID: E5611192FEAD3FDFA877A0BAC5F336480A8C2D97
n1# show crypto key x25519-key
Keypair Label: x25519-key
  Algorithm: X25519
  Public key: DEE5089576AD02780EFEF6908034E6BD471C2C6DF7FE68FC77F12C5DFCDB9D59
n1# show crypto key raw-key
Keypair Label: raw-key
  Algorithm: Raw
  Length: 256 bits
n1# show crypto key json
{
  "keys":[
    {
      "label":"mycert-key-rsa",
      "algorithm":"RSA",
      "modulus":2048,
      "subject_key":"FCC893035EDA7E736D0A612BAD1D000612C87724",
      "key_id":"E5611192FEAD3FDFA877A0BAC5F336480A8C2D97"
    },
    {
      "label":"x25519-key",
      "algorithm":"X25519",
      "public_key":"DEE5089576AD02780EFEF6908034E6BD471C2C6DF7FE68FC77F12C5DFCDB9D59"
    }
  ],
  {
    "label":"raw-key",

```

(continues on next page)

(continued from previous page)

```

    "algorithm":"RAW",
    "length":256
  }
]
}

```

### 1.10.3 Wireguard

WireGuard is a communication protocol and free and open-source software that implements encrypted virtual private networks, and was designed with ease of use, high-speed performance, and low attack surface.

SoodarOS supports Wireguard both as a wireguard server and as a wireguard client.

#### Interface

To start a wireguard tunnel, first, a wireguard interface should be created.

##### **interface wireguard (0-1023)**

Create a wireguard interface instance.

##### **wireguard source A.B.C.D**

Set wireguard tunnel source.

##### **wireguard private-key X25519KEY**

Use x25519 key with X25519KEY label as wireguard private key.

##### **wireguard port (1000-65535)**

Wireguard's UDP listens port. If not provided, use 51820 as the port.

#### Server

Each wireguard server instance can have multiple peers. Each peer consists of its public-key and allowed IPs( IP ranges that should be routed via tunnel).

##### **wireguard peer PEER**

Create a wireguard peer named PEER

##### **public-key LINE [base64]**

Peer's x25519 public key in hexadecimal or base64

##### **allowed-ip A.B.C.D/M**

Add A.B.C.D/M to peer's allowed IP ranges.

---

**Note:** multiple ranges can be added by issuing allowed-ip command multiple times.

---

##### **no allowed-ip [A.B.C.D/M]**

Remove A.B.C.D/M from peer's allowed IP ranges. If run without any input, remove all allowed IPs.

##### **vrf VRF**

Lookup peer destination in VRF's FIB.

## Client

A wireguard client instance has only one peer, and its peer is the server. This peer should have public-key, allowed IPs( IP ranges that should be routed via tunnel), the server address and its listening port.

**[no] endpoint A.B.C.D port (1000-65535)**

Set/remove peer's endpoint address and port.

## Debug

Admin can see wireguard status by using `show wireguard` command.

**show wireguard [(1-1024) PEER] [json]**

Show wireguard status. If the instance is not indicated, show all wireguards and their peers' status. Users can specify which instance and which peer of that instance is in their interest. By adding `json` option to the command, output transforms to JSON.

```
server# show wireguard
Wireguard 10
  Source: 200.1.3.1
  Key: key1
  Public key: 7D61BA2FA556FD7B4AA0D54114575DF6FBC5AB9B96337C4A438E85CDFC77ED7C
  Port: 5100

Peer n3:
  Public key: 950A6657CDE2193C786FF4771A46318AB86B9CB60BA071E344E8C094EBEEF662
  Persistent keepalive: 25
  Allowed IPs:
    - 3.1.1.0/24
Wireguard 20
  Source: 200.1.2.1
  Key: key2
  Public key: DF6DEA63D7F5E11F9115C1CAA08D78FAFE6BA003739952B8094BC7AE744D235A
  Port: 5100

Peer n2:
  Public key: 1D819A6950BBC16F04D86FBF8AA660434AEE12D77888E2F534641E9E7C51EEE2
  Persistent keepalive: 25
  Allowed IPs:
    - 2.1.1.0/24
server# show wireguard 20
Wireguard 20
  Source: 200.1.2.1
  Key: key2
  Public key: DF6DEA63D7F5E11F9115C1CAA08D78FAFE6BA003739952B8094BC7AE744D235A
  Port: 5100

Peer n2:
  Public key: 1D819A6950BBC16F04D86FBF8AA660434AEE12D77888E2F534641E9E7C51EEE2
  Persistent keepalive: 25
  Allowed IPs:
    - 2.1.1.0/24
n3# show wireguard 10 server
```

(continues on next page)



(continued from previous page)

```

Wireguard 10
Peer server:
  Public key: 7D61BA2FA556FD7B4AA0D54114575DF6FBC5AB9B96337C4A438E85CDFC77ED7C
  Endpoint: 200.1.3.1
  Persistent keepalive: 25
  Port: 5100
  Allowed IPs:
    - 1.1.1.0/24
server# show wireguard json
{
  "wireguards":[
    {
      "instance":10,
      "source":"200.1.3.1",
      "key":"temp",
      "public_key":"7D61BA2FA556FD7B4AA0D54114575DF6FBC5AB9B96337C4A438E85CDFC77ED7C",
      "port":5100,
      "peers":[
        {
          "name":"n3",
          "public_key":"950A6657CDE2193C786FF4771A46318AB86B9CB60BA071E344E8C094EBEEF662
↵",
          "endpoint":"0.0.0.0",
          "keepalive":25,
          "port":0,
          "allowed_ips":[
            "3.1.1.0/24"
          ]
        }
      ]
    }
  ],
  {
    "instance":20,
    "source":"200.1.2.1",
    "key":"temp",
    "public_key":"DF6DEA63D7F5E11F9115C1CAA08D78FAFE6BA003739952B8094BC7AE744D235A",
    "port":5100,
    "peers":[
      {
        "name":"n2",
        "public_key":"1D819A6950BBC16F04D86FBF8AA660434AEE12D77888E2F534641E9E7C51EEE2
↵",
        "endpoint":"0.0.0.0",
        "keepalive":25,
        "port":0,
        "allowed_ips":[
          "2.1.1.0/24"
        ]
      }
    ]
  }
]
}
]

```

(continues on next page)

}

```
show wireguard [(1-1024) PEER] stats [json]
```

```
n1# show wireguard stats
Wireguard 10
Peer n2:
  Packets received: 0 packets, 0 bytes
  Packets transmitted: 36 packets, 5328 bytes

Peer n1:
  Packets received: 0 packets, 0 bytes
  Packets transmitted: 0 packets, 0 bytes

Peer n3:
  Packets received: 27 packets, 1676 bytes
  Packets transmitted: 25 packets, 1568 bytes
n1# show wireguard 10 n3 stats
Wireguard 10
Peer n3:
  Packets received: 36 packets, 2196 bytes
  Packets transmitted: 31 packets, 1880 bytes
n1# show wireguard 10 n3 stats json
{
  "wireguards":[
    {
      "instance":10,
      "peers":[
        {
          "name":"n3",
          "rx_packets":36,
          "rx_bytes":2196,
          "tx_packets":31,
          "tx_bytes":1880
        }
      ]
    }
  ]
}
```

### Example

In the following scenario, we want to establish a wireguard server with 3 clients.

First, we create an x25519 private key in the server:

```
server(config)# crypto key generate x25519 label server-key
server# show crypto key server-key
Keypair Label: server-key
Algorithm: X25519
Public key: D889D845BEED407332B486A1C0A36D310781DD6BE2BB48855636125F16FC8142
```

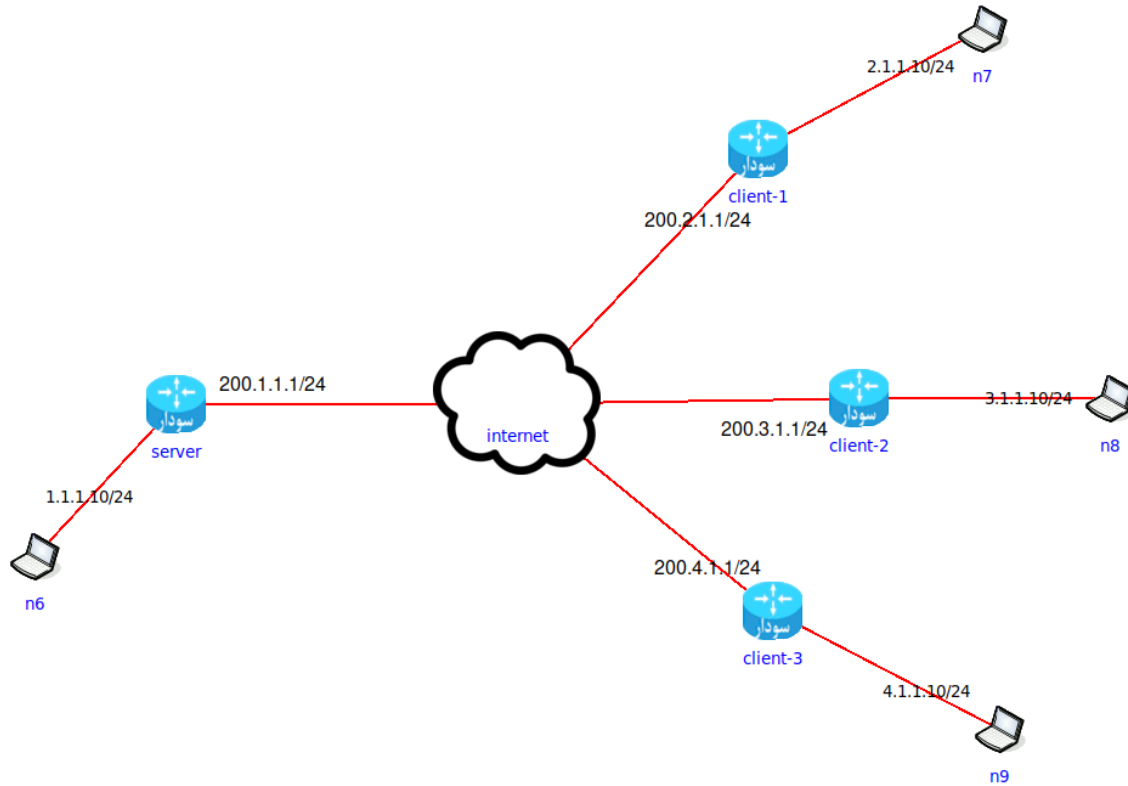

Then we set up wireguard interface:

```
server(config)# interface wireguard 10
server(config-if)# wireguard source 200.1.1.1
server(config-if)# wireguard private-key server-key
server(config-if)# wireguard port 51820
```

Now we need to set up peers:

```
client-1(config)# crypto key generate x25519 label client1-key
client-1# show crypto key client1-key
Keypair Label: client1-key
  Algorithm:  X25519
  Public key:  85DC0E1B1E8FA87B544863BD44FB7809B85853E4B1FF16E0EFAC70990BA17467
client-1(config)# interface wireguard 1
client-1(config-if)# wireguard private-key client1-key
client-1(config-if)# wireguard source 200.2.1.1
client-1(config-if)# wireguard port 51820
client-1(config-if)# wireguard peer server
client-1(config-wg-peer)# allowed-ip 1.1.1.0/24
client-1(config-wg-peer)# public-key
↳ D889D845BEED407332B486A1C0A36D310781DD6BE2BB48855636125F16FC8142
client-1(config-wg-peer)# endpoint 200.1.1.1 port 51820
```

We do the same thing for the remaining two clients.

Now that peers are set up, we add peer information to the server:

```

server(config)# interface wireguard 10
server(config-if)# wireguard peer client-1
server(config-wg-peer)# allowed-ip 0.0.0.0/0
server(config-wg-peer)# public-key
↪85DC0E1B1E8FA87B544863BD44FB7809B85853E4B1FF16E0EFAC70990BA17467
server(config-if)# wireguard peer client-2
server(config-wg-peer)# allowed-ip 0.0.0.0/0
server(config-wg-peer)# public-key
↪5A0882D0D6B757692FDCDFC7BB2413042A333F96EECEE34B69D0E2D7107C7672
server(config-if)# wireguard peer client-3
server(config-wg-peer)# allowed-ip 0.0.0.0/0
server(config-wg-peer)# public-key
↪87BC5D410DCDED2D5A9CC443053AC2888947E9724C247CE1FCBE40E12A400293

```

Now on the first packet from each client to 1.1.1.0/24, the tunnel establishes.

### 1.10.4 IKEv2

IKEv2( Internet Key Exchange version 2) is a protocol that establishes and handles SAs( Security Association). Usually, these SAs are used with IPSec( in fact, IKEv2 is based on IPSec).

Like IPSec, IKEv2 uses a modular CLI for configuration.

#### **crypto ikev2 dpd (1-3600)**

Set IKEv2 dead peer detection parameters. The first parameter indicates how often a liveness check is performed.

#### **IKEv2 proposal**

A proposal consists of a suite of encryption/ HMAC algorithms for IKEv2 SA creation. Along with the IPSec transform set, they define the IKEv2/IPSec algorithm suite, and it's the first thing that is negotiated in IKEv2.

#### **crypto ikev2 proposal IKEPOSAL**

Create a new IKEV2 proposal named IKEPOSAL

#### **encryption ALGORITHM**

Use ALGORITHM as an encryption algorithm for IKEv2 SA creation and negotiation.

#### **integrity ALGORITHM**

Use ALGORITHM as HMAC algorithm for IKEv2 SA creation and negotiation.

#### **group GROUP**

Use GROUP as Diffie-Hellman group.

Example :

```

soodar(config)# crypto ikev2 proposal sample-proposal
soodar(config-ikev2-proposal)# encryption aes-192
soodar(config-ikev2-proposal)# integrity sha1-96
soodar(config-ikev2-proposal)# group 28

```

## IKEv2 keyring

As the name suggests, this struct holds the identity of peers, their address, and authentication materials.

### **crypto ikev2 keyring IKEKEYRING**

Create a new IKEV2 keyring named IKEKEYRING

### **peer PEER**

Create a new peer in keyring as PEER

### **pre-shared-key LINE**

Set peer's PSK value for authentication

### **identity address <A.B.C.D|X:X::X:X>**

Use an address as the peer's identity. This identity is used in negotiation and by the other peer to identify the other.

### **identity fqdn FQDN**

Use an FQDN as the peer's identity. This identity is used in negotiation and by the other peer to identify the other.

### **identity email MAIL**

Use a mail address as the peer's identity. This identity is used in negotiation and by the other peer to identify the other.

Example :

```
soodar(config)# crypto ikev2 keyring keyring-1
soodar(config-ikev2-keyring)# peer PC-1
soodar(config-ikev2-keyring-peer)# identity email home@sweet.home
soodar(config-ikev2-keyring-peer)# pre-shared-key 123@321
soodar(config-ikev2-keyring)# peer PC-2
soodar(config-ikev2-keyring-peer)# identity address 1.1.1.1
soodar(config-ikev2-keyring-peer)# pre-shared-key ITSAHARDPASSWD!!
```

## IKEv2 profile

Main struct of IKEv2.

### **match address local A.B.C.D**

Send IKEv2 packets using this address. If it's not set, the packets can use any IP address available on the router.

---

**Note:** It's a good practice to set local addresses explicitly. It can prevent problems caused by changes in routes, leading to a change in the source IP address of packets and being rejected by an IKEv2 peer.

---

### **identity local address <A.B.C.D|X:X::X:X>**

Define an address as the local identity. During the IKEv2 session, the router introduces himself by this identity to its peer.

### **identity local fqdn FQDN**

Define an FQDN as the local identity. During the IKEv2 session, the router introduces himself by this identity to its peer.

**identity local email MAIL**

Define a mail address as the local identity. During the IKEv2 session, the router introduces himself by this identity to its peer.

**authentication local rsa-sig**

Use RSA Digital Signature as authentication method during init.

---

**Note:** The chosen certificate to use is the one that has the same SAN as local identity

---

**authentication local pre-share**

Use Shared Key Message Integrity Code as authentication method during init.

**authentication remote rsa-sig**

Expect RSA Digital Signature from the peer as authentication method during init.

**authentication remote pre-share**

Expect Shared Key Message Integrity Code from the peer as authentication method during init.

**match identity remote address <A.B.C.D|X:X::X:X>**

The expected remote identity. Other information about this peer is looked up in keyring.

**match identity remote fqdn FQDN**

The expected remote identity. Other information about this peer is looked up in keyring.

**match identity remote email EMAIL**

The expected remote identity. Other information about this peer is looked up in keyring.

**match certificate**

Match against DN fields and values as peer identity. using wildcards are allowed

---

**Note:** The peer should use RSA Digital Signature as authentication method, and it should use its DN as identity.

---

Example:

```
soodar(config-ikev2-profile)# match certificate C=IR, CN=*.temp.ir
```

Match against all peers that have DN as their identity and this certificate is issued from Iran and is a sub-domain of temp.ir

**keyring local IKEKEYRING**

Use keyring IKEKEYRING for peer lookup.

**proposal IKEPOSAL**

Use IKEPOSAL for IKEv2 SA.

**lifetime <120-86400>**

Set IKEv2 profile lifetime. Cause a rekey action to take place when the life timer exceeds.

Example :

```
soodar(config)# crypto ikev2 profile VPN
soodar(config-ikev2-profile)# identity local 192.168.1.1
soodar(config-ikev2-profile)# match identity remote home@sweet.home
soodar(config-ikev2-profile)# keyring local keyring-1
soodar(config-ikev2-profile)# proposal sample-proposal
```

## 1.10.5 IPsec

### Transform set

Define authentication and encryption algorithms

```
crypto ipsec transform-set IPSECTS ah hmac HMAC_ALG
```

Use AH mode

```
crypto ipsec transform-set IPSECTS esp {hmac HMAC_ALG |cipher CIPHER_ALG}
```

Use ESP mode. HMAC algorithm is not needed/ignored when using GCM cipher algorithms.

### mode transport

In transport mode, the Original IP header is not changed. Only AH or ESP header is added.

### Profile

Store encryption/decryption keys.

There are two ways of establishing SAs for IPsec: using static pre-defined keys and IKEv2 profiles. One should choose just one method, and using 2 methods yields inconsistency.

```
[no] crypto ipsec profile IPSECPROFILE
```

Create a new profile IPSECPROFILE.

```
[no] set transform-set IPSECTS
```

---

**Note:** An IPsec profile without Transform set is useless.

---

```
[no] set ikev2 profile IKEPROFILE
```

Set profile's IKEv2 profile to establish an IKEv2 session and SAs.

---

**Note:** An IKEv2 profile should be exclusive to one profile. And a profile using an IKEv2 profile should be bound to a tunnel and can't be used on two tunnels. So for each tunnel, we need an IKEv2 profile and an IPsec profile.

---

```
set security-association lifetime second (120-28800)
```

When using IKEv2, set SA rekeying criterion as time.

---

**Note:** IPsec SAs are installed when the IPsec profile protects a tunnel.

---

### Example: Setup an IPsec profile using IKEv2 and PSK

```
soodar1(config)# crypto ikev2 proposal PROPOSAL
soodar1(config-ikev2-proposal)# integrity sha-96
soodar1(config-ikev2-proposal)# encryption des
soodar1(config-ikev2-proposal)# group 28
soodar1(config-ikev2-proposal)# crypto ikev2 keyring KEY-1
soodar1(config-ikev2-keyring)# peer PC-1
soodar1(config-ikev2-keyring-peer)# address 200.1.2.1
```

(continues on next page)

(continued from previous page)

```

soodar1(config-ikev2-keyring-peer)# idnetity email pc1@local.net
soodar1(config-ikev2-keyring-peer)# pre-shared-key PSKPASS
soodar1(config-ikev2-keyring-peer)# crypto ikev2 profile profile-ike
soodar1(config-ikev2-profile)# identity local address 9.9.9.9
soodar1(config-ikev2-profile)# match identity remote email pc1@local.net
soodar1(config-ikev2-profile)# keyring local KEY-1
soodar1(config-ikev2-profile)# proposal PROPOSAL
soodar1(config)# crypto ipsec profile ipsec-transport-profile
soodar1(ipsec-profile)# set transform-set ipsec-tunnel-TS
soodar1(ipsec-profile)# set ikev2 profile profile-ike

```

and in the other router:

```

soodar2(config)# crypto ikev2 proposal PROPOSAL
soodar2(config-ikev2-proposal)# integrity sha-96
soodar2(config-ikev2-proposal)# encryption des
soodar2(config-ikev2-proposal)# group 28
soodar2(config-ikev2-proposal)# crypto ikev2 keyring KEY-1
soodar2(config-ikev2-keyring)# peer PC-2
soodar2(config-ikev2-keyring-peer)# idnetity address 9.9.9.9
soodar2(config-ikev2-keyring-peer)# pre-shared-key PSKPASS
soodar2(config-ikev2-keyring-peer)# crypto ikev2 profile profile-ike
soodar2(config-ikev2-profile)# identity local email pc1@local.net
soodar2(config-ikev2-profile)# match identity remote address 9.9.9.9
soodar2(config-ikev2-profile)# keyring local KEY-1
soodar2(config-ikev2-profile)# proposal PROPOSAL
soodar2(config)# crypto ipsec profile ipsec-transport-profile
soodar2(ipsec-profile)# set transform-set ipsec-tunnel-TS
soodar2(ipsec-profile)# set ikev2 profile profile-ike

```

### Example: Setup an IPSec profile using IKEv2 and RSA-Sig

We have 2 routers, soodar1 and soodar2. We have a valid CA and a signed certificate for authentication on each of them. soodar1's certificate has n1.local.net as SAN, `` and `` soodar2's certificate has n2.local.net as SAN:

```

soodar1(config)# crypto ikev2 proposal PROPOSAL
soodar1(config-ikev2-proposal)# integrity sha-384
soodar1(config-ikev2-proposal)# encryption aes
soodar1(config-ikev2-proposal)# group 28
soodar1(config)# crypto ikev2 profile profile-ike
soodar1(config-ikev2-profile)# identity local fqdn n1.local.net
soodar1(config-ikev2-profile)# lifetime 2400
soodar1(config-ikev2-profile)# match identity remote fqdn n2.local.net
soodar1(config-ikev2-profile)# authentication local rsa-sig
soodar1(config-ikev2-profile)# authentication remote rsa-sig
soodar1(config-ikev2-profile)# proposal PROPOSAL
soodar1(config)# crypto ipsec profile ipsec-transport-profile
soodar1(ipsec-profile)# set transform-set ipsec-tunnel-TS
soodar1(ipsec-profile)# set ikev2 profile profile-ike

```

and in the other router:



```

soodar2(config)# crypto ikev2 proposal PROPOSAL
soodar2(config-ikev2-proposal)# integrity sha-384
soodar2(config-ikev2-proposal)# encryption aes
soodar2(config-ikev2-proposal)# group 28
soodar2(config)# crypto ikev2 profile profile-ike
soodar2(config-ikev2-profile)# identity local fqdn n2.local.net
soodar2(config-ikev2-profile)# lifetime 2400
soodar2(config-ikev2-profile)# match identity remote fqdn n1.local.net
soodar2(config-ikev2-profile)# authentication local rsa-sig
soodar2(config-ikev2-profile)# authentication remote rsa-sig
soodar2(config-ikev2-profile)# proposal PROPOSAL
soodar2(config)# crypto ipsec profile ipsec-transport-profile
soodar2(ipsec-profile)# set transform-set ipsec-tunnel-TS
soodar2(ipsec-profile)# set ikev2 profile profile-ike

```

## Logging

Debugging logs can be set in case of need.

### [no] debug ipsec event

log data plane installation processes and results

### [no] debug ipsec vici json

log all incoming VICI messages as json

### [no] debug ipsec vici detail

log all incoming VICI messages as json and raw

## 1.11 L2 Features

### 1.11.1 L2 Abilities

#### ARP Table

An ARP table is a database of received ARP messages. It contains a group of mappings between IP addresses and MAC addresses. Each ARP entry has four fields: L3 Address ( IP Address), L2 Address ( MAC Address), Interface, and State.

Entry States are:

- Permanent: This entry never expires and doesn't need verification.
- Noarp: Normally expires but doesn't need verification.
- Reachable: Verified and will normally expire.
- Stale: Still usable but needs verification.
- Delay: ARP request is scheduled.
- Probe: ARP request is sending.
- Incomplete: First ARP request sent.

### **show ip arp [IFNAME]**

Show current system ARP table, possibly only for IFNAME interface.

Example:

### **clear ip arp [IFNAME A.B.C.D]**

Clear all ARP table entries or just the given IP address from the given interface.

## **VLAN**

VLAN allows user to segment a LAN into different broadcast domains.

### **Subinterfaces**

To create a VLAN, first we need a subinterface

#### **interface IFNAME.(0-4095)**

Creates a subinterface on interface IFNAME.

Example :

```
soodar(config)# interface ge1.100
```

#### **encapsulation dot1q (1-4094) [exact] [second-dot1q (1-4094)]**

Encapsulate packets with one( or two, if specified) VLAN tags. Drop the input packets that do not have the same tag. If **exact** is specified, input packets must have the same number of VLAN tags as the configuration.

---

**Note:** Although we can add two tags, it's a good practice to use dot1ad encapsulation for this purpose since dot1q was designed for one tag, and adding two tags, heavily depends on router implementation and its configuration.

---

---

**Note:** A subinterface before this command is not ready to use and can't be added to bridges.

---

#### **encapsulation dot1ad (1-4094) dot1q (1-4094)**

Use Q-in-Q encapsulation mode to add two tags.

#### **encapsulation default**

All packets with VLAN IDs not matched to other subinterfaces are sent to this subinterface

Example :

```
soodar(config)# interface ge1.100
soodar(config-if)# encapsulation dot1q 100
soodar(config-if)# ip address 200.1.2.20/24
soodar(config-if)# interface ge1.200
soodar(config-if)# encapsulation default
```

## Tag rewrite

An interface can be set up to add or remove( and in the future, translate) VLAN tags.

**[no] rewrite tag push <1|2> <dot1q|dot1ad> (0-4095) [(0-4095)]**

Push 1 or 2 tags to ingress traffic. The no form negates all changes caused by this command.

---

**Note:** if dot1ad is used, only the first tag is dot1ad and the second tag is dot1q

---

**[no] rewrite tag pop <1|2>**

Pop 1 or 2 tags from ingress traffic. The no form negates all changes caused by this command.

Example :

```
soodar(config)# int ge2
soodar(config-if)# rewrite tag push 1 dot1q 300
```

## Bridge

A bridge is a tool for connecting two segments of LAN.

### Add an interface to a bridge

**bridge-group (1-65535) [split-horizon group (0-255)]**

Add an interface to a bridge-group. The bridge-group is identified by a number. When a new packet arrives at the interface, if the destination MAC address is not available in the bridge-group MAC table, the packet is flooded to all interfaces in the same bridge-group( except the one from which it was received and the ones who share the same split-horizon group with interface). A split-horizon group of 0 means the interface is not in any split-horizon group and is the default value for SHG.

Example : .. code-block:: frr

```
n1(config-if)# bridge-group 600 split-horizon group 2
```

### Debugging bridge

**show bridge (1-65535)**

Example :

```
n1(config)# do sh bridge 600
```

Domain	Interface	Split-Horizon Group	BVI
600	loopback4	0	*
	ge1	0	-

### SPAN

Port monitoring tool. It mirrors source interfaces input to the destination interface.

#### Configuration

Each monitor session can have multiple source interfaces. But only one destination interface.

**[no] monitor session (1-66) source interface INTERFACE [both|rx|tx]**

Add interface INTERFACE to session. By default, both traffics are mirrored. But one can change the behavior by implying RX, TX, or both. The no form removes an interface from the monitor session.

---

**Note:** A session is not established unless a valid destination is available.

---

**monitor session (1-66) destination interface INTERFACE**

Add interface INTERFACE as session's destination port

Example :

```
soodar(config)# monitor session 12 source interface ge0
soodar(config)# monitor session 12 destination interface ge3
soodar(config)# interface ge3
soodar(config-if)# no shutdown
```

---

**Note:** Since the exact packet is mirrored on port( without changing anything), it's crucial that the interface in the receiver side is in promiscuous mode

---

### Logging

Debugging logs can be set in case of need.

**[no] debug vlan event**

log data plane installation processes and results

**[no] debug bridge event**

log data plane installation processes and results

**[no] debug span event**

log data plane installation processes and results

### 1.11.2 LACP

Link Aggregation Control Protocol is an L2-layer protocol to aggregate two or more interfaces traffic. It also introduces link redundancy.

## Bundle interface

As the name suggests, it's an interface resulting from bonding interfaces.

### **interface bundle-ether (1-65535)**

Create a bundle-ether interface with the given bundle id

#### **set mode <rr|xor|active-backup|broadcast|lacp> <l2|l23|l34>**

Set bundle-ether interface action mode. The first input determines the bonding algorithm, and the second is the load-balancing algorithm. LB is available on LACP and XOR bonding algorithms.

**rr** is *round-robin*. Packets are sent through slave interfaces in a round-robin manner.

In **active-backup** mode, all packets are sent through the first available interface and reserved.

**bradcast** mode sends all packets through all slave interfaces.

**xor** and **lacp** mode are the same. Packets are sent via different slaves based on determined flows.

**l2** load balancing, classify packet to flows by their source and destination MAC addresses.

**l23** load balancing, classify packet to flows by source and destination MAC addresses and source and destination IP addresses.

**l34** load balancing, classify packet to flows by their source and destination IP addresses, protocol and if available, TCP/UDP source and destination port number.

Default values are LACP using Layer3-Layer4 load balancing.

## Enslave an interface

### **[no] bundle id (1-65535)**

Enslave an interface to the bundle interface with the given ID. The **no** form detaches an interface from the bundle.

---

**Note:** Slave interface should be up.

---



---

**Note:** Slave interfaces should not have any valid IPs any subinterface and should not be in a bridge group.

---



---

**Note:** Subinterfaces should be created on **bundle-ether** interfaces.

---

Example :

```
soodar(config)# interface ge0
soodar(config-if)# bridge-group 100
soodar(config-if)# quit
soodar(config)# interface ge1
soodar(config-if)# ip address 10.0.0.1/16
soodar(config-if)# quit
soodar(config)# interface bundle-ether 55
soodar(config-if)# set mode lacp l23
soodar(config-if)# ip address 192.168.1.22/24
soodar(config-if)# quit
soodar(config)# interface ge0
```

(continues on next page)

(continued from previous page)

```
soodar(config-if)# no shutdown
soodar(config-if)# no bridge-group 100
soodar(config-if)# bundle id 55
soodar(config-if)# quit
soodar(config)# interface ge0
soodar(config-if)# no ip address 10.0.0.1/16
soodar(config-if)# bundle id 55
```

## Logging

Debugging logs can be set in case of need.

### **[no] debug bond event**

log data plane installation processes and results

## INDICES AND TABLES

- genindex
- search





## BIBLIOGRAPHY

- [Draft-IETF-uttaro-idr-bgp-persistence] <<https://tools.ietf.org/id/draft-uttaro-idr-bgp-persistence-04.txt>>
- [Draft-IETF-agrewal-idr-accept-own-nexthop] <<https://tools.ietf.org/id/draft-agrewal-idr-accept-own-nexthop-00.txt>>
- [Draft-IETF-idr-link-bandwidth] <<https://tools.ietf.org/html/draft-ietf-idr-link-bandwidth>>
- [Draft-IETF-mohanty-bess-ebgp-dmz] <<https://tools.ietf.org/html/draft-mohanty-bess-ebgp-dmz>>
- [bgp-route-osci-cond] McPherson, D. and Gill, V. and Walton, D., “Border Gateway Protocol (BGP) Persistent Route Oscillation Condition”, IETF RFC3345
- [stable-flexible-ibgp] Flavel, A. and M. Roughan, “Stable and flexible iBGP”, ACM SIGCOMM 2009
- [ibgp-correctness] Griffin, T. and G. Wilfong, “On the correctness of iBGP configuration”, ACM SIGCOMM 2002



## Symbols

- (1-4294967295) <deny|permit> PROTOSERVICE  
     <any|A.B.C.D/M> <any|A.B.C.D/M>  
     [exact-match], 179  
     configuration command, 179
- (1-4294967295) <deny|permit>  
     <any|A.B.C.D/M>, 178  
     configuration command, 178
- (1-4294967295) <deny|permit>  
     <any|A.B.C.D/M> <any|A.B.C.D/M>  
     [exact-match], 178  
     configuration command, 178
- (1-4294967295) <deny|permit> icmp  
     <any|A.B.C.D/M> <any|A.B.C.D/M>  
     ICMP\_TYPE\_CODES [exact-match]", 179  
     configuration command, 179
- (1-4294967295) <deny|permit> tcp  
     <any|A.B.C.D/M> SRC\_PORT  
     <any|A.B.C.D/M> DST\_PORT  
     [tcp-flag-mask (0-255)] [TCP FLAGS]  
     [exact-match], 179  
     configuration command, 179
- (1-4294967295) <deny|permit> udp  
     <any|A.B.C.D/M> SRC\_PORT  
     <any|A.B.C.D/M> DST\_PORT  
     [exact-match], 179  
     configuration command, 179
- [no] <ip|ipv6> router isis WORD [vrf NAME],  
     128  
     configuration command, 128
- [no] address-family [ipv4 | ipv6], 120  
     configuration command, 120
- [no] bgp default ipv4-unicast, 74, 80  
     configuration command, 74, 80
- [no] bgp default show-hostname, 80  
     configuration command, 80
- [no] bgp default show-nexthop-hostname, 80  
     configuration command, 80
- [no] bgp disable-ebgp-connected-route-check,  
     67  
     configuration command, 67
- [no] bgp ebgp-requires-policy, 66  
     configuration command, 66
- [no] bgp fast-external-failover, 80  
     configuration command, 80
- [no] bgp listen range  
     <A.B.C.D/M|X:X::X:X/M> peer-group  
     PGNAME, 77  
     configuration command, 77
- [no] bgp network import-check, 73  
     configuration command, 73
- [no] bgp reject-as-sets, 67  
     configuration command, 67
- [no] bgp shutdown [message MSG...], 73  
     configuration command, 73
- [no] bundle id (*I-65535*), 209  
     configuration command, 209
- [no] coalesce-time (*0-4294967295*), 77  
     configuration command, 77
- [no] crypto ipsec profile IPSECPROFILE, 203  
     configuration command, 203
- [no] debug acl event  
     configuration command, 181
- [no] debug bfd network, 61  
     configuration command, 61
- [no] debug bfd peer, 61  
     configuration command, 61
- [no] debug bfd zebra, 62  
     configuration command, 62
- [no] debug bgp bestpath  
     <A.B.C.D/M|X:X::X:X/M>, 93  
     configuration command, 93
- [no] debug bgp keepalives, 93  
     configuration command, 93
- [no] debug bgp neighbor-events, 93  
     configuration command, 93
- [no] debug bgp nht, 93  
     configuration command, 93
- [no] debug bgp update-groups, 93  
     configuration command, 93
- [no] debug bgp updates, 93  
     configuration command, 93
- [no] debug bgp zebra, 93  
     configuration command, 93

- [no] debug bond event  
configuration command, 210
- [no] debug bridge event  
configuration command, 208
- [no] debug dplane fib, 26  
configuration command, 26
- [no] debug dplane ipsec, 26  
configuration command, 26
- [no] debug ipfix event  
configuration command, 41
- [no] debug ipsec event  
configuration command, 205
- [no] debug ipsec vici detail  
configuration command, 205
- [no] debug ipsec vici json  
configuration command, 205
- [no] debug mpls ldp KIND  
configuration command, 122
- [no] debug nat44 event  
configuration command, 174
- [no] debug qos event  
configuration command, 177
- [no] debug service dhcp4, 26  
configuration command, 26
- [no] debug service mender, 26  
configuration command, 26
- [no] debug service ntpd, 26  
configuration command, 26
- [no] debug service snmp, 26  
configuration command, 26
- [no] debug span event  
configuration command, 208
- [no] debug tunnel event  
configuration command, 184
- [no] debug vlan event  
configuration command, 208
- [no] debug vpls event  
configuration command, 187
- [no] debug vrf event  
configuration command, 182
- [no] debug vxlan event  
configuration command, 186
- [no] default-router A.B.C.D ...  
configuration command, 43
- [no] discovery hello holdtime HOLDTIME, 120  
configuration command, 120
- [no] discovery hello interval INTERVAL, 120  
configuration command, 120
- [no] discovery transport-address A.B.C.D |  
A:B::C:D, 120  
configuration command, 120
- [no] dns-server A.B.C.D ...  
configuration command, 43
- [no] domain-name NAME  
configuration command, 43
- [no] dual-stack transport-connection prefer  
ipv4, 120  
configuration command, 120
- [no] echo-mode, 55  
configuration command, 55
- [no] endpoint A.B.C.D port (1000-65535)  
configuration command, 196
- [no] included-address A.B.C.D A.B.C.D  
configuration command, 43
- [no] interface IFACE, 120  
configuration command, 120
- [no] ip dhcp pool DHCP4POOL  
configuration command, 42
- [no] ip dhcp server  
configuration command, 44
- [no] ip host NAME A.B.C.D  
configuration command, 8
- [no] ip igmp watermark-warn (10-60000), 166  
configuration command, 166
- [no] ip msdp mesh-group WORD member A.B.C.D,  
166  
configuration command, 166
- [no] ip msdp mesh-group WORD source A.B.C.D,  
166  
configuration command, 166
- [no] ip msdp mesh-group [WORD], 166  
configuration command, 166
- [no] ip name-server A.B.C.D  
configuration command, 8
- [no] ip pim use-source A.B.C.D, 167  
configuration command, 167
- [no] ipv6 nd adv-interval-option  
configuration command, 39
- [no] ipv6 nd dnssl domain-name-suffix  
[lifetime]  
configuration command, 39
- [no] ipv6 nd home-agent-config-flag  
configuration command, 39
- [no] ipv6 nd home-agent-lifetime  
[(0-65520)]  
configuration command, 39
- [no] ipv6 nd home-agent-preference  
[(0-65535)]  
configuration command, 39
- [no] ipv6 nd managed-config-flag  
configuration command, 38
- [no] ipv6 nd mtu [(1-65535)]  
configuration command, 39
- [no] ipv6 nd other-config-flag  
configuration command, 38
- [no] ipv6 nd ra-fast-retrans  
configuration command, 38
- [no] ipv6 nd ra-hop-limit [(0-255)]

- configuration command, 38
- [no] ipv6 nd ra-interval [(1-1800)] configuration command, 38
- [no] ipv6 nd ra-interval [msec (70-1800000)] configuration command, 38
- [no] ipv6 nd ra-lifetime [(0-9000)] configuration command, 38
- [no] ipv6 nd ra-retrans-interval [(0-4294967295)] configuration command, 38
- [no] ipv6 nd rdns ipv6address [lifetime] configuration command, 39
- [no] ipv6 nd reachable-time [(1-3600000)] configuration command, 38
- [no] ipv6 nd router-preference [(high|medium|low)] configuration command, 39
- [no] lease <(0-365) (0-23) (0-59)|infinite> configuration command, 43
- [no] log commands, 28 configuration command, 28
- [no] log facility [FACILITY] configuration command, 28
- [no] log file [LEVEL] configuration command, 27
- [no] log monitor [LEVEL] configuration command, 27
- [no] log record-priority configuration command, 28
- [no] log rotate max-file-life (1-1000), 27 configuration command, 27
- [no] log rotate max-retention (1-1000), 27 configuration command, 27
- [no] log syslog HOST loki [skip-host-verify] [port (100-65535)] configuration command, 27
- [no] log syslog [A.B.C.D|HOST] tcp [tls [skip-host-verify]] [port (100-65535)] configuration command, 27
- [no] log syslog [LEVEL] configuration command, 27
- [no] log timestamp precision (0-6), 28
- [no] log timestamp precision [(0-6)] configuration command, 28
- [no] lsp-mtu (128-4352), 127 configuration command, 127
- [no] match access-list ACL, 175 configuration command, 175
- [no] match as-path WORD, 82 configuration command, 82
- [no] match destinaion-address A.B.C.D/M, 175
- [no] match destinaion-address X:X::X:X/M, 175
- [no] match destination-address A.B.C.D/M configuration command, 175
- [no] match destination-address X:X::X:X/M configuration command, 175
- [no] match dscp (0-63), 175 configuration command, 175
- [no] match protocol (0-63), 176 configuration command, 176
- [no] match source-address A.B.C.D/M, 175 configuration command, 175
- [no] match source-address X:X::X:X/M, 175 configuration command, 175
- [no] minimum-ttl (1-254), 55 configuration command, 55
- [no] monitor session (1-66) source interface INTERFACE [both|rx|tx] configuration command, 208
- [no] mpls ip, 182 configuration command, 182
- [no] mpls ipv6, 182 configuration command, 182
- [no] mpls ldp, 120 configuration command, 120
- [no] neighbor A.B.C.D holdtime HOLDTIME, 120 configuration command, 120
- [no] neighbor A.B.C.D password PASSWORD, 120 configuration command, 120
- [no] neighbor PEER advertisement-interval (0-600), 80 configuration command, 80
- [no] neighbor PEER capability extended-nexthop, 80 configuration command, 80
- [no] neighbor PEER default-originate, 78 configuration command, 78
- [no] neighbor PEER description ..., 78 configuration command, 78
- [no] neighbor PEER disable-connected-check, 78 configuration command, 78
- [no] neighbor PEER dont-capability-negotiate, 81 configuration command, 81
- [no] neighbor PEER ebgp-multihop, 78 configuration command, 78
- [no] neighbor PEER interface IFNAME, 78 configuration command, 78
- [no] neighbor PEER local-as AS-NUMBER [no-prepend] [replace-as], 79 configuration command, 79
- [no] neighbor PEER maximum-prefix NUMBER [force], 79 configuration command, 79

- [no] neighbor PEER maximum-prefix-out NUMBER, 79  
configuration command, 79
- [no] neighbor PEER next-hop-self [all], 78  
configuration command, 78
- [no] neighbor PEER password PASSWORD, 79  
configuration command, 79
- [no] neighbor PEER sender-as-path-loop-detection [no], 81  
configuration command, 81
- [no] neighbor PEER shutdown [message MSG...] [rtt (1-65535) [count (1-255)]], 78  
configuration command, 78
- [no] neighbor PEER ttl-security hops NUMBER, 80  
configuration command, 80
- [no] neighbor PEER update-source <IFNAME|ADDRESS>, 78  
configuration command, 78
- [no] neighbor PEER version VERSION, 78  
configuration command, 78
- [no] neighbor PEER weight WEIGHT, 79  
configuration command, 79
- [no] neighbor X:X::X:X activate, 74  
configuration command, 74
- [no] neighbor <A.B.C.D|X:X::X:X|WORD> addpath-tx-all-paths, 80  
configuration command, 80
- [no] neighbor <A.B.C.D|X:X::X:X|WORD> addpath-tx-bestpath-per-AS, 80  
configuration command, 80
- [no] neighbor <A.B.C.D|X:X::X:X|WORD> allowas-in [<(1-10)|origin>], 79  
configuration command, 79
- [no] neighbor <A.B.C.D|X:X::X:X|WORD> as-override, 79  
configuration command, 79
- [no] network A.B.C.D/M  
configuration command, 42
- [no] ntp-server NTP ...  
configuration command, 43
- [no] ordered-control, 120  
configuration command, 120
- [no] passive-mode, 55  
configuration command, 55
- [no] rewrite tag pop <1|2>, 207  
configuration command, 207
- [no] rewrite tag push <1|2> <dot1q|dot1ad> (0-4095) [(0-4095)], 207  
configuration command, 207
- [no] router isis WORD [vrf NAME], 126  
configuration command, 126
- [no] router-id A.B.C.D, 120  
configuration command, 120
- [no] set as-path prepend AS-PATH, 82  
configuration command, 82
- [no] set as-path prepend last-as NUM, 82  
configuration command, 82
- [no] set distance DISTANCE, 25  
configuration command, 25
- [no] set ikev2 profile IKEPROFILE, 203  
configuration command, 203
- [no] set metric <[+|-](1-4294967295)|rtt|+rtt|-rtt>, 25  
configuration command, 25
- [no] set transform-set IPSECTS, 203  
configuration command, 203
- [no] shutdown, 55  
configuration command, 55
- [no] tunnel vrf VRF  
configuration command, 183

## A

- access-list resequence ACL4 (1-2147483647) (I-32765), 180  
configuration command, 180
- agentx, 33  
configuration command, 33
- aggregate-address A.B.C.D/M, 74  
configuration command, 74
- aggregate-address A.B.C.D/M as-set, 74  
configuration command, 74
- aggregate-address A.B.C.D/M origin <egp|igp|incomplete>, 74  
configuration command, 74
- aggregate-address A.B.C.D/M route-map NAME, 74  
configuration command, 74
- aggregate-address A.B.C.D/M summary-only, 74  
configuration command, 74
- aggregate-address X:X::X:X/M, 75  
configuration command, 75
- aggregate-address X:X::X:X/M as-set, 75  
configuration command, 75
- aggregate-address X:X::X:X/M origin <egp|igp|incomplete>, 75  
configuration command, 75
- aggregate-address X:X::X:X/M route-map NAME, 75  
configuration command, 75
- aggregate-address X:X::X:X/M summary-only, 75  
configuration command, 75
- allowed-ip A.B.C.D/M, 195  
configuration command, 195
- area (0-4294967295) authentication, 144  
configuration command, 144

- area (0-4294967295) authentication message-digest, 144
    - configuration command, 144
  - area (0-4294967295) export-list NAME, 143
    - configuration command, 143
  - area (0-4294967295) filter-list prefix NAME in, 144
    - configuration command, 144
  - area (0-4294967295) filter-list prefix NAME out, 144
    - configuration command, 144
  - area (0-4294967295) import-list NAME, 144
    - configuration command, 144
  - area (0-4294967295) range A.B.C.D/M, 142
    - configuration command, 142
  - area (0-4294967295) shortcut, 143
    - configuration command, 143
  - area (0-4294967295) stub, 143
    - configuration command, 143
  - area (0-4294967295) stub no-summary, 143
    - configuration command, 143
  - area (0-4294967295) virtual-link A.B.C.D, 143
    - configuration command, 143
  - area A.B.C.D authentication, 144
    - configuration command, 144
  - area A.B.C.D authentication message-digest, 144
    - configuration command, 144
  - area A.B.C.D default-cost (0-16777215), 143
    - configuration command, 143
  - area A.B.C.D export-list NAME, 143
    - configuration command, 143
  - area A.B.C.D filter-list prefix NAME in, 144
    - configuration command, 144
  - area A.B.C.D filter-list prefix NAME out, 144
    - configuration command, 144
  - area A.B.C.D import-list NAME, 144
    - configuration command, 144
  - area A.B.C.D range A.B.C.D/M, 142
    - configuration command, 142
  - area A.B.C.D range IPV4\_PREFIX not-advertise, 142
    - configuration command, 142
  - area A.B.C.D range IPV4\_PREFIX substitute IPV4\_PREFIX, 142
    - configuration command, 142
  - area A.B.C.D shortcut, 143
    - configuration command, 143
  - area A.B.C.D stub, 143
    - configuration command, 143
  - area A.B.C.D stub no-summary, 143
    - configuration command, 143
  - area A.B.C.D virtual-link A.B.C.D, 143
    - configuration command, 143
  - area-password [clear | md5] <password>, 126
    - configuration command, 126
  - authentication local pre-share, 202
    - configuration command, 202
  - authentication local rsa-sig, 202
    - configuration command, 202
  - authentication remote pre-share, 202
    - configuration command, 202
  - authentication remote rsa-sig, 202
    - configuration command, 202
  - auto-cost reference-bandwidth (1-4294967), 141
    - configuration command, 141
  - auto-cost reference-bandwidth COST, 153
    - configuration command, 153
- ## B
- banner motd line LINE, 5
    - configuration command, 5
  - bfd, 54
    - configuration command, 54
  - bgp always-compare-med, 70
    - configuration command, 70
  - bgp as-path access-list WORD permit|deny LINE, 82
    - configuration command, 82
  - bgp bestpath as-path confed, 66
    - configuration command, 66
  - bgp bestpath as-path multipath-relax, 66
    - configuration command, 66
  - bgp bestpath bandwidth <ignore | skip-missing | default-weight-for-missing>, 117
    - configuration command, 117
  - bgp bestpath compare-routerid
    - configuration command, 66
  - bgp cluster-id A.B.C.D, 97
    - configuration command, 97
  - bgp community-list (100-199) permit|deny COMMUNITY, 85
    - configuration command, 85
  - bgp community-list (1-99) permit|deny COMMUNITY, 85
    - configuration command, 85
  - bgp community-list expanded NAME permit|deny COMMUNITY, 84
    - configuration command, 84
  - bgp community-list NAME permit|deny COMMUNITY, 84
    - configuration command, 84
  - bgp community-list standard NAME permit|deny COMMUNITY, 84
    - configuration command, 84
  - bgp dampening (1-45) (1-20000) (1-20000) (1-255)

- configuration command, 67
  - bgp deterministic-med, 70
    - configuration command, 70
  - bgp extcommunity-list expanded NAME
    - permit|deny LINE, 88
    - configuration command, 88
  - bgp extcommunity-list standard NAME
    - permit|deny EXTCOMMUNITY, 88
    - configuration command, 88
  - bgp graceful-restart, 73
    - configuration command, 73
  - bgp graceful-restart disable, 73
    - configuration command, 73
  - bgp graceful-restart rib-stale-time (*1-3600*), 72
    - configuration command, 72
  - bgp graceful-restart select-defer-time (*0-3600*), 72
    - configuration command, 72
  - bgp large-community-list expanded NAME
    - permit|deny LINE, 90
    - configuration command, 90
  - bgp large-community-list standard NAME
    - permit|deny LARGE-COMMUNITY, 90
    - configuration command, 90
  - bgp route-reflector allow-outbound-policy, 81
    - configuration command, 81
  - bgp router-id A.B.C.D, 64
    - configuration command, 64
  - bgp update-delay MAX-DELAY ESTABLISH-WAIT, 76
    - configuration command, 76
  - bridge-group (1-65535) split-horizon group (*0-255*), 207
  - bridge-group (1-65535) [split-horizon group (*0-255*)]
    - configuration command, 207
- ## C
- cache timeout active (*1-604800*), 41
    - configuration command, 41
  - cache timeout inactive (*1-604800*), 41
    - configuration command, 41
  - Call Action, 22
  - call NAME, 25
    - configuration command, 25
  - call WORD, 109
    - configuration command, 109
  - capability opaque, 149
    - configuration command, 149
  - class CNAME, 176
    - configuration command, 176
  - class-map match-all CNAME, 175
    - configuration command, 175
  - class-map match-any CNAME, 175
    - configuration command, 175
  - configuration command, 175
    - clear bgp \\*, 94
      - configuration command, 94
    - clear bgp ipv4|ipv6 \\*, 94
      - configuration command, 94
    - clear bgp ipv4|ipv6 PEER, 94
      - configuration command, 94
    - clear bgp ipv4|ipv6 PEER soft|in|out, 94
      - configuration command, 94
    - clear bgp ipv4|ipv6 unicast \\*, 94
      - configuration command, 94
    - clear bgp ipv4|ipv6 unicast PEER, 94
      - configuration command, 94
    - clear bgp ipv4|ipv6 unicast PEER soft|in|out, 94
      - configuration command, 94
    - clear command history [(*0-200*)], 9
      - configuration command, 9
    - clear ip arp, 206
      - configuration command, 206
    - clear ip arp [IFNAME A.B.C.D]
      - configuration command, 206
    - clear ip dhcp binding, 44
      - configuration command, 44
    - clear ip dhcp binding <\*[A.B.C.D]>
      - configuration command, 44
    - clear ip igmp interfaces, 171
      - configuration command, 171
    - clear ip interfaces, 171
      - configuration command, 171
    - clear ip mroute, 171
      - configuration command, 171
    - clear ip mroute [vrf NAME] count, 171
      - configuration command, 171
    - clear ip pim interfaces, 171
      - configuration command, 171
    - clear ip pim oil, 171
      - configuration command, 171
    - clear ip prefix-list [NAME [A.B.C.D/M]], 21
      - configuration command, 21
    - clear line (*0-530*), 5
      - configuration command, 5
    - clear log, 28
      - configuration command, 28
    - clear log [syslog]
      - configuration command, 28
    - clear route-map counter [WORD], 23
      - configuration command, 23
    - clock set TIME (1-12) (1-31) (*2000-4192*), 37
      - configuration command, 37
    - clock timezone TIMEZONE, 8
      - configuration command, 8
    - configuration command
      - (1-4294967295) <deny|permit>
        - PROTOSERVICE <any|A.B.C.D/M>
        - <any|A.B.C.D/M> [exact-match], 179



- (1-4294967295) <deny|permit>  
<any|A.B.C.D/M>, 178
- (1-4294967295) <deny|permit>  
<any|A.B.C.D/M> <any|A.B.C.D/M>  
[exact-match], 178
- (1-4294967295) <deny|permit> icmp  
<any|A.B.C.D/M> <any|A.B.C.D/M>  
ICMP\_TYPE\_CODES [exact-match]", 179
- (1-4294967295) <deny|permit>  
tcp <any|A.B.C.D/M> SRC\_PORT  
<any|A.B.C.D/M> DST\_PORT  
[tcp-flag-mask (0-255)] [TCP FLAGS]  
[exact-match], 179
- (1-4294967295) <deny|permit>  
udp <any|A.B.C.D/M> SRC\_PORT  
<any|A.B.C.D/M> DST\_PORT  
[exact-match], 179
- [no] <ip|ipv6> router isis WORD [vrf  
NAME], 128
- [no] address-family [ipv4 | ipv6], 120
- [no] bgp default ipv4-unicast, 74, 80
- [no] bgp default show-hostname, 80
- [no] bgp default show-next-hop-hostname,  
80
- [no] bgp disable-ebgp-connected-route-check,  
67
- [no] bgp ebgp-requires-policy, 66
- [no] bgp fast-external-failover, 80
- [no] bgp listen range  
<A.B.C.D/M|X:X::X:X/M> peer-group  
PGNAME, 77
- [no] bgp network import-check, 73
- [no] bgp reject-as-sets, 67
- [no] bgp shutdown [message MSG...], 73
- [no] bundle id (1-65535), 209
- [no] coalesce-time (0-4294967295), 77
- [no] crypto ipsec profile IPSECPROFILE,  
203
- [no] debug acl event, 181
- [no] debug bfd network, 61
- [no] debug bfd peer, 61
- [no] debug bfd zebra, 62
- [no] debug bgp bestpath  
<A.B.C.D/M|X:X::X:X/M>, 93
- [no] debug bgp keepalives, 93
- [no] debug bgp neighbor-events, 93
- [no] debug bgp nht, 93
- [no] debug bgp update-groups, 93
- [no] debug bgp updates, 93
- [no] debug bgp zebra, 93
- [no] debug bond event, 210
- [no] debug bridge event, 208
- [no] debug dplane fib, 26
- [no] debug dplane ipsec, 26
- [no] debug ipfix event, 41
- [no] debug ipsec event, 205
- [no] debug ipsec vici detail, 205
- [no] debug ipsec vici json, 205
- [no] debug mpls ldp KIND, 122
- [no] debug nat44 event, 174
- [no] debug qos event, 177
- [no] debug service dhcp4, 26
- [no] debug service mender, 26
- [no] debug service ntpd, 26
- [no] debug service snmp, 26
- [no] debug span event, 208
- [no] debug tunnel event, 184
- [no] debug vlan event, 208
- [no] debug vpls event, 187
- [no] debug vrf event, 182
- [no] debug vxlan event, 186
- [no] default-router A.B.C.D ..., 43
- [no] discovery hello holdtime HOLDTIME,  
120
- [no] discovery hello interval INTERVAL,  
120
- [no] discovery transport-address  
A.B.C.D | A:B::C:D, 120
- [no] dns-server A.B.C.D ..., 43
- [no] domain-name NAME, 43
- [no] dual-stack transport-connection  
prefer ipv4, 120
- [no] echo-mode, 55
- [no] endpoint A.B.C.D port (1000-65535),  
196
- [no] included-address A.B.C.D A.B.C.D, 43
- [no] interface IFACE, 120
- [no] ip dhcp pool DHCP4POOL, 42
- [no] ip dhcp server, 44
- [no] ip host NAME A.B.C.D, 8
- [no] ip igmp watermark-warn (10-60000), 166
- [no] ip msdp mesh-group WORD member  
A.B.C.D, 166
- [no] ip msdp mesh-group WORD source  
A.B.C.D, 166
- [no] ip msdp mesh-group [WORD], 166
- [no] ip name-server A.B.C.D, 8
- [no] ip pim use-source A.B.C.D, 167
- [no] ipv6 nd adv-interval-option, 39
- [no] ipv6 nd dnssl domain-name-suffix  
[lifetime], 39
- [no] ipv6 nd home-agent-config-flag, 39
- [no] ipv6 nd home-agent-lifetime  
[(0-65520)], 39
- [no] ipv6 nd home-agent-preference  
[(0-65535)], 39
- [no] ipv6 nd managed-config-flag, 38
- [no] ipv6 nd mtu [(1-65535)], 39

- [no] ipv6 nd other-config-flag, 38
- [no] ipv6 nd ra-fast-retrans, 38
- [no] ipv6 nd ra-hop-limit [(0-255)], 38
- [no] ipv6 nd ra-interval [(1-1800)], 38
- [no] ipv6 nd ra-interval [msec (70-1800000)], 38
- [no] ipv6 nd ra-lifetime [(0-9000)], 38
- [no] ipv6 nd ra-retrans-interval [(0-4294967295)], 38
- [no] ipv6 nd rdns ipv6address [lifetime], 39
- [no] ipv6 nd reachable-time [(1-3600000)], 38
- [no] ipv6 nd router-preference [(high|medium|low)], 39
- [no] lease <(0-365) (0-23) (0-59)|infinite>, 43
- [no] log commands, 28
- [no] log facility [FACILITY], 28
- [no] log file [LEVEL], 27
- [no] log monitor [LEVEL], 27
- [no] log record-priority, 28
- [no] log rotate max-file-life (1-1000), 27
- [no] log rotate max-retention (1-1000), 27
- [no] log syslog HOST loki [skip-host-verify] [port (100-65535)], 27
- [no] log syslog [A.B.C.D|HOST] tcp [tls [skip-host-verify]] [port (100-65535)], 27
- [no] log syslog [LEVEL], 27
- [no] log timestamp precision [(0-6)], 28
- [no] lsp-mtu (128-4352), 127
- [no] match access-list ACL, 175
- [no] match as-path WORD, 82
- [no] match destination-address A.B.C.D/M, 175
- [no] match destination-address X:X::X/M, 175
- [no] match dscp (0-63), 175
- [no] match protocol (0-63), 176
- [no] match source-address A.B.C.D/M, 175
- [no] match source-address X:X::X/M, 175
- [no] minimum-ttl (1-254), 55
- [no] monitor session (1-66) source interface INTERFACE [both|rx|tx], 208
- [no] mpls ip, 182
- [no] mpls ipv6, 182
- [no] mpls ldp, 120
- [no] neighbor A.B.C.D holdtime HOLDTIME, 120
- [no] neighbor A.B.C.D password PASSWORD, 120
- [no] neighbor PEER advertisement-interval (0-600), 80
- [no] neighbor PEER capability extended-nexthop, 80
- [no] neighbor PEER default-originate, 78
- [no] neighbor PEER description ..., 78
- [no] neighbor PEER disable-connected-check, 78
- [no] neighbor PEER dont-capability-negotiate, 81
- [no] neighbor PEER ebgp-multihop, 78
- [no] neighbor PEER interface IFNAME, 78
- [no] neighbor PEER local-as AS-NUMBER [no-prepend] [replace-as], 79
- [no] neighbor PEER maximum-prefix NUMBER [force], 79
- [no] neighbor PEER maximum-prefix-out NUMBER, 79
- [no] neighbor PEER next-hop-self [all], 78
- [no] neighbor PEER password PASSWORD, 79
- [no] neighbor PEER sender-as-path-loop-detection, 81
- [no] neighbor PEER shutdown [message MSG...] [rtt (1-65535) [count (1-255)]], 78
- [no] neighbor PEER ttl-security hops NUMBER, 80
- [no] neighbor PEER update-source <IFNAME|ADDRESS>, 78
- [no] neighbor PEER version VERSION, 78
- [no] neighbor PEER weight WEIGHT, 79
- [no] neighbor X:X::X:X activate, 74
- [no] neighbor <A.B.C.D|X:X::X:X|WORD> addpath-tx-all-paths, 80
- [no] neighbor <A.B.C.D|X:X::X:X|WORD> addpath-tx-bestpath-per-AS, 80
- [no] neighbor <A.B.C.D|X:X::X:X|WORD> allowas-in [<(1-10)|origin>], 79
- [no] neighbor <A.B.C.D|X:X::X:X|WORD> as-override, 79
- [no] network A.B.C.D/M, 42
- [no] ntp-server NTP ..., 43
- [no] ordered-control, 120
- [no] passive-mode, 55
- [no] rewrite tag pop <1|2>, 207
- [no] rewrite tag push <1|2> <dot1q|dot1ad> (0-4095) [(0-4095)], 207
- [no] router isis WORD [vrf NAME], 126
- [no] router-id A.B.C.D, 120
- [no] set as-path prepend AS-PATH, 82
- [no] set as-path prepend last-as NUM, 82
- [no] set distance DISTANCE, 25

[no] set ikev2 profile IKEPROFILE, 203

[no] set metric <[+|-](1-4294967295)|rtt|+rtt|-rtt substitute IPV4\_PREFIX, 142  
25

[no] set transform-set IPSECTS, 203

[no] shutdown, 55

[no] tunnel vrf VRF, 183

access-list resequence ACL4  
(1-2147483647) (I-32765), 180

agentx, 33

aggregate-address A.B.C.D/M, 74

aggregate-address A.B.C.D/M as-set, 74

aggregate-address A.B.C.D/M origin  
<egp|igp|incomplete>, 74

aggregate-address A.B.C.D/M route-map  
NAME, 74

aggregate-address A.B.C.D/M  
summary-only, 74

aggregate-address X:X::X:X/M, 75

aggregate-address X:X::X:X/M as-set, 75

aggregate-address X:X::X:X/M origin  
<egp|igp|incomplete>, 75

aggregate-address X:X::X:X/M route-map  
NAME, 75

aggregate-address X:X::X:X/M  
summary-only, 75

allowed-ip A.B.C.D/M, 195

area (0-4294967295) authentication, 144

area (0-4294967295) authentication  
message-digest, 144

area (0-4294967295) export-list NAME, 143

area (0-4294967295) filter-list prefix  
NAME in, 144

area (0-4294967295) filter-list prefix  
NAME out, 144

area (0-4294967295) import-list NAME, 144

area (0-4294967295) range A.B.C.D/M, 142

area (0-4294967295) shortcut, 143

area (0-4294967295) stub, 143

area (0-4294967295) stub no-summary, 143

area (0-4294967295) virtual-link  
A.B.C.D, 143

area A.B.C.D authentication, 144

area A.B.C.D authentication  
message-digest, 144

area A.B.C.D default-cost (0-16777215), 143

area A.B.C.D export-list NAME, 143

area A.B.C.D filter-list prefix NAME in,  
144

area A.B.C.D filter-list prefix NAME  
out, 144

area A.B.C.D import-list NAME, 144

area A.B.C.D range A.B.C.D/M, 142

area A.B.C.D range IPV4\_PREFIX  
not-advertise, 142

area A.B.C.D range IPV4\_PREFIX  
substitute IPV4\_PREFIX, 142

area A.B.C.D shortcut, 143

area A.B.C.D stub, 143

area A.B.C.D stub no-summary, 143

area A.B.C.D virtual-link A.B.C.D, 143

area-password [clear | md5] <password>,  
126

authentication local pre-share, 202

authentication local rsa-sig, 202

authentication remote pre-share, 202

authentication remote rsa-sig, 202

auto-cost reference-bandwidth (I-4294967),  
141

auto-cost reference-bandwidth COST, 153

banner motd line LINE, 5

bfd, 54

bgp always-compare-med, 70

bgp as-path access-list WORD  
permit|deny LINE, 82

bgp bestpath as-path confed, 66

bgp bestpath as-path multipath-relax, 66

bgp bestpath bandwidth  
<ignore | skip-missing |  
default-weight-for-missing>, 117

bgp bestpath compare-routerid, 66

bgp cluster-id A.B.C.D, 97

bgp community-list (100-199)  
permit|deny COMMUNITY, 85

bgp community-list (1-99) permit|deny  
COMMUNITY, 85

bgp community-list expanded NAME  
permit|deny COMMUNITY, 84

bgp community-list NAME permit|deny  
COMMUNITY, 84

bgp community-list standard NAME  
permit|deny COMMUNITY, 84

bgp dampening (1-45) (1-20000)  
(1-20000) (I-255), 67

bgp deterministic-med, 70

bgp extcommunity-list expanded NAME  
permit|deny LINE, 88

bgp extcommunity-list standard NAME  
permit|deny EXTCOMMUNITY, 88

bgp graceful-restart, 73

bgp graceful-restart disable, 73

bgp graceful-restart rib-stale-time  
(I-3600), 72

bgp graceful-restart select-defer-time  
(0-3600), 72

bgp large-community-list expanded NAME  
permit|deny LINE, 90

bgp large-community-list standard NAME  
permit|deny LARGE-COMMUNITY, 90

bgp route-reflector  
     allow-outbound-policy, 81  
 bgp router-id A.B.C.D, 64  
 bgp update-delay MAX-DELAY  
     ESTABLISH-WAIT, 76  
 bridge-group (1-65535) [split-horizon  
     group (0-255)], 207  
 cache timeout active (1-604800), 41  
 cache timeout inactive (1-604800), 41  
 call NAME, 25  
 call WORD, 109  
 capability opaque, 149  
 class CNAME, 176  
 class-map match-all CNAME, 175  
 class-map match-any CNAME, 175  
 clear bgp \\*, 94  
 clear bgp ipv4|ipv6 \\*, 94  
 clear bgp ipv4|ipv6 PEER, 94  
 clear bgp ipv4|ipv6 PEER soft|in|out, 94  
 clear bgp ipv4|ipv6 unicast \\*, 94  
 clear bgp ipv4|ipv6 unicast PEER, 94  
 clear bgp ipv4|ipv6 unicast PEER  
     soft|in|out, 94  
 clear command history [(0-200)], 9  
 clear ip arp [IFNAME A.B.C.D], 206  
 clear ip dhcp binding <\*[A.B.C.D]>, 44  
 clear ip igmp interfaces, 171  
 clear ip interfaces, 171  
 clear ip mroute, 171  
 clear ip mroute [vrf NAME] count, 171  
 clear ip pim interfaces, 171  
 clear ip pim oil, 171  
 clear ip prefix-list [NAME [A.B.C.D/M]],  
     21  
 clear line (0-530), 5  
 clear log [syslog], 28  
 clear route-map counter [WORD], 23  
 clock set TIME (1-12) (1-31) (2000-4192),  
     37  
 clock timezone TIMEZONE, 8  
 configure [terminal], 9  
 continue, 25  
 continue N, 25  
 control-plane, 51  
 cpu main [exclusive] (1-256), 50  
 cpu weight (1-10000), 50-52  
 cpu worker [exclusive] (1-256)..., 50  
 cpu [exclusive] (1-256)..., 51, 52  
 crypto ikev2 dpd (1-3600), 200  
 crypto ikev2 keyring IKEKEYRING, 201  
 crypto ikev2 proposal IKEPOSAL, 200  
 crypto ipsec transform-set IPSECTS esp  
     {hmac HMAC\_ALG |cipher CIPHER\_ALG},  
     203  
 crypto ipsec transform-set IPSECTS ah  
     hmac HMAC\_ALG, 203  
 crypto key generate rawraw label LABEL  
     bytes (32-1024), 188  
 crypto key generate rsa label NAME  
     modulus (2048|4096), 188  
 crypto key generate ssh modulus  
     (2048|4096), 188  
 crypto key generate x25519 label LABEL,  
     188  
 crypto key zeroize RSAKEY, 193  
 crypto pki authenticate TP, 188  
 crypto pki enroll TP, 189  
 crypto pki import TP certificate, 190  
 crypto pki trustpoint NAME, 188  
 data-plane, 49  
 debug eigrp packets, 125  
 debug eigrp transmit, 125  
 debug igmp, 171  
 debug isis adj-packets, 130  
 debug isis checksum-errors, 130  
 debug isis events, 130  
 debug isis local-updates, 130  
 debug isis packet-dump, 130  
 debug isis protocol-errors, 130  
 debug isis route-events, 130  
 debug isis snp-packets, 130  
 debug isis spf-events, 131  
 debug isis spf-statistics, 131  
 debug isis spf-triggers, 131  
 debug isis update-packets, 131  
 debug mroute, 171  
 debug mtrace, 171  
 debug ospf event, 150  
 debug ospf ism, 150  
 debug ospf ism (status|events|timers), 150  
 debug ospf lsa, 150  
 debug ospf lsa (generate|flooding|refresh), 150  
 debug ospf nsm, 150  
 debug ospf nsm (status|events|timers), 150  
 debug ospf nssa, 150  
 debug ospf packet  
     (hello|dd|ls-request|ls-update|ls-ack|all)  
     (send|recv) [detail], 150  
 debug ospf zebra, 150  
 debug ospf zebra (interface|redistribute), 151  
 debug pim bsm, 171  
 debug pim events, 171  
 debug pim nht, 171  
 debug pim packet-dump, 171  
 debug pim packets, 171  
 debug pim trace, 171  
 debug pim zebra, 171  
 debug rip events, 162

debug rip packet, 162  
 debug rip zebra, 162  
 debug ripng events, 163  
 debug ripng packet, 163  
 debug ripng zebra, 163  
 default-information originate, 147, 158  
 default-information originate always, 147  
 default-information originate always metric (0-16777214), 147  
 default-information originate always metric (0-16777214) metric-type (1|2), 147  
 default-information originate always metric (0-16777214) metric-type (1|2) route-map WORD, 147  
 default-information originate metric (0-16777214), 147  
 default-information originate metric (0-16777214) metric-type (1|2), 147  
 default-information originate metric (0-16777214) metric-type (1|2) route-map WORD, 147  
 default-metric (0-16777214), 148  
 default-metric (1-16), 159  
 destination A.B.C.D, 40  
 detect-multiplier (2-255), 54  
 distance (1-255), 148, 159  
 distance (1-255) A.B.C.D/M, 66, 159  
 distance (1-255) A.B.C.D/M ACCESS-LIST, 159  
 distance (1-255) A.B.C.D/M WORD, 66  
 distance bgp (1-255) (1-255) (1-255), 66  
 distance ospf (intra-area|inter-area|external) (1-255), 148  
 distribute-list ACCESS\_LIST (in|out) IFNAME, 163  
 distribute-list ACCESS\_LIST DIRECT IFNAME, 158  
 distribute-list NAME out (kernel|connected|static|rip|ospf), 148  
 distribute-list prefix PREFIX\_LIST (in|out) IFNAME, 158  
 domain-password [clear | md5] <password>, 126  
 dump bgp all PATH [INTERVAL], 93  
 dump bgp all-et PATH [INTERVAL], 93  
 dump bgp routes-mrt PATH, 93  
 dump bgp routes-mrt PATH INTERVAL, 93  
 dump bgp updates PATH [INTERVAL], 93  
 dump bgp updates-et PATH [INTERVAL], 93  
 echo-interval (10-60000), 55  
 enable config password PASSWORD, 4  
 enable password PASSWORD, 3  
 encapsulation default, 206  
 encapsulation dot1ad (1-4094) dot1q (1-4094), 206  
 encapsulation dot1q (1-4094) [exact] [second-dot1q (1-4094)], 206  
 encryption ALGORITHM, 200  
 enrollment terminal pem, 189  
 find COMMAND..., 17  
 flow exporter, 40  
 flow monitor, 41  
 flush\_timer TIME, 163  
 group GROUP, 200  
 hostname dynamic, 126  
 hostname HOSTNAME, 7  
 identity address <A.B.C.D|X:X::X:X>, 201  
 identity email MAIL, 201  
 identity fqdn FQDN, 201  
 identity local address <A.B.C.D|X:X::X:X>, 201  
 identity local email MAIL, 201  
 identity local fqdn FQDN, 201  
 import vrf VRFNAME, 92  
 import|export vpn, 92  
 ingress-replication A.B.C.D, 185  
 integrity ALGORITHM, 200  
 interface bundle-ether (1-65535), 209  
 interface IFNAME area (0-4294967295), 152  
 interface IFNAME area A.B.C.D, 152  
 interface IFNAME. (0-4095), 206  
 interface mpls-tunnel, 186  
 interface nve (0-1023), 185  
 interface tunnel [vrf VRF] (0-1023), 183  
 interface wireguard (0-1023), 195  
 ip access-group ACL4 in, 180  
 ip access-group ACL4 in out, 180  
 ip access-group ACL4 out, 180  
 ip access-list ACL4, 178  
 ip flow monitor output, 41  
 ip igmp, 167  
 ip igmp generate-query-once [version (2-3)], 166  
 ip igmp join A.B.C.D [A.B.C.D], 167  
 ip igmp last-member-query-count (1-7), 168  
 ip igmp last-member-query-interval (1-255), 168  
 ip igmp query-interval (1-1800), 167  
 ip igmp query-max-response-time (10-250), 167  
 ip igmp version (2-3), 167  
 ip mroute A.B.C.D/M A.B.C.D (1-255), 168  
 ip mroute A.B.C.D/M INTERFACE (1-255), 168  
 ip mroute INTERFACE A.B.C.D [A.B.C.D], 168  
 ip multicast boundary oil WORD, 168

```

ip multicast rpf-lookup-mode WORD, 166
ip nat inside, 174
ip nat inside source static <tcp|udp>
  A.B.C.D (1-65535) A.B.C.D (1-65535),
  173
ip nat inside source static A.B.C.D
  A.B.C.D, 172
ip nat outside, 174
ip nat pool PNAT44 A.B.C.D [ A.B.C.D ],
  174
ip ospf area (A.B.C.D|(0-4294967295)),
  146
ip ospf area AREA [ADDR], 145
ip ospf authentication message-digest,
  145
ip ospf authentication-key AUTH_KEY, 145
ip ospf bfd, 57
ip ospf cost (1-65535), 145
ip ospf dead-interval (1-65535), 145
ip ospf dead-interval minimal
  hello-multiplier (2-20), 145
ip ospf hello-interval (1-65535), 146
ip ospf message-digest-key KEYID md5
  KEY, 145
ip ospf network (broadcast|non-
  broadcast|point-to-multipoint|point-to-point),
  146
ip ospf priority (0-255), 146
ip ospf retransmit-interval (1-65535), 146
ip ospf transmit-delay (1-65535)
  [A.B.C.D], 146
ip pim, 167
ip pim active-active, 167
ip pim bfd, 167
ip pim bsm, 167
ip pim drpriority (1-4294967295), 167
ip pim ecmp, 165
ip pim ecmp rebalance, 165
ip pim hello (1-180) (1-180), 167
ip pim join-prune-interval (60-600), 165
ip pim keep-alive-timer (31-60000), 166
ip pim packets (1-100), 166
ip pim register-accept-list PLIST, 165
ip pim register-suppress-time (5-60000),
  166
ip pim rp A.B.C.D A.B.C.D/M, 165
ip pim send-v6-secondary, 166
ip pim spt-switchover
  infinity-and-beyond, 165
ip pim ssm prefix-list WORD, 166
ip pim unicast-bsm, 167
ip prefix-list NAME (permit|deny)
  PREFIX [le LEN] [ge LEN], 20
ip prefix-list NAME description DESC, 21
ip prefix-list NAME seq NUMBER
  (permit|deny) PREFIX [le LEN] [ge
  LEN], 20
ip prefix-list sequence-number, 21
ip rip authentication key-chain
  KEY-CHAIN, 161
ip rip authentication mode md5, 160
ip rip authentication mode text, 160
ip rip authentication string STRING, 160
ip rip receive version VERSION, 157
ip rip send version VERSION, 157
ip route NETWORK GATEWAY table TABLENO
  nexthop-vrf VRFNAME DISTANCE vrf
  VRFNAME, 164
ip split-horizon, 156
ip ssh client, 7
ip ssh pubkey-chain, 6
ip verify unicast source reachable-via
  [rx | any], 33
ip vrf forwarding NAME, 181
ipv6 access-group ACL6 in, 180
ipv6 access-group ACL6 in out, 180
ipv6 access-group ACL6 out, 180
ipv6 enable, 37
ipv6 nd prefix ipv6prefix
  [valid-lifetime]
  [preferred-lifetime] [off-link]
  [no-autoconfig] [router-address], 37
ipv6 nd suppress-ra, 37
ipv6 ospf6 bfd, 57
ipv6 ospf6 cost COST, 153
ipv6 ospf6 dead-interval DEADINTERVAL,
  153
ipv6 ospf6 hello-interval HELLOINTERVAL,
  153
ipv6 ospf6 network (broadcast|point-to-point),
  154
ipv6 ospf6 priority PRIORITY, 153
ipv6 ospf6 retransmit-interval
  RETRANSMITINTERVAL, 153
ipv6 ospf6 transmit-delay TRANSMITDELAY,
  154
ipv6 route NETWORK from SRCPREFIX
  GATEWAY table TABLENO nexthop-vrf
  VRFNAME DISTANCE vrf VRFNAME, 164
is-type [level-1 | level-1-2 |
  level-2-only], 127
isis bfd, 56
isis bfd profile BFDPROF, 56
isis circuit-type [level-1 | level-1-2
  | level-2], 128
isis csnp-interval (1-600), 128
isis csnp-interval (1-600) [level-1 |
  level-2], 128

```

isis hello padding, 128  
 isis hello-interval (1-600), 128  
 isis hello-interval (1-600) [level-1 | level-2], 128  
 isis hello-multiplier (2-100), 128  
 isis hello-multiplier (2-100) [level-1 | level-2], 128  
 isis metric [(0-255) | (0-16777215)], 128  
 isis metric [(0-255) | (0-16777215)] [level-1 | level-2], 128  
 isis network point-to-point, 128  
 isis passive, 129  
 isis password [clear | md5] <password>, 129  
 isis priority (0-127), 129  
 isis priority (0-127) [level-1 | level-2], 129  
 isis psnp-interval (1-120), 129  
 isis psnp-interval (1-120) [level-1 | level-2], 129  
 isis three-way-handshake, 129  
 key LINE ..., 6  
 keyring local IKEKEYRING, 202  
 known-host <A.B.C.D|X:X::X:X|HOST>, 7  
 l2vpn NAME type vpls, 186  
 label vpn export (0..1048575)|auto, 92  
 label WORD, 55  
 license check, 45  
 license generate license-request [terminal], 45  
 lifetime <120-86400>, 202  
 list, 9  
 log export removable-storage, 7  
 log export ssh HOST USER PATH, 7  
 log rotate max-file-size SIZE, 26  
 log rotate max-files (1-1000), 26  
 log rotate max-use SIZE, 26  
 log-adjacency-changes, 126  
 log-adjacency-changes [detail], 140  
 login block-for TIME attempts ATTEMPT within PERIOD, 5  
 login unblock <A.B.C.D|X:X::X:X|all>, 5  
 lsp-gen-interval (1-120), 127  
 lsp-gen-interval [level-1 | level-2] (1-120), 127  
 lsp-refresh-interval [level-1 | level-2] (1-65235), 127  
 management-plane, 52  
 match address local A.B.C.D, 201  
 match any, 175  
 match as-path AS\_PATH, 23  
 match certificate, 202  
 match community COMMUNITY\_LIST, 24  
 match community WORD exact-match [exact-match], 85  
 match extcommunity WORD, 89  
 match identity remote address <A.B.C.D|X:X::X:X>, 202  
 match identity remote email EMAIL, 202  
 match identity remote fqdn FQDN, 202  
 match interface WORD, 159  
 match ip address ACCESS\_LIST, 23  
 match ip address prefix-len 0-32, 23  
 match ip address prefix-list PREFIX\_LIST, 23  
 match ip address prefix-list WORD, 160  
 match ip address WORD, 160  
 match ip next-hop address IPV4\_ADDR, 23  
 match ip next-hop prefix-list WORD, 160  
 match ip next-hop WORD, 160  
 match ipv6 address ACCESS\_LIST, 23  
 match ipv6 address prefix-len 0-128, 23  
 match ipv6 address prefix-list PREFIX\_LIST, 23  
 match ipv6 next-hop IPV6\_ADDR, 23  
 match large-community LINE [exact-match], 90  
 match local-preference METRIC, 23  
 match metric (0-4294967295), 160  
 match metric METRIC, 23  
 match peer A.B.C.D|X:X::X:X, 109  
 match peer INTERFACE\_NAME, 24  
 match peer IPV4\_ADDR, 24  
 match peer IPV6\_ADDR, 24  
 match source-instance NUMBER, 24  
 match source-protocol PROTOCOL\_NAME, 24  
 match tag TAG, 23  
 max-lsp-lifetime (360-65535), 127  
 max-lsp-lifetime [level-1 | level-2] (360-65535), 127  
 max-metric router-lsa administrative, 141  
 max-metric router-lsa [on-startup|on-shutdown] (5-86400), 141  
 member pseudowire PW, 186  
 member vni (1-16777214), 185  
 member vni (1-16777214) associate-vrf, 185  
 memory heap main SIZE, 50  
 memory heap stats SIZE, 50  
 memory max SIZE, 50, 52, 53  
 memory packet-buffer count (16384-1049776), 51  
 memory packet-buffer size (2048-65536), 51  
 metric-style [narrow | transition | wide], 126  
 mode transport, 203

monitor session (1-66) destination  
     interface INTERFACE, 208  
 mtrace A.B.C.D [A.B.C.D], 170  
 neighbor A.B.C.D|X.X::X.X|peer-group  
     route-map WORD import|export, 109  
 neighbor <A.B.C.D|X.X::X.X|WORD> bfd, 56  
 neighbor <A.B.C.D|X.X::X.X|WORD> bfd  
     check-control-plane-failure, 56  
 neighbor <A.B.C.D|X.X::X.X|WORD> bfd  
     profile BFDPROF, 56  
 neighbor A.B.C.D, 156  
 neighbor A.B.C.D graceful-restart, 73  
 neighbor A.B.C.D  
     graceful-restart-disable, 73  
 neighbor A.B.C.D  
     graceful-restart-helper, 73  
 neighbor A.B.C.D route-server-client, 109  
 neighbor lsr-id A.B.C.D, 186  
 neighbor PEER attribute-unchanged  
     [*{as-path|next-hop|med}*], 78  
 neighbor PEER distribute-list NAME  
     [in|out], 81  
 neighbor PEER filter-list NAME [in|out],  
     81  
 neighbor PEER override-capability, 82  
 neighbor PEER peer-group PGNAME, 81  
 neighbor PEER port PORT, 79  
 neighbor PEER prefix-list NAME [in|out],  
     81  
 neighbor PEER remote-as ASN, 77  
 neighbor PEER remote-as external, 77  
 neighbor PEER remote-as internal, 77  
 neighbor PEER route-map NAME [in|out], 81  
 neighbor PEER route-reflector-client, 97  
 neighbor PEER send-community, 79  
 neighbor PEER solo, 81  
 neighbor PEER strict-capability-match, 81  
 neighbor PEER-GROUP route-server-client,  
     109  
 neighbor WORD peer-group, 81  
 neighbor X.X::X.X route-server-client,  
     109  
 net XX.XXXX. . . .XXX.XX, 126  
 network A.B.C.D/M, 73  
 network A.B.C.D/M area (0-4294967295), 141  
 network A.B.C.D/M area A.B.C.D, 141  
 network IFNAME, 155, 163  
 network NETWORK, 123, 155, 163  
 nexthop vpn export A.B.C.D|X.X::X.X, 92  
 no agentx, 33  
 no aggregate-address A.B.C.D/M, 74  
 no aggregate-address X.X::X.X/M, 75  
 no allowed-ip [A.B.C.D/M], 195  
 no area (0-4294967295) authentication,  
     144  
 no area (0-4294967295) export-list NAME,  
     144  
 no area (0-4294967295) filter-list  
     prefix NAME in, 144  
 no area (0-4294967295) filter-list  
     prefix NAME out, 144  
 no area (0-4294967295) import-list NAME,  
     144  
 no area (0-4294967295) range A.B.C.D/M,  
     142  
 no area (0-4294967295) shortcut, 143  
 no area (0-4294967295) stub, 143  
 no area (0-4294967295) stub no-summary,  
     143  
 no area (0-4294967295) virtual-link  
     A.B.C.D, 143  
 no area A.B.C.D authentication, 144  
 no area A.B.C.D default-cost (0-16777215),  
     143  
 no area A.B.C.D export-list NAME, 143  
 no area A.B.C.D filter-list prefix NAME  
     in, 144  
 no area A.B.C.D filter-list prefix NAME  
     out, 144  
 no area A.B.C.D import-list NAME, 144  
 no area A.B.C.D range A.B.C.D/M, 142  
 no area A.B.C.D range IPV4\_PREFIX  
     not-advertise, 142  
 no area A.B.C.D range IPV4\_PREFIX  
     substitute IPV4\_PREFIX, 142  
 no area A.B.C.D shortcut, 143  
 no area A.B.C.D stub, 143  
 no area A.B.C.D stub no-summary, 143  
 no area A.B.C.D virtual-link A.B.C.D, 143  
 no area-password, 126  
 no auto-cost reference-bandwidth, 141, 153  
 no banner motd, 5  
 no bgp as-path access-list WORD, 82  
 no bgp as-path access-list WORD  
     permit|deny LINE, 82  
 no bgp community-list  
     [standard|expanded] NAME, 85  
 no bgp extcommunity-list expanded NAME,  
     88  
 no bgp extcommunity-list NAME, 88  
 no bgp extcommunity-list standard NAME,  
     88  
 no bgp large-community-list expanded  
     NAME, 90  
 no bgp large-community-list NAME, 90  
 no bgp large-community-list standard  
     NAME, 90



no capability opaque, 149  
no class CNAME, 176  
no class-map CNAM, 175  
no cpu main [[exclusive] (1-256)], 50  
no cpu weight [(1-10000)], 50–52  
no cpu worker [[exclusive] (1-256)], 50–52  
no crypto pki trustpoint TPNAME, 193  
no debug isis adj-packets, 130  
no debug isis checksum-errors, 130  
no debug isis events, 130  
no debug isis local-updates, 130  
no debug isis packet-dump, 130  
no debug isis protocol-errors, 130  
no debug isis route-events, 130  
no debug isis snp-packets, 131  
no debug isis spf-events, 131  
no debug isis spf-statistics, 131  
no debug isis spf-triggers, 131  
no debug isis update-packets, 131  
no debug ospf event, 150  
no debug ospf ism, 150  
no debug ospf ism (status|events|timers), 150  
no debug ospf lsa, 150  
no debug ospf lsa (generate|flooding|refresh), 150  
no debug ospf nsm, 150  
no debug ospf nsm (status|events|timers), 150  
no debug ospf nssa, 150  
no debug ospf packet (hello|dd|ls-request|ls-update|ls-ack|all) (send|recv) [detail], 150  
no debug ospf zebra, 151  
no debug ospf zebra (interface|redistribute), 151  
no default-information originate, 147  
no default-metric, 148  
no default-metric (I-16), 159  
no distance (I-255), 148, 159  
no distance (1-255) A.B.C.D/M, 159  
no distance (1-255) A.B.C.D/M ACCESS-LIST, 159  
no distance ospf, 148  
no distribute-list NAME out (kernel|connected|static|rip|ospf), 148  
no domain-password, 126  
no dump bgp all [PATH] [INTERVAL], 93  
no dump bgp route-mrt [PATH] [INTERVAL], 94  
no dump bgp updates [PATH] [INTERVAL], 93  
no enable config password PASSWORD, 4  
no enable password PASSWORD, 3  
no hostname dynamic, 126  
no import vrf VRFNAME, 92  
no import|export vpn, 92  
no interface tunnel, 183  
no ip access-group ACL4 in, 180  
no ip access-group ACL4 in out, 180  
no ip access-group ACL4 out, 180  
no ip access-list ACL4, 178  
no ip flow monitor output, 41  
no ip ospf area, 146  
no ip ospf area [ADDR], 145  
no ip ospf authentication-key, 145  
no ip ospf bfd, 57  
no ip ospf cost, 145  
no ip ospf dead-interval, 146  
no ip ospf hello-interval, 146  
no ip ospf message-digest-key, 145  
no ip ospf network, 146  
no ip ospf priority, 146  
no ip ospf retransmit interval, 146  
no ip ospf transmit-delay [(1-65535)] [A.B.C.D], 146  
no ip prefix-list NAME, 20  
no ip prefix-list NAME description [DESC], 21  
no ip prefix-list sequence-number, 21  
no ip rip authentication key-chain KEY-CHAIN, 161  
no ip rip authentication mode md5, 160  
no ip rip authentication mode text, 160  
no ip rip authentication string STRING, 161  
no ip split-horizon, 156  
no ip vrf forwarding [NAME], 181  
no ipv6 access-group ACL6 in, 180  
no ipv6 access-group ACL6 in out, 180  
no ipv6 access-group ACL6 out, 180  
no ipv6 nd suppress-ra, 37  
no ipv6 ospf6 bfd, 57  
no is-type, 127  
no isis bfd, 56  
no isis bfd profile BFDPROF, 56  
no isis circuit-type, 128  
no isis csnp-interval, 128  
no isis csnp-interval [level-1 | level-2], 128  
no isis hello-interval, 128  
no isis hello-interval [level-1 | level-2], 128  
no isis hello-multiplier, 128  
no isis hello-multiplier [level-1 | level-2], 128  
no isis metric, 128  
no isis metric [level-1 | level-2], 128  
no isis network point-to-point, 128

no isis passive, 129  
no isis password, 129  
no isis priority, 129  
no isis priority [level-1 | level-2], 129  
no isis psnp-interval, 129  
no isis psnp-interval [level-1 | level-2], 129  
no isis three-way-handshake, 129  
no key (I-65535), 6  
no key HASH, 6  
no known-host <A.B.C.D|X:X::X:X|HOST>, 7  
no label vpn export [(0..1048575)|auto], 92  
no log-adjacency-changes, 126  
no log-adjacency-changes [detail], 140  
no lsp-gen-interval, 127  
no lsp-gen-interval [level-1 | level-2], 127  
no lsp-refresh-interval [level-1 | level-2], 127  
no match any, 175  
no max-lsp-lifetime, 127  
no max-lsp-lifetime [level-1 | level-2], 127  
no max-metric router-lsa [on-startup|on-shutdown|administrative], 141  
no memory heap main [SIZE], 50  
no memory heap stats [SIZE], 50  
no memory max [SIZE], 50, 52, 53  
no memory packet-buffer count [(16384-1049776)], 51  
no memory packet-buffer size [(2048-65536)], 51  
no metric-style, 126  
no neighbor <A.B.C.D|X:X::X:X|WORD> bfd, 56  
no neighbor <A.B.C.D|X:X::X:X|WORD> bfd check-control-plane-failure, 56  
no neighbor <A.B.C.D|X:X::X:X|WORD> bfd profile BFDPROF, 56  
no neighbor A.B.C.D, 156  
no neighbor PEER override-capability, 82  
no neighbor PEER route-reflector-client, 97  
no neighbor PEER strict-capability-match, 81  
no net XX.XXXX. ... .XXX.XX, 126  
no network A.B.C.D/M, 73  
no network A.B.C.D/M area (0-4294967295), 141  
no network A.B.C.D/M area A.B.C.D, 141  
no network IFNAME, 155  
no network NETWORK, 123, 155  
no nexthop vpn export [A.B.C.D|X:X::X:X], 92  
no ntp, 37  
no ntp authentication, 35  
no ntp authentication-key (I-65535), 35  
no ntp server SERVER [OPTIONS], 34  
no ospf abr-type TYPE, 139  
no ospf opaque-lsa, 149  
no ospf rfc1583compatibility, 140  
no ospf router-id [A.B.C.D], 139  
no passive-interface IFNAME, 124, 156  
no passive-interface INTERFACE, 140  
no pce address, 149  
no pce domain as (0-65535), 149  
no pce flag, 149  
no pce neighbor as (0-65535), 149  
no pce scope, 149  
no peer <A.B.C.D|X:X::X:X>\$peer [{multihop|local-address <A.B.C.D|X:X::X:X>\$local|interface IFNAME\$ifname|vrf NAME\$vrf\_name}], 54  
no police, 176  
no policy-map NAME, 176  
no poll sleep [(0-10000)], 51  
no proactive-arp, 142  
no profile WORD, 54  
no purge-originator, 126  
no rd vpn export [AS:NN|IP:nn], 91  
no record netflow <ipv4|ipv6> prefix-port, 41  
no redistribute (kernel|connected|static|rip|bgp), 147  
no redistribute bgp, 124, 158  
no redistribute connected, 124, 157  
no redistribute kernel, 124, 157  
no redistribute ospf, 124, 157  
no redistribute static, 124, 157  
no route A.B.C.D/M, 158  
no route-map optimization, 26  
no route-map vpn import|export [MAP], 92  
no router bgp ASN, 64  
no router eigrp (1-65535) [vrf NAME], 123  
no router ospf [(1-65535)] vrf NAME, 139  
no router rip, 155  
no router zebra, 148  
no router-info, 149  
no rt vpn import|export|both [RTLIST...], 92  
no security passwords min-length, 4  
no set-overload-bit, 126  
no spf-interval, 127  
no spf-interval [level-1 | level-2], 127  
no subject-alt-name LINE, 189  
no system tune profile TPROF, 49

no system update enable, 29  
no timers basic, 161  
no timers throttle spf, 140, 153  
no version, 156  
ntp authentication, 35  
ntp authentication-key (1-65535) sha1  
WORD, 35  
ntp server SERVER [OPTIONS], 34  
offset-list ACCESS-LIST (in|out), 159  
offset-list ACCESS-LIST (in|out) IFNAME,  
159  
on-match goto N, 25  
on-match next, 25  
ospf abr-type TYPE, 139  
ospf opaque-lsa, 149  
ospf rfc1583compatibility, 140  
ospf router-id A.B.C.D, 139  
ospf6 router-id A.B.C.D, 152  
passive-interface (IFNAME|default), 123, 156  
passive-interface INTERFACE, 140  
password, 3  
pce address <A.B.C.D>, 149  
pce domain as (0-65535), 149  
pce flag BITPATTERN, 149  
pce neighbor as (0-65535), 149  
pce scope BITPATTERN, 149  
peer <A.B.C.D|X:X::X:X>  
[*{*multihop|local-address  
<A.B.C.D|X:X::X:X>|interface  
IFNAME|vrf NAME}], 54  
peer PEER, 201  
police BPS [NORMALBURST [MAXBURST]]  
conform-action ACTION exceed-action  
ACTION [*violate-action* ACTION], 176  
policy-map NAME, 176  
poll sleep (0-10000), 51  
pre-shared-key LINE, 201  
proactive-arp, 142  
profile BFDPROF, 55  
profile WORD, 54  
proposal IKEPOSAL, 202  
public-key LINE [base64], 195  
purge-originator, 126  
pw-id (1-4294967295), 186  
rd vpn export AS:NN|IP:nn, 91  
read-quanta (1-10), 94  
receive-interval (10-60000), 54  
record netflow <ipv4|ipv6> prefix-port,  
41  
redistribute (*kernel|connected|static|rip|bgp*),  
147  
redistribute (*kernel|connected|static|rip|bgp*)  
metric (0-16777214), 147  
redistribute (*kernel|connected|static|rip|bgp*)  
metric (0-16777214) route-map WORD,  
147  
redistribute (*kernel|connected|static|rip|bgp*)  
metric-type (1|2), 147  
redistribute (*kernel|connected|static|rip|bgp*)  
metric-type (1|2) metric (0-16777214),  
147  
redistribute (*kernel|connected|static|rip|bgp*)  
metric-type (1|2) metric  
(0-16777214) route-map WORD, 147  
redistribute (*kernel|connected|static|rip|bgp*)  
metric-type (1|2) route-map WORD, 147  
redistribute (*kernel|connected|static|rip|bgp*)  
ROUTE-MAP, 147  
redistribute bgp, 124, 158  
redistribute bgp metric (0-16), 158  
redistribute bgp metric (1-4294967295)  
(0-4294967295) (0-255) (1-255) (1-  
65535), 124  
redistribute bgp route-map ROUTE-MAP, 158  
redistribute connected, 75, 124, 154, 157  
redistribute connected metric (0-16), 157  
redistribute connected metric  
(1-4294967295) (0-4294967295)  
(0-255) (1-255) (1-65535), 124  
redistribute connected route-map  
ROUTE-MAP, 157  
redistribute kernel, 75, 124, 157  
redistribute kernel metric (0-16), 157  
redistribute kernel metric  
(1-4294967295) (0-4294967295)  
(0-255) (1-255) (1-65535), 124  
redistribute kernel route-map ROUTE-MAP,  
157  
redistribute ospf, 76, 124, 157  
redistribute ospf metric (0-16), 157  
redistribute ospf metric (1-4294967295)  
(0-4294967295) (0-255) (1-255) (1-  
65535), 124  
redistribute ospf route-map ROUTE-MAP,  
157  
redistribute rip, 75  
redistribute ripng, 154  
redistribute static, 75, 124, 154, 157  
redistribute static metric (0-16), 157  
redistribute static metric  
(1-4294967295) (0-4294967295)  
(0-255) (1-255) (1-65535), 124  
redistribute static route-map ROUTE-MAP,  
157  
redistribute vnc, 76  
remark LINE ..., 178  
route A.B.C.D/M, 158  
route NETWORK, 163

route-map optimization, 26  
 route-map ROUTE-MAP-NAME (permit|deny)  
     ORDER, 23  
 route-map vpn import|export MAP, 92  
 router bgp AS-NUMBER view NAME, 65  
 router bgp ASN, 64  
 router bgp ASN vrf VRFNAME, 64  
 router eigrp (1-65535) [vrf NAME], 123  
 router ospf [(1-65535)] vrf NAME, 139  
 router ospf6, 152  
 router rip, 155  
 router ripng, 163  
 router zebra, 148, 163  
 router-info [as | area], 149  
 rsakeypair KEY, 189  
 rt vpn import|export|both RTLIST..., 91  
 security passwords min-length, 4  
 service password-encryption, 8  
 service-policy PMAP in, 177  
 set as-path prepend AS\_PATH, 25  
 set comm-list WORD delete, 86  
 set community <none|COMMUNITY> additive,  
     85  
 set community COMMUNITY, 25  
 set extcommunity bandwidth <(1-25600)  
     | cumulative | num-multipaths>  
     [non-transitive], 89  
 set extcommunity rt EXTCOMMUNITY, 89  
 set extcommunity soo EXTCOMMUNITY, 89  
 set ip next-hop A.B.C.D, 160  
 set ip next-hop IPV4\_ADDRESS, 24  
 set ip next-hop peer-address, 24  
 set ip next-hop unchanged, 24  
 set ipv6 next-hop global IPV6\_ADDRESS, 24  
 set ipv6 next-hop local IPV6\_ADDRESS, 25  
 set ipv6 next-hop peer-address, 24  
 set ipv6 next-hop prefer-global, 24  
 set large-community LARGE-COMMUNITY, 90  
 set large-community LARGE-COMMUNITY  
     additive, 90  
 set large-community LARGE-COMMUNITY  
     LARGE-COMMUNITY, 90  
 set local-preference +LOCAL\_PREF, 24  
 set local-preference -LOCAL\_PREF, 25  
 set local-preference LOCAL\_PREF, 24  
 set metric (0-4294967295), 160  
 set metric [+|-] (0-4294967295), 147, 154  
 set mode <rr|xor|active-backup|broadcast|lacp>  
     <12|123|134>, 209  
 set origin ORIGIN <egp|igp|incomplete>,  
     25  
 set security-association lifetime  
     second (120-28800), 203  
 set tag TAG, 24  
 set weight WEIGHT, 25  
 set-overload-bit, 126  
 show bfd [vrf NAME\$vrf\_name] peer  
     <WORD\$label|<A.B.C.D|X:X::X:X>\$peer  
     [{\$multihop|local-address  
     <A.B.C.D|X:X::X:X>\$local|interface  
     IFNAME\$ifname}]> [json], 54  
 show bfd [vrf NAME] peers brief [json],  
     54  
 show bfd [vrf NAME] peers [json], 54  
 show bgp <afi> <safi> neighbors WORD  
     bestpath-routes [json] [wide], 80  
 show bgp <ipv4|ipv6>  
     <unicast|multicast|vpn|labeled-unicast>,  
     95  
 show bgp community-list [NAME detail], 85  
 show bgp extcommunity-list, 89  
 show bgp extcommunity-list NAME detail,  
     89  
 show bgp ipv4 vpn summary, 97  
 show bgp ipv4|ipv6 regexp LINE, 97  
 show bgp ipv6 vpn summary, 97  
 show bgp large-community-list, 90  
 show bgp large-community-list NAME  
     detail, 90  
 show bgp listeners, 93  
 show bgp statistics-all, 96  
 show bgp update-groups statistics, 97  
 show bgp update-groups  
     [advertise-queue|advertised-routes|packet-queue],  
     97  
 show bgp X:X::X:X [wide], 95  
 show bgp [afi] [safi], 95  
 show bgp [afi] [safi] dampening  
     dampened-paths, 95  
 show bgp [afi] [safi] dampening  
     flap-statistics, 95  
 show bgp [afi] [safi] neighbor [PEER], 95  
 show bgp [afi] [safi] statistics, 95  
 show bgp [afi] [safi] summary, 95  
 show bgp [afi] [safi] summary  
     established [json], 95  
 show bgp [afi] [safi] summary failed  
     [json], 95  
 show bgp [wide], 94  
 show bridge (1-65535), 207  
 show clock [json], 8  
 show command history, 9  
 show crypto key [[KEY] [json]] [ssh], 194  
 show crypto pki certificate [CA], 193  
 show daemons status, 8  
 show debug, 93  
 show debugging eigrp, 125  
 show debugging isis, 131

show debugging ospf, 151  
 show debugging rip, 162  
 show debugging ripng, 163  
 show hardware {cpu | disk | memory}, 14  
 show ip access-list [NAME], 180  
 show ip arp [IFNAME], 205  
 show ip bgp A.B.C.D [wide], 94  
 show ip bgp large-community-info, 90  
 show ip bgp [wide], 94  
 show ip dhcp binding  
   [<DHCP4POOL|A.B.C.D>], 44  
 show ip dhcp pool, 44  
 show ip eigrp [vrf NAME] interface, 125  
 show ip eigrp [vrf NAME] topology, 125  
 show ip igmp groups, 168  
 show ip igmp groups retransmissions, 168  
 show ip igmp interface, 168  
 show ip igmp join, 168  
 show ip igmp sources, 168  
 show ip igmp sources retransmissions, 168  
 show ip igmp statistics, 169  
 show ip mroute vrf all count [json], 169  
 show ip mroute vrf all summary [json],  
   169  
 show ip mroute [vrf NAME] count [json],  
   169  
 show ip mroute [vrf NAME] summary  
   [json], 169  
 show ip mroute [vrf NAME] [A.B.C.D  
   [A.B.C.D]] [fill] [json], 169  
 show ip multicast, 169  
 show ip multicast count vrf all [json],  
   170  
 show ip multicast count [vrf NAME]  
   [json], 170  
 show ip ospf, 148  
 show ip ospf database, 148  
 show ip ospf database (asbr-  
   summary|external|network|router|summary),  
   148  
 show ip ospf database  
   (asbr-summary|external|network|router|summary)  
   adv-router ADV-ROUTER, 148  
 show ip ospf database  
   (asbr-summary|external|network|router|summary)  
   LINK-STATE-ID, 148  
 show ip ospf database  
   (asbr-summary|external|network|router|summary)  
   LINK-STATE-ID adv-router ADV-ROUTER,  
   148  
 show ip ospf database  
   (asbr-summary|external|network|router|summary)  
   LINK-STATE-ID self-originate, 148  
 show ip ospf database  
   (asbr-summary|external|network|router|summary)  
   self-originate, 148  
 show ip ospf database  
   (opaque-link|opaque-area|opaque-external)  
   adv-router ADV-ROUTER, 149  
 show ip ospf database  
   (opaque-link|opaque-area|opaque-external)  
   LINK-STATE-ID, 149  
 show ip ospf database  
   (opaque-link|opaque-area|opaque-external)  
   LINK-STATE-ID adv-router ADV-ROUTER,  
   149  
 show ip ospf database  
   (opaque-link|opaque-area|opaque-external)  
   LINK-STATE-ID self-originate, 149  
 show ip ospf database  
   (opaque-link|opaque-area|opaque-external)  
   self-originate, 149  
 show ip ospf database max-age, 148  
 show ip ospf database self-originate, 148  
 show ip ospf interface [INTERFACE], 148  
 show ip ospf neighbor, 148  
 show ip ospf neighbor detail, 148  
 show ip ospf neighbor INTERFACE, 148  
 show ip ospf neighbor INTERFACE detail,  
   148  
 show ip ospf route, 149  
 show ip ospf router-info, 150  
 show ip ospf router-info pce, 150  
 show ip pim assert, 169  
 show ip pim assert-internal, 169  
 show ip pim assert-metric, 169  
 show ip pim assert-winner-metric, 169  
 show ip pim bsm-database, 170  
 show ip pim bsr, 170  
 show ip pim bsrp-info, 170  
 show ip pim group-type, 169  
 show ip pim interface, 169  
 show ip pim join, 169  
 show ip pim local-membership, 169  
 show ip pim mlag summary, 170  
 show ip pim mlag summary [json], 169  
 show ip pim mlag upstream, 170  
 show ip pim mlag [vrf NAME|all]  
   interface [detail|WORD] [json], 169  
 show ip pim neighbor, 169  
 show ip pim nexthop, 170  
 show ip pim nexthop-lookup, 170  
 show ip pim rp-info, 170  
 show ip pim rpf, 170  
 show ip pim secondary, 170  
 show ip pim state, 170

show ip pim upstream, 170  
 show ip pim upstream-join-desired, 170  
 show ip pim upstream-rpf, 170  
 show ip prefix-list, 21  
 show ip prefix-list detail, 21  
 show ip prefix-list detail NAME, 21  
 show ip prefix-list NAME, 21  
 show ip prefix-list NAME A.B.C.D/M, 21  
 show ip prefix-list NAME A.B.C.D/M  
   first-match, 21  
 show ip prefix-list NAME A.B.C.D/M  
   longer, 21  
 show ip prefix-list NAME seq NUM, 21  
 show ip prefix-list summary, 21  
 show ip prefix-list summary NAME, 21  
 show ip rip, 161  
 show ip rip status, 161  
 show ip ripng, 163  
 show ip rpf, 170  
 show ip ssh client known-host  
   <A.B.C.D|X:X::X:X|HOST>, 7  
 show ipv6 ospf6, 154  
 show ipv6 ospf6 database, 154  
 show ipv6 ospf6 interface, 154  
 show ipv6 ospf6 neighbor, 154  
 show ipv6 ospf6 request-list A.B.C.D, 154  
 show ipv6 ospf6 zebra, 154  
 show ipv6 route ospf6, 154  
 show isis database, 130  
 show isis database <LSP id> [detail], 130  
 show isis database detail <LSP id>, 130  
 show isis database [detail], 130  
 show isis hostname, 129  
 show isis interface, 129  
 show isis interface <interface name>, 129  
 show isis interface detail, 129  
 show isis neighbor, 129  
 show isis neighbor <System Id>, 129  
 show isis neighbor detail, 129  
 show isis route [level-1|level-2], 130  
 show isis summary, 129  
 show isis topology, 130  
 show isis topology [level-1|level-2], 130  
 show license, 46  
 show log all [follow], 28  
 show log frr [follow], 28  
 show log ipsec [follow], 28  
 show log kernel [follow], 28  
 show log mender [follow], 28  
 show log ntpd [follow], 28  
 show log snmpd [follow], 28  
 show log soolog [follow], 28  
 show log ssh [follow], 28  
 show log vpp [follow], 28  
 show login blocked-ips, 5  
 show login failures, 4  
 show memory control-plane, 16  
 show memory control-plane details, 16  
 show mpls ldp discovery [detail], 121  
 show mpls ldp ipv4 discovery [detail],  
   121  
 show mpls ldp ipv4 interface, 121  
 show mpls ldp ipv4|ipv6 binding, 121  
 show mpls ldp ipv6 discovery [detail],  
   121  
 show mpls ldp ipv6 interface, 121  
 show mpls ldp neighbor [A.B.C.D], 121  
 show mpls ldp neighbor [A.B.C.D]  
   capabilities, 121  
 show mpls ldp neighbor [A.B.C.D] detail,  
   121  
 show ntp sources stats, 36  
 show ntp sources [json], 35  
 show policy-map [NAME], 177  
 show processes, 9  
 show processes detailed process-id (0-  
   1000000), 12  
 show processes memory, 12  
 show route-map [WORD], 23  
 show system service status SERVICE, 32  
 show thread cpu control-plane [details  
   [r|w|t|e|x]], 17  
 show users, 5  
 show version, 9  
 show vrf, 182  
 show wireguard [(1-1024) PEER] stats  
   [json], 198  
 show wireguard [(1-1024) PEER] [json],  
   196  
 show [ip] bgp <ipv4|ipv6> community, 96  
 show [ip] bgp <ipv4|ipv6> community  
   COMMUNITY, 96  
 show [ip] bgp <ipv4|ipv6> community  
   COMMUNITY exact-match, 96  
 show [ip] bgp <ipv4|ipv6>  
   community-list WORD, 96  
 show [ip] bgp <ipv4|ipv6>  
   community-list WORD exact-match,  
   96  
 show [ip] bgp <ipv4|ipv6>  
   large-community, 96  
 show [ip] bgp <ipv4|ipv6>  
   large-community LARGE-COMMUNITY,  
   96  
 show [ip] bgp <ipv4|ipv6>  
   large-community LARGE-COMMUNITY  
   exact-match, 96  
 show [ip] bgp <ipv4|ipv6>

large-community LARGE-COMMUNITY  
 json, 96  
 show [ip] bgp <ipv4|ipv6>  
   large-community-list WORD, 96  
 show [ip] bgp <ipv4|ipv6>  
   large-community-list WORD  
   exact-match, 96  
 show [ip] bgp <ipv4|ipv6>  
   large-community-list WORD json, 96  
 show [ip] bgp ipv4 vpn, 97  
 show [ip] bgp ipv6 vpn, 97  
 show [ip] bgp regexp LINE, 95  
 show [ip] bgp summary, 95  
 show [ip] bgp view NAME, 65  
 snmp-server user USER auth <md5|sha>  
   PASSWORD [priv des56 PRIV], 33  
 source A.B.C.D, 40  
 source-ip <A.B.C.D|X:X::X:X>, 185  
 spf-interval (1-120), 127  
 spf-interval [level-1 | level-2] (1-120),  
   127  
 subject-alt-name LINE, 189  
 subject-name LINE..., 189  
 system config backup list local, 31  
 system config backup list  
   removable-storage, 31  
 system config backup list ssh HOST USER  
   PATH, 30  
 system config backup local NAME, 31  
 system config backup removable-storage  
   NAME, 31  
 system config backup ssh HOST USER PATH,  
   30  
 system config restore local NAME, 32  
 system config restore removable-storage  
   NAME, 31  
 system config restore ssh HOST USER  
   PATH, 31  
 system service enable soomon, 32  
 system service restart SERVICE, 32  
 system tune apply default, 53  
 system tune apply PROFILE, 53  
 system tune profile TPROF, 49  
 system update enable, 29  
 system update inventory-poll-interval (5-  
   2147483647), 29  
 system update offline commit, 30  
 system update offline install ARTIFACT,  
   30  
 system update offline list, 30  
 system update server-url WORD, 29  
 system update update-poll-interval (5-  
   2147483647), 29  
 table-map ROUTE-MAP-NAME, 76  
 tcp syn-flood limit (1-4294967295), 33  
 timers basic UPDATE TIMEOUT GARBAGE, 161  
 timers throttle spf (0-600000)  
   (0-600000) (0-600000), 140  
 timers throttle spf DELAY  
   INITIAL-HOLDTIME MAX-HOLDTIME, 152  
 transmit-interval (10-60000), 54  
 transport udp (1-65535), 40  
 tunnel destination <A.B.C.D|X:X::X:X>,  
   183  
 tunnel mode gre, 183  
 tunnel mode gre multipoint, 183  
 tunnel mode ipip, 183  
 tunnel mode ipip multipoint, 183  
 tunnel protection ipsec profile  
   IPSECPROFILE, 183  
 tunnel source <A.B.C.D|X:X::X:X>, 183  
 update-delay MAX-DELAY, 76  
 update-delay MAX-DELAY ESTABLISH-WAIT, 76  
 user password, 4  
 username USER, 6  
 version VERSION, 156  
 vrf (VRF\_NAME), 181  
 vrf VRF, 195  
 wireguard peer PEER, 195  
 wireguard port (1000-65535), 195  
 wireguard private-key X25519KEY, 195  
 wireguard source A.B.C.D, 195  
 write file, 9  
 write terminal, 9  
 write-quanta (1-64), 94  
 configure [terminal], 9  
   configuration command, 9  
 continue, 25  
   configuration command, 25  
 continue N, 25  
   configuration command, 25  
 control-plane, 51  
   configuration command, 51  
 cpu, 51, 52  
 cpu main, 50  
 cpu main [exclusive] (1-256)  
   configuration command, 50  
 cpu weight, 50-52  
 cpu weight (1-10000)  
   configuration command, 50-52  
 cpu worker, 50  
 cpu worker [exclusive] (1-256)...  
   configuration command, 50  
 cpu [exclusive] (1-256)...  
   configuration command, 51, 52  
 crypto ikev2 dpd (1-3600), 200  
   configuration command, 200  
 crypto ikev2 keyring IKEKEYRING, 201

configuration command, 201  
 crypto ikev2 proposal IKEPOSAL, 200  
   configuration command, 200  
 crypto ipsec transform-set IPSECTS esp {hmac  
   HMAC\_ALG |cipher CIPHER\_ALG}, 203  
 crypto ipsec transform-set IPSECTS esp {hmac  
   HMAC\_ALG |cipher CIPHER\_ALG}  
   configuration command, 203  
 crypto ipsec transform-set IPSECTS ah hmac  
   HMAC\_ALG, 203  
   configuration command, 203  
 crypto key generate raw, 188  
 crypto key generate rawraw label LABEL  
   bytes (32-1024)  
   configuration command, 188  
 crypto key generate rsa, 188  
 crypto key generate rsa label NAME modulus  
   (2048|4096)  
   configuration command, 188  
 crypto key generate ssh, 188  
 crypto key generate ssh modulus (2048|4096)  
   configuration command, 188  
 crypto key generate x25519, 188  
 crypto key generate x25519 label LABEL  
   configuration command, 188  
 crypto key zeroize, 193  
 crypto key zeroize RSAKEY  
   configuration command, 193  
 crypto pki authenticate, 188  
 crypto pki authenticate TP  
   configuration command, 188  
 crypto pki enroll, 189  
 crypto pki enroll TP  
   configuration command, 189  
 crypto pki import, 190  
 crypto pki import TP certificate  
   configuration command, 190  
 crypto pki trustpoint, 188  
 crypto pki trustpoint NAME  
   configuration command, 188

## D

data-plane, 49  
   configuration command, 49  
 debug acl event, 181  
 debug bonc event, 210  
 debug bridge event, 208  
 debug eigrp packets, 125  
   configuration command, 125  
 debug eigrp transmit, 125  
   configuration command, 125  
 debug igmp, 171  
   configuration command, 171  
 debug ipfix event, 41

debug ipsec event, 205  
 debug ipsec vici detail, 205  
 debug ipsec vici json, 205  
 debug isis adj-packets, 130  
   configuration command, 130  
 debug isis checksum-errors, 130  
   configuration command, 130  
 debug isis events, 130  
   configuration command, 130  
 debug isis local-updates, 130  
   configuration command, 130  
 debug isis packet-dump, 130  
   configuration command, 130  
 debug isis protocol-errors, 130  
   configuration command, 130  
 debug isis route-events, 130  
   configuration command, 130  
 debug isis snp-packets, 130  
   configuration command, 130  
 debug isis spf-events, 131  
   configuration command, 131  
 debug isis spf-statistics, 131  
   configuration command, 131  
 debug isis spf-triggers, 131  
   configuration command, 131  
 debug isis update-packets, 131  
   configuration command, 131  
 debug mroute, 171  
   configuration command, 171  
 debug mtrace, 171  
   configuration command, 171  
 debug nat44 event, 174  
 debug ospf event, 150  
   configuration command, 150  
 debug ospf ism, 150  
   configuration command, 150  
 debug ospf ism (status|events|timers), 150  
   configuration command, 150  
 debug ospf lsa, 150  
   configuration command, 150  
 debug ospf lsa (generate|flooding|refresh), 150  
   configuration command, 150  
 debug ospf nsm, 150  
   configuration command, 150  
 debug ospf nsm (status|events|timers), 150  
   configuration command, 150  
 debug ospf nssa, 150  
   configuration command, 150  
 debug ospf packet (hello|dd|ls-request|ls-update|ls-ack|al  
   (send|recv) [detail], 150  
   configuration command, 150  
 debug ospf zebra, 150  
   configuration command, 150  
 debug ospf zebra (interface|redistribute), 151





configuration command, 93  
 dump bgp updates-et PATH [INTERVAL], 93  
 configuration command, 93

## E

echo-interval (*10-60000*), 55  
 configuration command, 55  
 enable config password PASSWORD, 4  
 configuration command, 4  
 enable password PASSWORD, 3  
 configuration command, 3  
 encapsulation default, 206  
 configuration command, 206  
 encapsulation dot1ad (1-4094) dot1q (*1-4094*),  
 206  
 configuration command, 206  
 encapsulation dot1q (1-4094) [exact]  
 [second-dot1q (1-4094)], 206  
 configuration command, 206  
 encryption ALGORITHM, 200  
 configuration command, 200  
 endpoint A.B.C.D port (*1000-65535*), 196  
 enrollment terminal pem, 189  
 configuration command, 189  
 Exit Policy, 22

## F

find COMMAND..., 17  
 configuration command, 17  
 flow exporter, 40  
 configuration command, 40  
 flow monitor, 41  
 configuration command, 41  
 flush\_timer TIME, 163  
 configuration command, 163

## G

group GROUP, 200  
 configuration command, 200

## H

hostname dynamic, 126  
 configuration command, 126  
 hostname HOSTNAME, 7  
 configuration command, 7

## I

identity address <A.B.C.D|X:X::X:X>, 201  
 configuration command, 201  
 identity email MAIL, 201  
 configuration command, 201  
 identity fqdn FQDN, 201  
 configuration command, 201

identity local address <A.B.C.D|X:X::X:X>,  
 201  
 configuration command, 201  
 identity local email MAIL, 201  
 configuration command, 201  
 identity local fqdn FQDN, 201  
 configuration command, 201  
 import vrf VRFNAME, 92  
 configuration command, 92  
 import|export vpn, 92  
 configuration command, 92  
 included-address A.B.C.D A.B.C.D, 43  
 ingress-replication A.B.C.D, 185  
 configuration command, 185  
 integrity ALGORITHM, 200  
 configuration command, 200  
 interface bundle-ether (*1-65535*), 209  
 configuration command, 209  
 interface IFNAME area (*0-4294967295*), 152  
 configuration command, 152  
 interface IFNAME area A.B.C.D, 152  
 configuration command, 152  
 interface IFNAME.(*0-4095*), 206  
 configuration command, 206  
 interface mpls-tunnel, 186  
 configuration command, 186  
 interface nve (*0-1023*), 185  
 configuration command, 185  
 interface tunnel, 183  
 interface tunnel [vrf VRF] (*0-1023*)  
 configuration command, 183  
 interface wireguard (*0-1023*), 195  
 configuration command, 195  
 ip access-group ACL4 in, 180  
 configuration command, 180  
 ip access-group ACL4 in out, 180  
 configuration command, 180  
 ip access-group ACL4 out, 180  
 configuration command, 180  
 ip access-list ACL4, 178  
 configuration command, 178  
 ip dhcp pool DHCP4POOL, 42  
 ip dhcp server, 44  
 ip flow monitor output, 41  
 configuration command, 41  
 ip host NAME A.B.C.D, 8  
 ip igmp, 167  
 configuration command, 167  
 ip igmp generate-query-once [version (2-3)],  
 166  
 configuration command, 166  
 ip igmp join A.B.C.D [A.B.C.D], 167  
 configuration command, 167  
 ip igmp last-member-query-count (*1-7*), 168

- configuration command, 168
- ip igmp last-member-query-interval (*I-255*), 168
  - configuration command, 168
- ip igmp query-interval (*I-1800*), 167
  - configuration command, 167
- ip igmp query-max-response-time (*10-250*), 167
  - configuration command, 167
- ip igmp version (*2-3*), 167
  - configuration command, 167
- ip mroute A.B.C.D/M A.B.C.D (*I-255*), 168
  - configuration command, 168
- ip mroute A.B.C.D/M INTERFACE (*I-255*), 168
  - configuration command, 168
- ip mroute INTERFACE A.B.C.D [A.B.C.D], 168
  - configuration command, 168
- ip multicast boundary oil WORD, 168
  - configuration command, 168
- ip multicast rpf-lookup-mode WORD, 166
  - configuration command, 166
- ip name-server A.B.C.D, 8
- ip nat inside, 174
  - configuration command, 174
- ip nat inside source static <tcp|udp>
  - A.B.C.D (1-65535) A.B.C.D (*I-65535*), 173
    - configuration command, 173
- ip nat inside source static A.B.C.D A.B.C.D, 172
  - configuration command, 172
- ip nat outside, 174
  - configuration command, 174
- ip nat pool PNAT44 A.B.C.D [ A.B.C.D ], 174
  - configuration command, 174
- ip ospf area (A.B.C.D|*(0-4294967295)*), 146
  - configuration command, 146
- ip ospf area AREA [ADDR], 145
  - configuration command, 145
- ip ospf authentication message-digest, 145
  - configuration command, 145
- ip ospf authentication-key AUTH\_KEY, 145
  - configuration command, 145
- ip ospf bfd, 57
  - configuration command, 57
- ip ospf cost (*I-65535*), 145
  - configuration command, 145
- ip ospf dead-interval (*I-65535*), 145
  - configuration command, 145
- ip ospf dead-interval minimal
  - hello-multiplier (*2-20*), 145
    - configuration command, 145
- ip ospf hello-interval (*I-65535*), 146
  - configuration command, 146
- ip ospf message-digest-key KEYID md5 KEY, 145
  - configuration command, 145
- ip ospf network (*broadcast|non-broadcast|point-to-multipoint|point-to-point*), 146
  - configuration command, 146
- ip ospf priority (*0-255*), 146
  - configuration command, 146
- ip ospf retransmit-interval (*I-65535*), 146
  - configuration command, 146
- ip ospf transmit-delay (*1-65535*) [A.B.C.D], 146
  - configuration command, 146
- ip pim, 167
  - configuration command, 167
- ip pim active-active, 167
  - configuration command, 167
- ip pim bfd, 167
  - configuration command, 167
- ip pim bsm, 167
  - configuration command, 167
- ip pim drpriority (*I-4294967295*), 167
  - configuration command, 167
- ip pim ecmp, 165
  - configuration command, 165
- ip pim ecmp rebalance, 165
  - configuration command, 165
- ip pim hello (*1-180*) (*I-180*), 167
  - configuration command, 167
- ip pim join-prune-interval (*60-600*), 165
  - configuration command, 165
- ip pim keep-alive-timer (*31-60000*), 166
  - configuration command, 166
- ip pim packets (*I-100*), 166
  - configuration command, 166
- ip pim register-accept-list PLIST, 165
  - configuration command, 165
- ip pim register-suppress-time (*5-60000*), 166
  - configuration command, 166
- ip pim rp A.B.C.D A.B.C.D/M, 165
  - configuration command, 165
- ip pim send-v6-secondary, 166
  - configuration command, 166
- ip pim spt-switchover infinity-and-beyond, 165
  - configuration command, 165
- ip pim ssm prefix-list WORD, 166
  - configuration command, 166
- ip pim unicast-bsm, 167
  - configuration command, 167
- ip prefix-list NAME (permit|deny) PREFIX [le LEN] [ge LEN], 20
  - configuration command, 20
- ip prefix-list NAME description DESC, 21
  - configuration command, 21
- ip prefix-list NAME seq NUMBER (permit|deny) PREFIX [le LEN] [ge

- LEN], 20
  - configuration command, 20
- ip prefix-list sequence-number, 21
  - configuration command, 21
- ip rip authentication key-chain KEY-CHAIN, 161
  - configuration command, 161
- ip rip authentication mode md5, 160
  - configuration command, 160
- ip rip authentication mode text, 160
  - configuration command, 160
- ip rip authentication string STRING, 160
  - configuration command, 160
- ip rip receive version VERSION, 157
  - configuration command, 157
- ip rip send version VERSION, 157
  - configuration command, 157
- ip route NETWORK GATEWAY table TABLENO
  - nexthop-vrf VRFNAME DISTANCE vrf VRFNAME, 164
  - configuration command, 164
- ip split-horizon, 156
  - configuration command, 156
- ip ssh client, 7
  - configuration command, 7
- ip ssh pubkey-chain, 6
  - configuration command, 6
- ip verify unicast source, 33
- ip verify unicast source reachable-via [rx | any]
  - configuration command, 33
- ip vrf forwarding NAME, 181
  - configuration command, 181
- ipv6 access-group ACL6 in, 180
  - configuration command, 180
- ipv6 access-group ACL6 in out, 180
  - configuration command, 180
- ipv6 access-group ACL6 out, 180
  - configuration command, 180
- ipv6 enable, 37
  - configuration command, 37
- ipv6 nd adv-interval-option, 39
- ipv6 nd dnssl domain-name-suffix [lifetime], 39
- ipv6 nd home-agent-config-flag, 39
- ipv6 nd home-agent-lifetime (0-65520), 39
- ipv6 nd home-agent-preference (0-65535), 39
- ipv6 nd managed-config-flag, 38
- ipv6 nd mtu (1-65535), 39
- ipv6 nd other-config-flag, 38
- ipv6 nd prefix ipv6prefix [valid-lifetime] [preferred-lifetime] [off-link] [no-autoconfig] [router-address], 37
  - configuration command, 37
- ipv6 nd ra-fast-retrans, 38
- ipv6 nd ra-hop-limit (0-255), 38
- ipv6 nd ra-interval msec (70-1800000), 38
- ipv6 nd ra-lifetime (0-9000), 38
- ipv6 nd ra-retrans-interval (0-4294967295), 38
- ipv6 nd rdns ipv6address [lifetime], 39
- ipv6 nd reachable-time (1-3600000), 38
- ipv6 nd router-preference (high|medium|low), 39
- ipv6 nd suppress-ra, 37
  - configuration command, 37
- ipv6 ospf6 bfd, 57
  - configuration command, 57
- ipv6 ospf6 cost COST, 153
  - configuration command, 153
- ipv6 ospf6 dead-interval DEADINTERVAL, 153
  - configuration command, 153
- ipv6 ospf6 hello-interval HELLOINTERVAL, 153
  - configuration command, 153
- ipv6 ospf6 network (broadcast|point-to-point), 154
  - configuration command, 154
- ipv6 ospf6 priority PRIORITY, 153
  - configuration command, 153
- ipv6 ospf6 retransmit-interval RETRANSMITINTERVAL, 153
  - configuration command, 153
- ipv6 ospf6 transmit-delay TRANSMITDELAY, 154
  - configuration command, 154
- ipv6 route NETWORK from SRCPREFIX GATEWAY
  - table TABLENO nexthop-vrf VRFNAME DISTANCE vrf VRFNAME, 164
  - configuration command, 164
- is-type [level-1 | level-1-2 | level-2-only], 127
  - configuration command, 127
- isis bfd, 56
  - configuration command, 56
- isis bfd profile BFDPROF, 56
  - configuration command, 56
- isis circuit-type [level-1 | level-1-2 | level-2], 128
  - configuration command, 128
- isis csnp-interval (1-600), 128
  - configuration command, 128
- isis csnp-interval (1-600) [level-1 | level-2], 128
  - configuration command, 128
- isis hello padding, 128
  - configuration command, 128
- isis hello-interval (1-600), 128
  - configuration command, 128
- isis hello-interval (1-600) [level-1 | level-2], 128
  - configuration command, 128
- isis hello-multiplier (2-100), 128

configuration command, 128  
 isis hello-multiplier (2-100) [level-1 | level-2], 128  
     configuration command, 128  
 isis metric [(0-255) | (0-16777215)], 128  
     configuration command, 128  
 isis metric [(0-255) | (0-16777215)] [level-1 | level-2], 128  
     configuration command, 128  
 isis network point-to-point, 128  
     configuration command, 128  
 isis passive, 129  
     configuration command, 129  
 isis password [clear | md5] <password>, 129  
     configuration command, 129  
 isis priority (0-127), 129  
     configuration command, 129  
 isis priority (0-127) [level-1 | level-2], 129  
     configuration command, 129  
 isis psnp-interval (1-120), 129  
     configuration command, 129  
 isis psnp-interval (1-120) [level-1 | level-2], 129  
     configuration command, 129  
 isis three-way-handshake, 129  
     configuration command, 129

## K

key LINE .., 6  
     configuration command, 6  
 keyring local IKEKEYRING, 202  
     configuration command, 202  
 known-host <A.B.C.D|X:X::X:X|HOST>, 7  
     configuration command, 7

## L

l2vpn NAME type vpls, 186  
     configuration command, 186  
 label vpn export (0..1048575)|auto, 92  
     configuration command, 92  
 label WORD, 55  
     configuration command, 55  
 lease, 43  
 license check, 45  
     configuration command, 45  
 license generate license-request, 45  
 license generate license-request [terminal]  
     configuration command, 45  
 license import license, 45  
 lifetime <120-86400>, 202  
     configuration command, 202  
 Link State Advertisement, 132  
 Link State Announcement, 132

Link State Database, 132  
 Link-state routing protocol, 132  
 Link-state routing protocol advantages, 132  
 Link-state routing protocol disadvantages, 132  
 list, 9  
     configuration command, 9  
 log export removable-storage, 7  
     configuration command, 7  
 log export ssh HOST USER PATH, 7  
     configuration command, 7  
 log facility [FACILITY], 28  
 log file [LEVEL], 27  
 log monitor [LEVEL], 27  
 log record-priority, 28  
 log rotate max-file-size SIZE, 26  
     configuration command, 26  
 log rotate max-files (1-1000), 26  
     configuration command, 26  
 log rotate max-use SIZE, 26  
     configuration command, 26  
 log syslog A.B.C.D tcp, 27  
 log syslog HOST loki, 27  
 log syslog [LEVEL], 27  
 log timestamp precision (0-6), 28  
 log-adjacency-changes, 126  
     configuration command, 126  
 log-adjacency-changes [detail], 140  
     configuration command, 140  
 login block-for TIME attempts ATTEMPT within PERIOD, 5  
     configuration command, 5  
 login unblock <A.B.C.D|X:X::X:X|all>, 5  
     configuration command, 5  
 LSA flooding, 132  
 lsp-gen-interval (1-120), 127  
     configuration command, 127  
 lsp-gen-interval [level-1 | level-2] (1-120), 127  
     configuration command, 127  
 lsp-refresh-interval [level-1 | level-2] (1-65235), 127  
     configuration command, 127

## M

management-plane, 52  
     configuration command, 52  
 match address local A.B.C.D, 201  
     configuration command, 201  
 match any, 175  
     configuration command, 175  
 match as-path AS\_PATH, 23  
     configuration command, 23  
 match certificate, 202

- configuration command, 202
- match community COMMUNITY\_LIST, 24
  - configuration command, 24
- match community WORD exact-match
  - [exact-match], 85
  - configuration command, 85
- match extcommunity WORD, 89
  - configuration command, 89
- match identity remote address
  - <A.B.C.D|X:X::X:X>, 202
  - configuration command, 202
- match identity remote email EMAIL, 202
  - configuration command, 202
- match identity remote fqdn FQDN, 202
  - configuration command, 202
- match interface WORD, 159
  - configuration command, 159
- match ip address ACCESS\_LIST, 23
  - configuration command, 23
- match ip address prefix-len 0-32, 23
  - configuration command, 23
- match ip address prefix-list PREFIX\_LIST, 23
  - configuration command, 23
- match ip address prefix-list WORD, 160
  - configuration command, 160
- match ip address WORD, 160
  - configuration command, 160
- match ip next-hop address IPV4\_ADDR, 23
  - configuration command, 23
- match ip next-hop prefix-list WORD, 160
  - configuration command, 160
- match ip next-hop WORD, 160
  - configuration command, 160
- match ipv6 address ACCESS\_LIST, 23
  - configuration command, 23
- match ipv6 address prefix-len 0-128, 23
  - configuration command, 23
- match ipv6 address prefix-list PREFIX\_LIST, 23
  - configuration command, 23
- match ipv6 next-hop IPV6\_ADDR, 23
  - configuration command, 23
- match large-community LINE [exact-match], 90
  - configuration command, 90
- match local-preference METRIC, 23
  - configuration command, 23
- match metric (0-4294967295), 160
  - configuration command, 160
- match metric METRIC, 23
  - configuration command, 23
- match peer A.B.C.D|X:X::X:X, 109
  - configuration command, 109
- match peer INTERFACE\_NAME, 24
  - configuration command, 24
- match peer IPV4\_ADDR, 24
  - configuration command, 24
- match peer IPV6\_ADDR, 24
  - configuration command, 24
- match source-instance NUMBER, 24
  - configuration command, 24
- match source-protocol PROTOCOL\_NAME, 24
  - configuration command, 24
- match tag TAG, 23
  - configuration command, 23
- Matching Conditions, 22
- Matching Policy, 22
- max-lsp-lifetime (360-65535), 127
  - configuration command, 127
- max-lsp-lifetime [level-1 | level-2] (360-65535), 127
  - configuration command, 127
- max-metric router-lsa administrative, 141
  - configuration command, 141
- max-metric router-lsa
  - [on-startup|on-shutdown] (5-86400), 141
  - configuration command, 141
- member pseudowire PW, 186
  - configuration command, 186
- member vni (1-16777214), 185
  - configuration command, 185
- member vni (1-16777214) associate-vrf, 185
  - configuration command, 185
- memory heap main, 50
- memory heap main SIZE
  - configuration command, 50
- memory heap stats, 50
- memory heap stats SIZE
  - configuration command, 50
- memory max, 50, 52, 53
- memory max SIZE
  - configuration command, 50, 52, 53
- memory packet-buffer count, 51
- memory packet-buffer count (16384-1049776)
  - configuration command, 51
- memory packet-buffer size, 51
- memory packet-buffer size (2048-65536)
  - configuration command, 51
- metric-style [narrow | transition | wide], 126
  - configuration command, 126
- mode transport, 203
  - configuration command, 203
- monitor session (1-66) destination
  - interface INTERFACE, 208
  - configuration command, 208
- monitor session (1-66) source interface
  - INTERFACE [both|rx|tx], 208

mtrace A.B.C.D [A.B.C.D], 170  
 configuration command, 170

## N

neighbor A.B.C.D|X.X::X.X|peer-group  
 route-map WORD import|export, 109  
 configuration command, 109

neighbor <A.B.C.D|X.X::X.X|WORD> bfd, 56  
 configuration command, 56

neighbor <A.B.C.D|X.X::X.X|WORD> bfd  
 check-control-plane-failure, 56  
 configuration command, 56

neighbor <A.B.C.D|X.X::X.X|WORD> bfd  
 profile BFDPROF, 56  
 configuration command, 56

neighbor A.B.C.D, 156  
 configuration command, 156

neighbor A.B.C.D graceful-restart, 73  
 configuration command, 73

neighbor A.B.C.D graceful-restart-disable, 73  
 configuration command, 73

neighbor A.B.C.D graceful-restart-helper, 73  
 configuration command, 73

neighbor A.B.C.D route-server-client, 109  
 configuration command, 109

neighbor lsr-id A.B.C.D, 186  
 configuration command, 186

neighbor PEER attribute-unchanged  
 [{as-path|next-hop|med}], 78  
 configuration command, 78

neighbor PEER distribute-list NAME [in|out],  
 81  
 configuration command, 81

neighbor PEER filter-list NAME [in|out], 81  
 configuration command, 81

neighbor PEER override-capability, 82  
 configuration command, 82

neighbor PEER peer-group PNAME, 81  
 configuration command, 81

neighbor PEER port PORT, 79  
 configuration command, 79

neighbor PEER prefix-list NAME [in|out], 81  
 configuration command, 81

neighbor PEER remote-as ASN, 77  
 configuration command, 77

neighbor PEER remote-as external, 77  
 configuration command, 77

neighbor PEER remote-as internal, 77  
 configuration command, 77

neighbor PEER route-map NAME [in|out], 81  
 configuration command, 81

neighbor PEER route-reflector-client, 97  
 configuration command, 97

neighbor PEER send-community, 79  
 configuration command, 79

neighbor PEER solo, 81  
 configuration command, 81

neighbor PEER strict-capability-match, 81  
 configuration command, 81

neighbor PEER-GROUP route-server-client, 109  
 configuration command, 109

neighbor WORD peer-group, 81  
 configuration command, 81

neighbor X.X::X.X route-server-client, 109  
 configuration command, 109

net XX.XXXX. ... .XXX.XX, 126  
 configuration command, 126

network A.B.C.D/M, 42, 73  
 configuration command, 73

network A.B.C.D/M area (0-4294967295), 141  
 configuration command, 141

network A.B.C.D/M area A.B.C.D, 141  
 configuration command, 141

network IFNAME, 155, 163  
 configuration command, 155, 163

network NETWORK, 123, 155, 163  
 configuration command, 123, 155, 163

nexthop vpn export A.B.C.D|X.X::X.X, 92  
 configuration command, 92

no agentx, 33  
 configuration command, 33

no aggregate-address A.B.C.D/M, 74  
 configuration command, 74

no aggregate-address X.X::X.X/M, 75  
 configuration command, 75

no allowed-ip, 195

no allowed-ip [A.B.C.D/M]  
 configuration command, 195

no area (0-4294967295) authentication, 144  
 configuration command, 144

no area (0-4294967295) export-list NAME, 144  
 configuration command, 144

no area (0-4294967295) filter-list prefix  
 NAME in, 144  
 configuration command, 144

no area (0-4294967295) filter-list prefix  
 NAME out, 144  
 configuration command, 144

no area (0-4294967295) import-list NAME, 144  
 configuration command, 144

no area (0-4294967295) range A.B.C.D/M, 142  
 configuration command, 142

no area (0-4294967295) shortcut, 143  
 configuration command, 143

no area (0-4294967295) stub, 143  
 configuration command, 143

no area (0-4294967295) stub no-summary, 143  
 configuration command, 143

- no area (0-4294967295) virtual-link A.B.C.D, 143
  - configuration command, 143
- no area A.B.C.D authentication, 144
  - configuration command, 144
- no area A.B.C.D default-cost (0-16777215), 143
  - configuration command, 143
- no area A.B.C.D export-list NAME, 143
  - configuration command, 143
- no area A.B.C.D filter-list prefix NAME in, 144
  - configuration command, 144
- no area A.B.C.D filter-list prefix NAME out, 144
  - configuration command, 144
- no area A.B.C.D import-list NAME, 144
  - configuration command, 144
- no area A.B.C.D range A.B.C.D/M, 142
  - configuration command, 142
- no area A.B.C.D range IPV4\_PREFIX not-advertise, 142
  - configuration command, 142
- no area A.B.C.D range IPV4\_PREFIX substitute IPV4\_PREFIX, 142
  - configuration command, 142
- no area A.B.C.D shortcut, 143
  - configuration command, 143
- no area A.B.C.D stub, 143
  - configuration command, 143
- no area A.B.C.D stub no-summary, 143
  - configuration command, 143
- no area A.B.C.D virtual-link A.B.C.D, 143
  - configuration command, 143
- no area-password, 126
  - configuration command, 126
- no auto-cost reference-bandwidth, 141, 153
  - configuration command, 141, 153
- no banner motd, 5
  - configuration command, 5
- no bgp as-path access-list WORD, 82
  - configuration command, 82
- no bgp as-path access-list WORD permit|deny LINE, 82
  - configuration command, 82
- no bgp community-list [standard|expanded] NAME, 85
  - configuration command, 85
- no bgp extcommunity-list expanded NAME, 88
  - configuration command, 88
- no bgp extcommunity-list NAME, 88
  - configuration command, 88
- no bgp extcommunity-list standard NAME, 88
  - configuration command, 88
- no bgp large-community-list expanded NAME, 90
  - configuration command, 90
- no bgp large-community-list NAME, 90
  - configuration command, 90
- no bgp large-community-list standard NAME, 90
  - configuration command, 90
- no capability opaque, 149
  - configuration command, 149
- no class CNAME, 176
  - configuration command, 176
- no class-map CNAM, 175
  - configuration command, 175
- no cpu main, 50
- no cpu main [[exclusive] (1-256)]
  - configuration command, 50
- no cpu weight, 50-52
- no cpu weight [(1-10000)]
  - configuration command, 50-52
- no cpu worker, 50-52
- no cpu worker [[exclusive] (1-256)]
  - configuration command, 50-52
- no crypto pki trustpoint, 193
- no crypto pki trustpoint TPNAME
  - configuration command, 193
- no debug isis adj-packets, 130
  - configuration command, 130
- no debug isis checksum-errors, 130
  - configuration command, 130
- no debug isis events, 130
  - configuration command, 130
- no debug isis local-updates, 130
  - configuration command, 130
- no debug isis packet-dump, 130
  - configuration command, 130
- no debug isis protocol-errors, 130
  - configuration command, 130
- no debug isis route-events, 130
  - configuration command, 130
- no debug isis snp-packets, 131
  - configuration command, 131
- no debug isis spf-events, 131
  - configuration command, 131
- no debug isis spf-statistics, 131
  - configuration command, 131
- no debug isis spf-triggers, 131
  - configuration command, 131
- no debug isis update-packets, 131
  - configuration command, 131
- no debug ospf event, 150
  - configuration command, 150
- no debug ospf ism, 150
  - configuration command, 150
- no debug ospf ism (status|events|timers), 150
  - configuration command, 150
- no debug ospf lsa, 150



- configuration command, 150
- no debug ospf lsa (*generate|flooding|refresh*), 150
  - configuration command, 150
- no debug ospf nsm, 150
  - configuration command, 150
- no debug ospf nsm (*status|events|timers*), 150
  - configuration command, 150
- no debug ospf nssa, 150
  - configuration command, 150
- no debug ospf packet
  - (hello|dd|ls-request|ls-update|ls-ack|~~abl~~) ip flow monitor output, 41
  - (send|recv) [detail], 150
  - configuration command, 150
- no debug ospf zebra, 151
  - configuration command, 151
- no debug ospf zebra (*interface|redistribute*), 151
  - configuration command, 151
- no default-information originate, 147
  - configuration command, 147
- no default-metric, 148
  - configuration command, 148
- no default-metric (*I-16*), 159
  - configuration command, 159
- no distance (*I-255*), 148, 159
  - configuration command, 148, 159
- no distance (1-255) A.B.C.D/M, 159
  - configuration command, 159
- no distance (1-255) A.B.C.D/M ACCESS-LIST, 159
  - configuration command, 159
- no distance ospf, 148
  - configuration command, 148
- no distribute-list NAME out
  - (kernel|connected|static|rip|ospf), 148
  - configuration command, 148
- no domain-password, 126
  - configuration command, 126
- no dump bgp all [PATH] [INTERVAL], 93
  - configuration command, 93
- no dump bgp route-mrt [PATH] [INTERVAL], 94
  - configuration command, 94
- no dump bgp updates [PATH] [INTERVAL], 93
  - configuration command, 93
- no enable config password PASSWORD, 4
  - configuration command, 4
- no enable password PASSWORD, 3
  - configuration command, 3
- no hostname dynamic, 126
  - configuration command, 126
- no import vrf VRFNAME, 92
  - configuration command, 92
- no import|export vpn, 92
  - configuration command, 92
- no interface tunnel, 183
  - configuration command, 183
- no ip access-group ACL4 in, 180
  - configuration command, 180
- no ip access-group ACL4 in out, 180
  - configuration command, 180
- no ip access-group ACL4 out, 180
  - configuration command, 180
- no ip access-list ACL4, 178
  - configuration command, 178
- no ip flow monitor output, 41
  - configuration command, 41
- no ip host NAME A.B.C.D, 8
- no ip name-server A.B.C.D, 8
- no ip ospf area, 146
  - configuration command, 146
- no ip ospf area [ADDR], 145
  - configuration command, 145
- no ip ospf authentication-key, 145
  - configuration command, 145
- no ip ospf bfd, 57
  - configuration command, 57
- no ip ospf cost, 145
  - configuration command, 145
- no ip ospf dead-interval, 146
  - configuration command, 146
- no ip ospf hello-interval, 146
  - configuration command, 146
- no ip ospf message-digest-key, 145
  - configuration command, 145
- no ip ospf network, 146
  - configuration command, 146
- no ip ospf priority, 146
  - configuration command, 146
- no ip ospf retransmit interval, 146
  - configuration command, 146
- no ip ospf transmit-delay [(1-65535)] [A.B.C.D], 146
  - configuration command, 146
- no ip prefix-list NAME, 20
  - configuration command, 20
- no ip prefix-list NAME description [DESC], 21
  - configuration command, 21
- no ip prefix-list sequence-number, 21
  - configuration command, 21
- no ip rip authentication key-chain KEY-CHAIN, 161
  - configuration command, 161
- no ip rip authentication mode md5, 160
  - configuration command, 160
- no ip rip authentication mode text, 160
  - configuration command, 160
- no ip rip authentication string STRING, 161
  - configuration command, 161

no ip split-horizon, 156  
    configuration command, 156  
no ip vrf forwarding, 181  
no ip vrf forwarding [NAME]  
    configuration command, 181  
no ipv6 access-group ACL6 in, 180  
    configuration command, 180  
no ipv6 access-group ACL6 in out, 180  
    configuration command, 180  
no ipv6 access-group ACL6 out, 180  
    configuration command, 180  
no ipv6 nd adv-interval-option, 39  
no ipv6 nd dnssl domain-name-suffix  
    [lifetime], 39  
no ipv6 nd home-agent-config-flag, 39  
no ipv6 nd home-agent-lifetime (0-65520), 39  
no ipv6 nd home-agent-preference  
    [(0-65535)], 39  
no ipv6 nd managed-config-flag, 38  
no ipv6 nd mtu [(1-65535)], 39  
no ipv6 nd other-config-flag, 38  
no ipv6 nd ra-fast-retrans, 38  
no ipv6 nd ra-hop-limit [(0-255)], 38  
no ipv6 nd ra-interval [(1-1800)], 38  
no ipv6 nd ra-interval [msec (70-1800000)],  
    38  
no ipv6 nd ra-lifetime [(0-9000)], 38  
no ipv6 nd rdns ipv6address [lifetime], 39  
no ipv6 nd reachable-time [(1-3600000)], 38  
no ipv6 nd retrans-interval  
    [(0-4294967295)], 38  
no ipv6 nd router-preference (high|medium|low),  
    39  
no ipv6 nd suppress-ra, 37  
    configuration command, 37  
no ipv6 ospf6 bfd, 57  
    configuration command, 57  
no is-type, 127  
    configuration command, 127  
no isis bfd, 56  
    configuration command, 56  
no isis bfd profile BFDPROF, 56  
    configuration command, 56  
no isis circuit-type, 128  
    configuration command, 128  
no isis csnp-interval, 128  
    configuration command, 128  
no isis csnp-interval [level-1 | level-2],  
    128  
    configuration command, 128  
no isis hello-interval, 128  
    configuration command, 128  
no isis hello-interval [level-1 | level-2],  
    128  
    configuration command, 128  
no isis hello-multiplier, 128  
    configuration command, 128  
no isis hello-multiplier [level-1 |  
    level-2], 128  
    configuration command, 128  
no isis metric, 128  
    configuration command, 128  
no isis metric [level-1 | level-2], 128  
    configuration command, 128  
no isis network point-to-point, 128  
    configuration command, 128  
no isis passive, 129  
    configuration command, 129  
no isis password, 129  
    configuration command, 129  
no isis priority, 129  
    configuration command, 129  
no isis priority [level-1 | level-2], 129  
    configuration command, 129  
no isis psnp-interval, 129  
    configuration command, 129  
no isis psnp-interval [level-1 | level-2],  
    129  
    configuration command, 129  
no isis three-way-handshake, 129  
    configuration command, 129  
no key (1-65535), 6  
    configuration command, 6  
no key HASH, 6  
    configuration command, 6  
no known-host <A.B.C.D|X:X::X:X|HOST>, 7  
    configuration command, 7  
no label vpn export [(0..1048575)|auto], 92  
    configuration command, 92  
no log facility [FACILITY], 28  
no log file [LEVEL], 27  
no log monitor [LEVEL], 27  
no log record-priority, 28  
no log syslog A.B.C.D tcp, 27  
no log syslog HOST loki, 27  
no log syslog [LEVEL], 27  
no log-adjacency-changes, 126  
    configuration command, 126  
no log-adjacency-changes [detail], 140  
    configuration command, 140  
no lsp-gen-interval, 127  
    configuration command, 127  
no lsp-gen-interval [level-1 | level-2], 127  
    configuration command, 127  
no lsp-refresh-interval [level-1 | level-2],  
    127  
    configuration command, 127  
no match any, 175

- configuration command, 175
- no max-lsp-lifetime, 127
  - configuration command, 127
- no max-lsp-lifetime [level-1 | level-2], 127
  - configuration command, 127
- no max-metric router-lsa
  - [on-startup|on-shutdown|administrative], 141
  - configuration command, 141
- no memory heap main, 50
- no memory heap main [SIZE]
  - configuration command, 50
- no memory heap stats, 50
- no memory heap stats [SIZE]
  - configuration command, 50
- no memory max, 50, 52, 53
- no memory max [SIZE]
  - configuration command, 50, 52, 53
- no memory packet-buffer count, 51
- no memory packet-buffer count [(16384-1049776)]
  - configuration command, 51
- no memory packet-buffer size, 51
- no memory packet-buffer size [(2048-65536)]
  - configuration command, 51
- no metric-style, 126
  - configuration command, 126
- no neighbor <A.B.C.D|X:X::X:X|WORD> bfd, 56
  - configuration command, 56
- no neighbor <A.B.C.D|X:X::X:X|WORD> bfd
  - check-control-plane-failure, 56
  - configuration command, 56
- no neighbor <A.B.C.D|X:X::X:X|WORD> bfd
  - profile BFDPROF, 56
  - configuration command, 56
- no neighbor A.B.C.D, 156
  - configuration command, 156
- no neighbor PEER override-capability, 82
  - configuration command, 82
- no neighbor PEER route-reflector-client, 97
  - configuration command, 97
- no neighbor PEER strict-capability-match, 81
  - configuration command, 81
- no net XX.XXXX. ... .XXX.XX, 126
  - configuration command, 126
- no network A.B.C.D/M, 73
  - configuration command, 73
- no network A.B.C.D/M area (0-4294967295), 141
  - configuration command, 141
- no network A.B.C.D/M area A.B.C.D, 141
  - configuration command, 141
- no network IFNAME, 155
  - configuration command, 155
- no network NETWORK, 123, 155
  - configuration command, 123, 155
- no nexthop vpn export [A.B.C.D|X:X::X:X], 92
  - configuration command, 92
- no ntp, 37
  - configuration command, 37
- no ntp authentication, 35
  - configuration command, 35
- no ntp authentication-key, 35
- no ntp authentication-key (I-65535)
  - configuration command, 35
- no ntp server SERVER, 34
- no ntp server SERVER [OPTIONS]
  - configuration command, 34
- no ospf abr-type TYPE, 139
  - configuration command, 139
- no ospf opaque-lsa, 149
  - configuration command, 149
- no ospf rfc1583compatibility, 140
  - configuration command, 140
- no ospf router-id [A.B.C.D], 139
  - configuration command, 139
- no passive-interface IFNAME, 124, 156
  - configuration command, 124, 156
- no passive-interface INTERFACE, 140
  - configuration command, 140
- no pce address, 149
  - configuration command, 149
- no pce domain as (0-65535), 149
  - configuration command, 149
- no pce flag, 149
  - configuration command, 149
- no pce neighbor as (0-65535), 149
  - configuration command, 149
- no pce scope, 149
  - configuration command, 149
- no peer <A.B.C.D|X:X::X:X>\$peer
  - [{multihop|local-address <A.B.C.D|X:X::X:X>\$local|interface IFNAME\$ifname|vrf NAME\$vrf\_name}], 54
  - configuration command, 54
- no police, 176
  - configuration command, 176
- no policy-map NAME, 176
  - configuration command, 176
- no poll sleep, 51
- no poll sleep [(0-10000)]
  - configuration command, 51
- no proactive-arp, 142
  - configuration command, 142
- no profile WORD, 54
  - configuration command, 54
- no purge-originator, 126
  - configuration command, 126
- no rd vpn export [AS:NN|IP:nn], 91

- configuration command, 91
  - no record netflow <ipv4|ipv6> prefix-port, 41
    - configuration command, 41
  - no redistribute (*kernel|connected|static|rip|bgp*), 147
    - configuration command, 147
  - no redistribute bgp, 124, 158
    - configuration command, 124, 158
  - no redistribute connected, 124, 157
    - configuration command, 124, 157
  - no redistribute kernel, 124, 157
    - configuration command, 124, 157
  - no redistribute ospf, 124, 157
    - configuration command, 124, 157
  - no redistribute static, 124, 157
    - configuration command, 124, 157
  - no route A.B.C.D/M, 158
    - configuration command, 158
  - no route-map optimization, 26
    - configuration command, 26
  - no route-map vpn import|export [MAP], 92
    - configuration command, 92
  - no router bgp ASN, 64
    - configuration command, 64
  - no router eigrp (1-65535) [vrf NAME], 123
    - configuration command, 123
  - no router ospf [(1-65535)] vrf NAME, 139
    - configuration command, 139
  - no router rip, 155
    - configuration command, 155
  - no router zebra, 148
    - configuration command, 148
  - no router-info, 149
    - configuration command, 149
  - no rt vpn import|export|both [RTLIST...], 92
    - configuration command, 92
  - no security passwords min-length, 4
    - configuration command, 4
  - no set-overload-bit, 126
    - configuration command, 126
  - no spf-interval, 127
    - configuration command, 127
  - no spf-interval [level-1 | level-2], 127
    - configuration command, 127
  - no subject-alt-name, 189
  - no subject-alt-name LINE
    - configuration command, 189
  - no system tune profile, 49
  - no system tune profile TPROF
    - configuration command, 49
  - no system update enable, 29
    - configuration command, 29
  - no timers basic, 161
    - configuration command, 161
  - no timers throttle spf, 140, 153
    - configuration command, 140, 153
  - no version, 156
    - configuration command, 156
  - ntp authentication, 35
    - configuration command, 35
  - ntp authentication-key, 35
  - ntp authentication-key (1-65535) sha1 WORD
    - configuration command, 35
  - ntp server SERVER, 34
  - ntp server SERVER [OPTIONS]
    - configuration command, 34
  - ntp-server NTP ..., 43
- ## O
- offset-list ACCESS-LIST (*in|out*), 159
    - configuration command, 159
  - offset-list ACCESS-LIST (*in|out*) IFNAME, 159
    - configuration command, 159
  - on-match goto N, 25
    - configuration command, 25
  - on-match next, 25
    - configuration command, 25
  - ospf abr-type TYPE, 139
    - configuration command, 139
  - OSPF Areas overview, 133
  - OSPF Hello Protocol, 132
  - OSPF LSA overview, 132
  - ospf opaque-lsa, 149
    - configuration command, 149
  - ospf rfc1583compatibility, 140
    - configuration command, 140
  - ospf router-id A.B.C.D, 139
    - configuration command, 139
  - ospf6 router-id A.B.C.D, 152
    - configuration command, 152
- ## P
- passive-interface (*IFNAME|default*), 123, 156
    - configuration command, 123, 156
  - passive-interface INTERFACE, 140
    - configuration command, 140
  - password, 3
    - configuration command, 3
  - pce address <A.B.C.D>, 149
    - configuration command, 149
  - pce domain as (0-65535), 149
    - configuration command, 149
  - pce flag BITPATTERN, 149
    - configuration command, 149
  - pce neighbor as (0-65535), 149
    - configuration command, 149
  - pce scope BITPATTERN, 149
    - configuration command, 149

peer <A.B.C.D|X:X::X:X>  
 [{multihop|local-address  
 <A.B.C.D|X:X::X:X>|interface  
 IFNAME|vrf NAME}], 54  
 configuration command, 54

peer PEER, 201  
 configuration command, 201

police BPS [NORMALBURST [MAXBURST]]  
 conform-action ACTION exceed-action  
 ACTION [violate-action ACTION], 176  
 configuration command, 176

policy-map NAME, 176  
 configuration command, 176

poll sleep, 51

poll sleep (0-10000)  
 configuration command, 51

pre-shared-key LINE, 201  
 configuration command, 201

proactive-arp, 142  
 configuration command, 142

profile BFDPROF, 55  
 configuration command, 55

profile WORD, 54  
 configuration command, 54

proposal IKEPOSAL, 202  
 configuration command, 202

public-key LINE [base64], 195  
 configuration command, 195

purge-originator, 126  
 configuration command, 126

pw-id (1-4294967295), 186  
 configuration command, 186

## R

rd vpn export AS:NN|IP:nn, 91  
 configuration command, 91

read-quanta (1-10), 94  
 configuration command, 94

receive-interval (10-60000), 54  
 configuration command, 54

record netflow <ipv4|ipv6> prefix-port, 41  
 configuration command, 41

redistribute (kernel|connected|static|rip|bgp), 147  
 configuration command, 147

redistribute (kernel|connected|static|rip|bgp)  
 metric (0-16777214), 147  
 configuration command, 147

redistribute (kernel|connected|static|rip|bgp)  
 metric (0-16777214) route-map WORD,  
 147  
 configuration command, 147

redistribute (kernel|connected|static|rip|bgp)  
 metric-type (1|2), 147  
 configuration command, 147

redistribute (kernel|connected|static|rip|bgp)  
 metric-type (1|2) metric (0-16777214),  
 147  
 configuration command, 147

redistribute (kernel|connected|static|rip|bgp)  
 metric-type (1|2) metric  
 (0-16777214) route-map WORD, 147  
 configuration command, 147

redistribute (kernel|connected|static|rip|bgp)  
 metric-type (1|2) route-map WORD, 147  
 configuration command, 147

redistribute (kernel|connected|static|rip|bgp)  
 ROUTE-MAP, 147  
 configuration command, 147

redistribute bgp, 124, 158  
 configuration command, 124, 158

redistribute bgp metric (1-4294967295)  
 (0-4294967295) (0-255) (1-255) (1-  
 65535), 124

redistribute bgp metric (0-16), 158  
 configuration command, 158

redistribute bgp metric (1-4294967295)  
 (0-4294967295) (0-255) (1-255) (1-  
 65535)  
 configuration command, 124

redistribute bgp route-map ROUTE-MAP, 158  
 configuration command, 158

redistribute connected, 75, 124, 154, 157  
 configuration command, 75, 124, 154, 157

redistribute connected metric (0-16), 157  
 configuration command, 157

redistribute connected metric  
 (1-4294967295) (0-4294967295)  
 (0-255) (1-255) (1-65535), 124  
 configuration command, 124

redistribute connected route-map ROUTE-MAP,  
 157  
 configuration command, 157

redistribute kernel, 75, 124, 157  
 configuration command, 75, 124, 157

redistribute kernel metric (0-16), 157  
 configuration command, 157

redistribute kernel metric (1-4294967295)  
 (0-4294967295) (0-255) (1-255) (1-  
 65535), 124  
 configuration command, 124

redistribute kernel route-map ROUTE-MAP, 157  
 configuration command, 157

redistribute ospf, 76, 124, 157  
 configuration command, 76, 124, 157

redistribute ospf metric (0-16), 157  
 configuration command, 157

redistribute ospf metric (1-4294967295)  
 (0-4294967295) (0-255) (1-255) (1-

- 65535), 124
- configuration command, 124
- redistribute ospf route-map ROUTE-MAP, 157
  - configuration command, 157
- redistribute rip, 75
  - configuration command, 75
- redistribute ripng, 154
  - configuration command, 154
- redistribute static, 75, 124, 154, 157
  - configuration command, 75, 124, 154, 157
- redistribute static metric (0-16), 157
  - configuration command, 157
- redistribute static metric (1-4294967295) (0-4294967295) (0-255) (1-255) (1-65535), 124
  - configuration command, 124
- redistribute static route-map ROUTE-MAP, 157
  - configuration command, 157
- redistribute vnc, 76
  - configuration command, 76
- remark LINE .., 178
  - configuration command, 178
- RFC
  - RFC 1195, 125
  - RFC 1583, 140
  - RFC 1771, 62, 107
  - RFC 1930, 62
  - RFC 1997, 83
  - RFC 1998, 83
  - RFC 2080, 162
  - RFC 2131, 42
  - RFC 2283, 63
  - RFC 2328, 131, 140
  - RFC 2439, 68
  - RFC 2462, 40
  - RFC 2740, 152
  - RFC 2842, 63
  - RFC 2858, 62
  - RFC 3031, 119
  - RFC 3107, 62
  - RFC 3137, 141
  - RFC 3345, 70
  - RFC 3509, 140, 143
  - RFC 3765, 84
  - RFC 4191, 40
  - RFC 4271, 62
  - RFC 4364, 62, 91
  - RFC 4447, 119
  - RFC 4659, 62, 91
  - RFC 4861, 40
  - RFC 4970, 149
  - RFC 5036, 119
  - RFC 5088, 150
  - RFC 5303, 129
  - RFC 5308, 125
  - RFC 5561, 119
  - RFC 5880, 53
  - RFC 5881, 53
  - RFC 5883, 53-55
  - RFC 5919, 119
  - RFC 6232, 127
  - RFC 6275, 40
  - RFC 6667, 119
  - RFC 6720, 119
  - RFC 7552, 119, 120
  - RFC 7611, 83
  - RFC 7938, 115
  - RFC 7999, 84
  - RFC 8092, 89
  - RFC 8106, 40
  - RFC 8195, 89
  - RFC 8277, 62
  - RFC 8326, 83
- route A.B.C.D/M, 158
  - configuration command, 158
- route NETWORK, 163
  - configuration command, 163
- route-map optimization, 26
  - configuration command, 26
- route-map ROUTE-MAP-NAME (permit|deny) ORDER, 23
  - configuration command, 23
- route-map vpn import|export MAP, 92
  - configuration command, 92
- router bgp AS-NUMBER view NAME, 65
  - configuration command, 65
- router bgp ASN, 64
  - configuration command, 64
- router bgp ASN vrf VRFNAME, 64
  - configuration command, 64
- router eigrp (1-65535) [vrf NAME], 123
  - configuration command, 123
- router ospf [(1-65535)] vrf NAME, 139
  - configuration command, 139
- router ospf6, 152
  - configuration command, 152
- router rip, 155
  - configuration command, 155
- router ripng, 163
  - configuration command, 163
- router zebra, 148, 163
  - configuration command, 148, 163
- router-info [as | area], 149
  - configuration command, 149
- rsakeypair, 189
  - rsakeypair KEY
    - configuration command, 189
- rt vpn import|export|both RTLIST..., 91

configuration command, 91

## S

security passwords min-length, 4

configuration command, 4

service password-encryption, 8

configuration command, 8

service-policy PMAP in, 177

configuration command, 177

Set Actions, 22

set as-path prepend AS\_PATH, 25

configuration command, 25

set comm-list WORD delete, 86

configuration command, 86

set community <none|COMMUNITY> additive, 85

configuration command, 85

set community COMMUNITY, 25

configuration command, 25

set extcommunity bandwidth <((1-25600)

| cumulative | num-multipaths>

[non-transitive], 89

configuration command, 89

set extcommunity rt EXTCOMMUNITY, 89

configuration command, 89

set extcommunity soo EXTCOMMUNITY, 89

configuration command, 89

set ip next-hop A.B.C.D, 160

configuration command, 160

set ip next-hop IPV4\_ADDRESS, 24

configuration command, 24

set ip next-hop peer-address, 24

configuration command, 24

set ip next-hop unchanged, 24

configuration command, 24

set ipv6 next-hop global IPV6\_ADDRESS, 24

configuration command, 24

set ipv6 next-hop local IPV6\_ADDRESS, 25

configuration command, 25

set ipv6 next-hop peer-address, 24

configuration command, 24

set ipv6 next-hop prefer-global, 24

configuration command, 24

set large-community LARGE-COMMUNITY, 90

configuration command, 90

set large-community LARGE-COMMUNITY

additive, 90

configuration command, 90

set large-community LARGE-COMMUNITY

LARGE-COMMUNITY, 90

configuration command, 90

set local-preference +LOCAL\_PREF, 24

configuration command, 24

set local-preference -LOCAL\_PREF, 25

configuration command, 25

set local-preference LOCAL\_PREF, 24

configuration command, 24

set metric (0-4294967295), 160

configuration command, 160

set metric [+|-](0-4294967295), 147, 154

configuration command, 147, 154

set mode <rr|xor|active-backup|broadcast|lacp>

<12|123|134>, 209

configuration command, 209

set origin ORIGIN <egp|igp|incomplete>, 25

configuration command, 25

set security-association lifetime second

(120-28800), 203

configuration command, 203

set tag TAG, 24

configuration command, 24

set weight WEIGHT, 25

configuration command, 25

set-overload-bit, 126

configuration command, 126

show bfd [vrf NAME\$vrf\_name] peer

<WORD\$label|<A.B.C.D|X:X::X:X>\$peer

[{multihop|local-address

<A.B.C.D|X:X::X:X>\$local|interface

IFNAME\$ifname}]> [json], 54

configuration command, 54

show bfd [vrf NAME] peers brief [json], 54

configuration command, 54

show bfd [vrf NAME] peers [json], 54

configuration command, 54

show bgp <afi> <safi> neighbors WORD

bestpath-routes [json] [wide], 80

configuration command, 80

show bgp <ipv4|ipv6>

<unicast|multicast|vpn|labeled-unicast>

95

configuration command, 95

show bgp community-list [NAME detail], 85

configuration command, 85

show bgp extcommunity-list, 89

configuration command, 89

show bgp extcommunity-list NAME detail, 89

configuration command, 89

show bgp ipv4 vpn summary, 97

configuration command, 97

show bgp ipv4|ipv6 regexp LINE, 97

configuration command, 97

show bgp ipv6 vpn summary, 97

configuration command, 97

show bgp large-community-list, 90

configuration command, 90

show bgp large-community-list NAME detail, 90

configuration command, 90

show bgp listeners, 93

configuration command, 93  
 show bgp statistics-all, 96  
   configuration command, 96  
 show bgp update-groups statistics, 97  
   configuration command, 97  
 show bgp update-groups SUBGROUP-ID  
   [advertise-queue|advertised-routes|packets], 97  
 show bgp update-groups  
   [advertise-queue|advertised-routes|packets], 97  
   configuration command, 97  
 show bgp X:X::X:X [wide], 95  
   configuration command, 95  
 show bgp [afi] [safi], 95  
   configuration command, 95  
 show bgp [afi] [safi] dampening  
   dampened-paths, 95  
   configuration command, 95  
 show bgp [afi] [safi] dampening  
   flap-statistics, 95  
   configuration command, 95  
 show bgp [afi] [safi] neighbor [PEER], 95  
   configuration command, 95  
 show bgp [afi] [safi] statistics, 95  
   configuration command, 95  
 show bgp [afi] [safi] summary, 95  
   configuration command, 95  
 show bgp [afi] [safi] summary established  
   [json], 95  
   configuration command, 95  
 show bgp [afi] [safi] summary failed [json],  
   95  
   configuration command, 95  
 show bgp [wide], 94  
   configuration command, 94  
 show bridge (/-65535), 207  
   configuration command, 207  
 show clock, 8  
 show clock [json]  
   configuration command, 8  
 show command history, 9  
   configuration command, 9  
 show crypto key, 194  
 show crypto key [[KEY] [json]] [ssh]  
   configuration command, 194  
 show crypto pki certificate, 193  
 show crypto pki certificate [CA]  
   configuration command, 193  
 show daemons status, 8  
   configuration command, 8  
 show debug, 93  
   configuration command, 93  
 show debugging eigrp, 125  
   configuration command, 125  
   show debugging isis, 131  
     configuration command, 131  
   show debugging ospf, 151  
     configuration command, 151  
   show debugging rip, 162  
     configuration command, 162  
   show debugging ripng, 163  
     configuration command, 163  
   show hardware, 14  
   show hardware {cpu | disk | memory}  
     configuration command, 14  
   show ip access-list [NAME], 180  
     configuration command, 180  
   show ip arp, 205  
   show ip arp [IFNAME]  
     configuration command, 205  
   show ip bgp A.B.C.D [wide], 94  
     configuration command, 94  
   show ip bgp large-community-info, 90  
     configuration command, 90  
   show ip bgp [wide], 94  
     configuration command, 94  
   show ip dhcp binding, 44  
   show ip dhcp binding [<DHCP4POOL|A.B.C.D>]  
     configuration command, 44  
   show ip dhcp pool, 44  
     configuration command, 44  
   show ip eigrp [vrf NAME] interface, 125  
     configuration command, 125  
   show ip eigrp [vrf NAME] topology, 125  
     configuration command, 125  
   show ip igmp groups, 168  
     configuration command, 168  
   show ip igmp groups retransmissions, 168  
     configuration command, 168  
   show ip igmp interface, 168  
     configuration command, 168  
   show ip igmp join, 168  
     configuration command, 168  
   show ip igmp sources, 168  
     configuration command, 168  
   show ip igmp sources retransmissions, 168  
     configuration command, 168  
   show ip igmp statistics, 169  
     configuration command, 169  
   show ip mroute vrf all count [json], 169  
     configuration command, 169  
   show ip mroute vrf all summary [json], 169  
     configuration command, 169  
   show ip mroute [vrf NAME] count [json], 169  
     configuration command, 169  
   show ip mroute [vrf NAME] summary [json], 169  
     configuration command, 169



show ip mroute [vrf NAME] [A.B.C.D  
 [A.B.C.D]] [fill] [json], 169  
 configuration command, 169

show ip multicast, 169  
 configuration command, 169

show ip multicast count vrf all [json], 170  
 configuration command, 170

show ip multicast count [vrf NAME] [json],  
 170  
 configuration command, 170

show ip ospf, 148  
 configuration command, 148

show ip ospf database, 148  
 configuration command, 148

show ip ospf database (asbr-  
 summary|external|network|router|summary),  
 148  
 configuration command, 148

show ip ospf database  
 (asbr-summary|external|network|router|summary)  
 ospf neighbor ADV-ROUTER, 148  
 configuration command, 148

show ip ospf database  
 (asbr-summary|external|network|router|summary)  
 ospf route, 149  
 LINK-STATE-ID, 148  
 configuration command, 148

show ip ospf database  
 (asbr-summary|external|network|router|summary)  
 ospf router-info pce, 150  
 LINK-STATE-ID adv-router ADV-ROUTER,  
 148  
 configuration command, 148

show ip ospf database  
 (asbr-summary|external|network|router|summary)  
 ospf self-originate, 148  
 LINK-STATE-ID self-originate, 148  
 configuration command, 148

show ip ospf database (opaque-link|opaque-  
 area|opaque-external), 149  
 configuration command, 149

show ip ospf database  
 (opaque-link|opaque-area|opaque-external)  
 adv-router ADV-ROUTER, 149  
 configuration command, 149

show ip ospf database  
 (opaque-link|opaque-area|opaque-external)  
 LINK-STATE-ID, 149  
 configuration command, 149

show ip ospf database  
 (opaque-link|opaque-area|opaque-external)  
 LINK-STATE-ID adv-router ADV-ROUTER,  
 149  
 configuration command, 149

show ip ospf database configuration command, 149

show ip ospf database  
 (opaque-link|opaque-area|opaque-external)  
 LINK-STATE-ID self-originate, 149  
 configuration command, 149

show ip ospf database max-age, 148  
 configuration command, 148

show ip ospf database self-originate, 148  
 configuration command, 148

show ip ospf interface [INTERFACE], 148  
 configuration command, 148

show ip ospf neighbor, 148  
 configuration command, 148

show ip ospf neighbor detail, 148  
 configuration command, 148

show ip ospf neighbor INTERFACE, 148  
 configuration command, 148

show ip ospf neighbor INTERFACE detail, 148  
 configuration command, 148

show ip ospf router-info, 150  
 configuration command, 150

show ip pim assert, 169  
 configuration command, 169

show ip pim assert-internal, 169  
 configuration command, 169

show ip pim assert-metric, 169  
 configuration command, 169

show ip pim assert-winner-metric, 169  
 configuration command, 169

show ip pim bsm-database, 170  
 configuration command, 170

show ip pim bsr, 170  
 configuration command, 170

show ip pim bsrp-info, 170  
 configuration command, 170

show ip pim group-type, 169  
 configuration command, 169

show ip pim interface, 169  
 configuration command, 169

show ip pim join  
 configuration command, 169

show ip pim local-membership, 169  
 configuration command, 169

show ip pim mlag summary, 170  
 configuration command, 170

show ip pim mlag summary [json], 169

configuration command, 169  
 show ip pim mlag upstream  
   configuration command, 170  
 show ip pim mlag [vrf NAME|all] interface  
   [detail|WORD] [json]  
   configuration command, 169  
 show ip pim mlag [vrf NAME] interface  
   [detail|WORD] [json], 169  
 show ip pim neighbor, 169  
   configuration command, 169  
 show ip pim nexthop, 170  
   configuration command, 170  
 show ip pim nexthop-lookup, 170  
   configuration command, 170  
 show ip pim rp-info, 170  
   configuration command, 170  
 show ip pim rpf, 170  
   configuration command, 170  
 show ip pim secondary, 170  
   configuration command, 170  
 show ip pim state, 170  
   configuration command, 170  
 show ip pim upstream  
   configuration command, 170  
 show ip pim upstream-join-desired, 170  
   configuration command, 170  
 show ip pim upstream-rpf, 170  
   configuration command, 170  
 show ip pim [vrf NAME] join [A.B.C.D  
   [A.B.C.D]] [json], 169  
 show ip pim [vrf NAME] mlag upstream  
   [A.B.C.D [A.B.C.D]] [json], 170  
 show ip pim [vrf NAME] upstream [A.B.C.D  
   [A.B.C.D]] [json], 170  
 show ip prefix-list, 21  
   configuration command, 21  
 show ip prefix-list detail, 21  
   configuration command, 21  
 show ip prefix-list detail NAME, 21  
   configuration command, 21  
 show ip prefix-list NAME, 21  
   configuration command, 21  
 show ip prefix-list NAME A.B.C.D/M, 21  
   configuration command, 21  
 show ip prefix-list NAME A.B.C.D/M  
   first-match, 21  
   configuration command, 21  
 show ip prefix-list NAME A.B.C.D/M longer, 21  
   configuration command, 21  
 show ip prefix-list NAME seq NUM, 21  
   configuration command, 21  
 show ip prefix-list summary, 21  
   configuration command, 21  
 show ip prefix-list summary NAME, 21  
   configuration command, 21  
 show ip rip, 161  
   configuration command, 161  
 show ip rip status, 161  
   configuration command, 161  
 show ip ripng, 163  
   configuration command, 163  
 show ip rpf, 170  
   configuration command, 170  
 show ip ssh client known-host  
   <A.B.C.D|X:X::X:X|HOST>, 7  
   configuration command, 7  
 show ipv6 ospf6, 154  
   configuration command, 154  
 show ipv6 ospf6 database, 154  
   configuration command, 154  
 show ipv6 ospf6 interface, 154  
   configuration command, 154  
 show ipv6 ospf6 neighbor, 154  
   configuration command, 154  
 show ipv6 ospf6 request-list A.B.C.D, 154  
   configuration command, 154  
 show ipv6 ospf6 zebra, 154  
   configuration command, 154  
 show ipv6 route ospf6, 154  
   configuration command, 154  
 show isis database, 130  
   configuration command, 130  
 show isis database <LSP id> [detail], 130  
   configuration command, 130  
 show isis database detail <LSP id>, 130  
   configuration command, 130  
 show isis database [detail], 130  
   configuration command, 130  
 show isis hostname, 129  
   configuration command, 129  
 show isis interface, 129  
   configuration command, 129  
 show isis interface <interface name>, 129  
   configuration command, 129  
 show isis interface detail, 129  
   configuration command, 129  
 show isis neighbor, 129  
   configuration command, 129  
 show isis neighbor <System Id>, 129  
   configuration command, 129  
 show isis neighbor detail, 129  
   configuration command, 129  
 show isis route [level-1|level-2], 130  
   configuration command, 130  
 show isis summary, 129  
   configuration command, 129  
 show isis topology, 130  
   configuration command, 130

- show isis topology [level-1|level-2], 130
  - configuration command, 130
- show license, 46
  - configuration command, 46
- show log all [follow], 28
  - configuration command, 28
- show log frr [follow], 28
  - configuration command, 28
- show log ipsec [follow], 28
  - configuration command, 28
- show log kernel [follow], 28
  - configuration command, 28
- show log mender [follow], 28
  - configuration command, 28
- show log ntpd [follow], 28
  - configuration command, 28
- show log snmpd [follow], 28
  - configuration command, 28
- show log soolog [follow], 28
  - configuration command, 28
- show log ssh [follow], 28
  - configuration command, 28
- show log vpp [follow], 28
  - configuration command, 28
- show login blocked-ips, 5
  - configuration command, 5
- show login failures, 4
  - configuration command, 4
- show memory control-plane, 16
  - configuration command, 16
- show memory control-plane details, 16
  - configuration command, 16
- show mpls ldp discovery [detail], 121
  - configuration command, 121
- show mpls ldp ipv4 discovery [detail], 121
  - configuration command, 121
- show mpls ldp ipv4 interface, 121
  - configuration command, 121
- show mpls ldp ipv4|ipv6 binding, 121
  - configuration command, 121
- show mpls ldp ipv6 discovery [detail], 121
  - configuration command, 121
- show mpls ldp ipv6 interface, 121
  - configuration command, 121
- show mpls ldp neighbor [A.B.C.D], 121
  - configuration command, 121
- show mpls ldp neighbor [A.B.C.D] capabilities, 121
  - configuration command, 121
- show mpls ldp neighbor [A.B.C.D] detail, 121
  - configuration command, 121
- show ntp sources, 35
- show ntp sources stats, 36
  - configuration command, 36
- show ntp sources [json]
  - configuration command, 35
- show policy-map [NAME], 177
  - configuration command, 177
- show processes, 9
  - configuration command, 9
- show processes detailed process-id, 12
- show processes detailed process-id (0-1000000)
  - configuration command, 12
- show processes memory, 12
  - configuration command, 12
- show route-map [WORD], 23
  - configuration command, 23
- show system service status SERVICE, 32
  - configuration command, 32
- show thread cpu control-plane, 17
- show thread cpu control-plane [details [r|w|t|e|x]]
  - configuration command, 17
- show users, 5
  - configuration command, 5
- show version, 9
  - configuration command, 9
- show vrf, 182
  - configuration command, 182
- show wireguard, 196
- show wireguard stats, 198
- show wireguard [(1-1024) PEER] stats [json]
  - configuration command, 198
- show wireguard [(1-1024) PEER] [json]
  - configuration command, 196
- show [ip] bgp <ipv4|ipv6> community, 96
  - configuration command, 96
- show [ip] bgp <ipv4|ipv6> community COMMUNITY, 96
  - configuration command, 96
- show [ip] bgp <ipv4|ipv6> community COMMUNITY exact-match, 96
  - configuration command, 96
- show [ip] bgp <ipv4|ipv6> community-list WORD, 96
  - configuration command, 96
- show [ip] bgp <ipv4|ipv6> community-list WORD exact-match, 96
  - configuration command, 96
- show [ip] bgp <ipv4|ipv6> large-community, 96
  - configuration command, 96
- show [ip] bgp <ipv4|ipv6> large-community LARGE-COMMUNITY, 96
  - configuration command, 96
- show [ip] bgp <ipv4|ipv6> large-community LARGE-COMMUNITY exact-match, 96
  - configuration command, 96

- show [ip] bgp <ipv4|ipv6> large-community  
LARGE-COMMUNITY json, 96  
configuration command, 96
- show [ip] bgp <ipv4|ipv6>  
large-community-list WORD, 96  
configuration command, 96
- show [ip] bgp <ipv4|ipv6>  
large-community-list WORD  
exact-match, 96  
configuration command, 96
- show [ip] bgp <ipv4|ipv6>  
large-community-list WORD json, 96  
configuration command, 96
- show [ip] bgp ipv4 vpn, 97  
configuration command, 97
- show [ip] bgp ipv6 vpn, 97  
configuration command, 97
- show [ip] bgp regexp LINE, 95  
configuration command, 95
- show [ip] bgp summary, 95  
configuration command, 95
- show [ip] bgp view NAME, 65  
configuration command, 65
- simple: debug mpls ldp KIND, 122
- simple: no debug mpls ldp KIND, 122
- snmp-server user USER auth <md5|sha>  
PASSWORD [priv des56 PRIV], 33  
configuration command, 33
- source A.B.C.D, 40  
configuration command, 40
- source-ip, 185
- source-ip <A.B.C.D|X:X::X:X>  
configuration command, 185
- spf-interval (1-120), 127  
configuration command, 127
- spf-interval [level-1 | level-2] (1-120), 127  
configuration command, 127
- subject-alt-name, 189
- subject-alt-name LINE  
configuration command, 189
- subject-name, 189
- subject-name LINE...  
configuration command, 189
- system config backup list local, 31  
configuration command, 31
- system config backup list removable-storage,  
31  
configuration command, 31
- system config backup list ssh HOST USER  
PATH, 30  
configuration command, 30
- system config backup local NAME, 31  
configuration command, 31
- system config backup removable-storage NAME,  
31  
configuration command, 31
- system config backup ssh HOST USER PATH, 30  
configuration command, 30
- system config restore local NAME, 32  
configuration command, 32
- system config restore removable-storage  
NAME, 31  
configuration command, 31
- system config restore ssh HOST USER PATH, 31  
configuration command, 31
- system service enable soomon, 32  
configuration command, 32
- system service restart SERVICE, 32  
configuration command, 32
- system tune apply, 53
- system tune apply default  
configuration command, 53
- system tune apply PROFILE  
configuration command, 53
- system tune profile, 49
- system tune profile TPROF  
configuration command, 49
- system update enable, 29  
configuration command, 29
- system update inventory-poll-interval (5-  
2147483647), 29  
configuration command, 29
- system update offline commit, 30  
configuration command, 30
- system update offline install ARTIFACT, 30  
configuration command, 30
- system update offline list, 30  
configuration command, 30
- system update server-url WORD, 29  
configuration command, 29
- system update update-poll-interval (5-  
2147483647), 29  
configuration command, 29
- ## T
- table-map ROUTE-MAP-NAME, 76  
configuration command, 76
- tcp syn-flood limit, 33
- tcp syn-flood limit (1-4294967295)  
configuration command, 33
- timers basic UPDATE TIMEOUT GARBAGE, 161  
configuration command, 161
- timers throttle spf (0-600000) (0-600000) (0-  
600000), 140  
configuration command, 140
- timers throttle spf DELAY INITIAL-HOLDTIME  
MAX-HOLDTIME, 152

configuration command, 152  
 transmit-interval (10-60000), 54  
     configuration command, 54  
 transport udp (1-65535), 40  
     configuration command, 40  
 tunnel destination <A.B.C.D|X:X::X:X>, 183  
     configuration command, 183  
 tunnel mode gre, 183  
     configuration command, 183  
 tunnel mode gre multipoint, 183  
     configuration command, 183  
 tunnel mode ipip, 183  
     configuration command, 183  
 tunnel mode ipip multipoint, 183  
     configuration command, 183  
 tunnel protection ipsec profile  
     IPSECPROFILE, 183  
     configuration command, 183  
 tunnel source, 183  
 tunnel source <A.B.C.D|X:X::X:X>  
     configuration command, 183  
 tunnel vrf VRF, 183

## U

update-delay MAX-DELAY, 76  
     configuration command, 76  
 update-delay MAX-DELAY ESTABLISH-WAIT, 76  
     configuration command, 76  
 user password, 4  
     configuration command, 4  
 username USER, 6  
     configuration command, 6

## V

version VERSION, 156  
     configuration command, 156  
 vrf (VRF\_NAME), 181  
     configuration command, 181  
 vrf VRF, 195  
     configuration command, 195

## W

wireguard peer PEER, 195  
     configuration command, 195  
 wireguard port (1000-65535), 195  
     configuration command, 195  
 wireguard private-key X25519KEY, 195  
     configuration command, 195  
 wireguard source A.B.C.D, 195  
     configuration command, 195  
 write file, 9  
     configuration command, 9  
 write terminal, 9  
     configuration command, 9